



YASKAWA

YASKAWA AC Drive-Option Card Complementary Type PG Installation Manual

Type PG-B3

To properly use the product, read this manual thoroughly and retain for easy reference, inspection, and maintenance. Ensure the end user receives this manual.

安川インバータ オプションカード コンプリメンタリタイプ PG 取扱説明書

形式 PG-B3

製品を安全にお使い頂くために、この取扱説明書を必ずお読みください。
また、本書をお手元に保管していただくとともに、最終的に本製品をご使用になるユーザー様のお手元に確実に届けられるよう、お取り計らい願います。

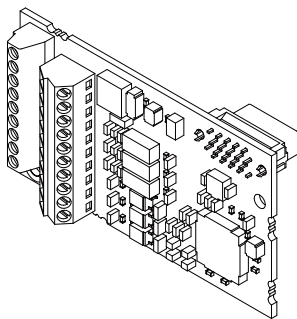

This Page Intentionally Blank



Table of Contents

1 PREFACE	4
2 PRODUCT OVERVIEW	7
3 OPTION CARD COMPONENTS	9
4 ELECTRICAL INSTALLATION	10
5 RELATED PARAMETERS	20
6 TROUBLESHOOTING	23
7 SPECIFICATIONS & WARRANTY INFORMATION	27

Copyright © 2008 YASKAWA ELECTRIC CORPORATION

All rights reserved. No part of this publication may be reproduced, stored in a retrieval system, or transmitted, in any form or by any means, mechanical, electronic, photocopying, recording, or otherwise, without the prior written permission of Yaskawa. No patent liability is assumed with respect to the use of the information contained herein. Moreover, because Yaskawa is constantly striving to improve its high-quality products, the information contained in this manual is subject to change without notice. Every precaution has been taken in the preparation of this manual. Yaskawa assumes no responsibility for errors or omissions. Neither is any liability assumed for damages resulting from the use of the information contained in this publication.

1 Preface

Yaskawa manufactures products used as components in a wide variety of industrial systems and equipment. The selection and application of Yaskawa products remain the responsibility of the equipment manufacturer or end user. Yaskawa accepts no responsibility for the way its products are incorporated into the final system design. Under no circumstances should any Yaskawa product be incorporated into any product or design as the exclusive or sole safety control. Without exception, all controls should be designed to detect faults dynamically and fail safely under all circumstances. All systems or equipment designed to incorporate a product manufactured by Yaskawa must be supplied to the end user with appropriate warnings and instructions as to the safe use and operation of that part. Any warnings provided by Yaskawa must be promptly provided to the end user. Yaskawa offers an express warranty only as to the quality of its products in conforming to standards and specifications published in the Yaskawa manual. **NO OTHER WARRANTY, EXPRESS OR IMPLIED, IS OFFERED.** Yaskawa assumes no liability for any personal injury, property damage, losses, or claims arising from misapplication of its products.

◆ Applicable Documentation

This instruction manual has been written for the items listed below. Use this option card for its intended purpose only.

Option Card

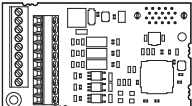
	<p>YASKAWA AC Drive-Option Card Complementary PG: PG-B3 Installation Manual (this book) Document Number: TOBP C730600 36</p> <p>Read this manual first. It contains information required to install the option card and set up related drive parameters.</p>
--	---

Drive

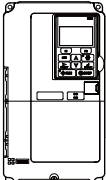
	<p>Refer to the manual of the drive this option card is being used with. The manual for the drive covers basic installation, wiring, operation procedures, functions, troubleshooting, and maintenance information. It also includes important information on parameter settings and how to tune the drive. To obtain instruction manuals for Yaskawa products access these sites: Europe: http://www.yaskawa.eu.com Japan: http://www.e-mechatronics.com Other areas: contact a Yaskawa representative.</p>
--	---

◆ Registered Trademarks

- Company names and product names listed in this manual are the registered trademarks of those companies.

◆ Supplemental Safety Information

Read and understand this manual before installing, operating or servicing this option unit.

The option unit must be installed according to this manual and local codes.

The following conventions are used to indicate safety messages in this manual. Failure to heed these messages could result in serious or possibly even fatal injury or damage to the products or to related equipment and systems.

DANGER

Indicates a hazardous situation, which, if not avoided, will result in death or serious injury.

WARNING

Indicates a hazardous situation, which, if not avoided, could result in death or serious injury.

CAUTION

Indicates a hazardous situation, which, if not avoided, could result in minor or moderate injury.

NOTICE

Indicates an equipment damage message.

1 Preface

■ General Safety

General Precautions

- The diagrams in this section may include option units and drives without covers or safety shields to illustrate details. Be sure to reinstall covers or shields before operating any devices. The option board should be used according to the instructions described in this manual.
- Any illustrations, photographs, or examples used in this manual are provided as examples only and may not apply to all products to which this manual is applicable.
- The products and specifications described in this manual or the content and presentation of the manual may be changed without notice to improve the product and/or the manual.
- When ordering a new copy of the manual due to damage or loss, contact your Yaskawa representative or the nearest Yaskawa sales office and provide the manual number shown on the front cover.

DANGER

Heed the safety messages in this manual.

Failure to comply will result in death or serious injury.

The operating company is responsible for any injuries or equipment damage resulting from failure to heed the warnings in this manual.

NOTICE

Do not expose the drive to halogen group disinfectants.

Failure to comply may cause damage to the electrical components in the option unit

Do not pack the drive in wooden materials that have been fumigated or sterilized.

Do not sterilize the entire package after the product is packed.

2 Product Overview

◆ Regarding this Product



By installing this option card to a drive, the drive is able to read a feedback signal send from a pulse generator (PG) attached to the motor. This PG signal lets the drive know about any subtle variations in the load, and provides the drive with the data necessary for controlling the output frequency to maintain constant speed with a high degree of accuracy.

This card can read a maximum input frequency sent from the PG of 50 kHz. Select a PG with an output of maximum 20 kHz when operating at maximum speed.

This option card allows the user to connect a incremental encoder (PG) for motor speed feedback to the drive and take advantage of the drive's V/f with PG control mode, Closed Loop Vector control mode, and Closed Loop Vector for PM motors to obtain more accurate control and higher performance.

◆ Checking Package Contents

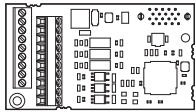
Table 1 Items Included with this Option Card

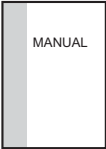
Package Contents	Option Card	Lead Lines (for grounding)	Screws (M3)	Manual (this book)
-				
Number of Items	1	2	3	1

- Inspect the Option Card for damage. If the Option Card appears damaged upon receipt, contact the shipper immediately.
- Verify receipt of the correct model by checking the model number printed on the Name plate of the Option Card. (see [Figure 1](#))
- If you have received the wrong model or the Option Card does not function properly, contact your supplier.

2 Product Overview

◆ Tools Required for Installation

A Phillips screwdriver PH1 (#1) is needed to install this option card.

Additionally a straight-edge screwdriver (blade depth: 0.4 mm, width: 2.5 mm) will be needed to wire the terminal block.

Note: Other tools are required for preparing encoder cables.

3 Option Card Components

◆ Option Card

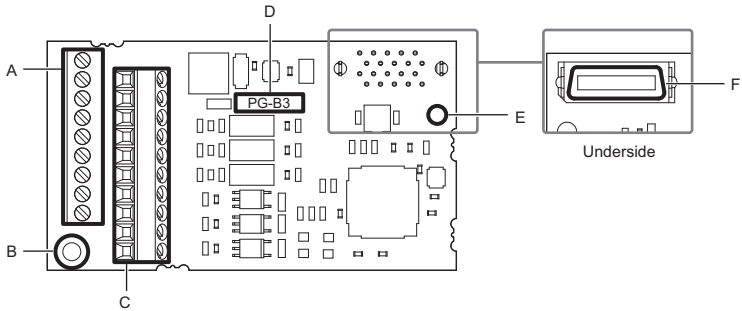

- A – Terminal block TB1
- B – Ground terminal (installation hole)
- C – Terminal block TB2
- D – Model number
- E – Installation hole
- F – Connector (CN5)

Figure 1 Option Card

◆ Terminal Block

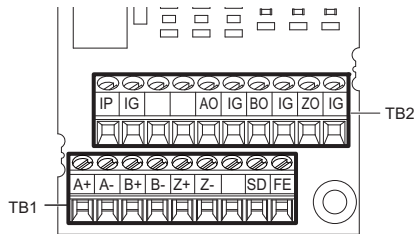

Figure 2 Terminal Block

4 Electrical Installation

◆ Safety Messages

DANGER

Electric Shock Hazard

Power to the drive must be shut off when installing this option card.

Even though the power has been shut off, voltage still remains in the drive's DC bus. Wait before removing the front cover once the drive has been turned off.

The CHARGE light on the drive will go out after voltage in the DC bus drops below 50 V, at which point it is safe to remove the front cover.

Due to the risk of electric shock, be sure that all LEDs have gone out and that the DC bus voltage has reached a safe level prior to performing any work on the drive.

WARNING

Electrical Shock Hazard

Do not allow unqualified personnel to perform work on the drive.

Failure to comply could result in death or serious injury.

Maintenance, inspection, and replacement of parts must be performed only by authorized personnel familiar with installation, adjustment and maintenance of AC drives and Option Cards.

NOTICE

Damage to Equipment

Observe proper electrostatic discharge procedures (ESD) when handling the option unit, drive, and circuit boards.

Failure to comply may result in ESD damage to circuitry.

Never shut the power off while the drive is outputting voltage.

Failure to comply may cause the application to operate incorrectly or damage the drive.

Do not operate damaged equipment.

Failure to comply may cause further damage to the equipment.

Do not connect or operate any equipment with visible damage or missing parts.

Properly connect all pins and connectors.

Failure to comply may prevent proper operation and possibly damage equipment.

4 Electrical Installation

◆ Installing the Option Card

This option card can be inserted into the either the CN5-B or CN5-C connectors located on the drive's control board. If only one option card is connected to the drive, use the CN5-C connector. If two option cards are connected, use both CN5-B and CN5-C.

See the drive manual for directions on removing the front cover.

1. Shut off power to the drive, wait the appropriate amount of time for voltage to dissipate, then remove the operator and front cover.
2. Insert the CN5 connector on the option card into the matching CN5 connector on the drive, then fasten it into place using one of the screws included with the option card.

Connect one of the lead lines using one of the screws to the ground terminal.

Two separate lead lines have been included with the option card. Use the longer one when the option card is plugged into connector CN5-C on the drive side. Use the shorter one if it is plugged into connector CN5-B.

Note: There are only two screw holes on the drive for ground terminals. If three option cards are connected, two of the lead lines will need to share the same ground terminal.

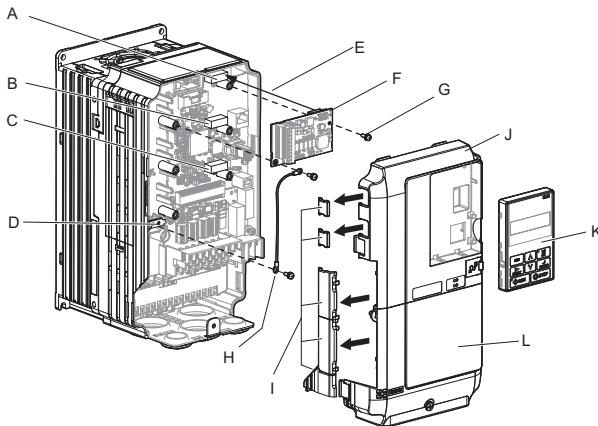

A – Connector CN5-C

B – Connector CN5-B

C – Connector CN5-A

D – Drive grounding terminal (FE)

E – Insert connector CN5 here

F – Option card

G – Mounting screw

H – Lead line

I – Use wire cutters to create an opening for cable lines

J – Front cover

K – Digital operator

L – Terminal cover

Figure 3 Installing an Option Card

- 3.** Wire the option card to the terminal block on the option card.
For wiring instructions, see [Complementary Output on page 15](#) and [Open-Collector Outputs on page 15](#).
In the drives CIMR-A□2A0004 to 0040 and 4A0002 to 0023 the PG cable might need to be routed through the top cover to the outside. In this case cut out the perforated openings at the left side of the drive top cover. Make sure no sharp edges that can damage the cable remain.
In the drives CIMR-A□2A0056 to 0211 and 4A0031 to 0165 the PG cable can be routed inside the drive.

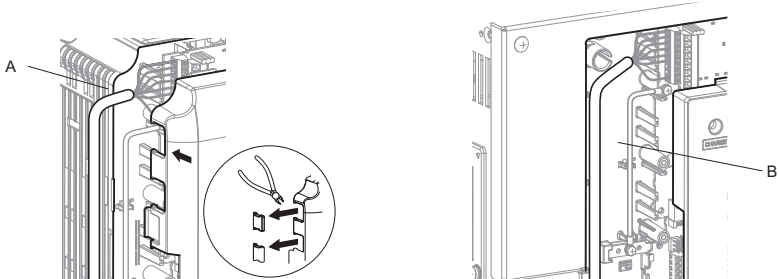

A – Wires should pass through the access hold provided on the left side of the front cover.
(CIMR-A□2A0004 to 0040, 4A0002 to 0023)

B – Use the open space provided inside the drive to route option card wiring.
(CIMR-A□2A0056 to 0211, 4A0031 to 0165)

Figure 4 Wiring space

- 4.** Place the front cover back onto the drive as it was before.

Note:

1. Take care when wiring the option card so that the front cover easily fits back onto the drive. Make sure a cable is not caught between the front cover and the drive when putting the cover back on.
2. The drive will not be used as NEMA Type1 if there is any exposed wiring outside the enclosure.

4 Electrical Installation

◆ Connection Diagram

Refer to [Figure 5](#) when wiring the terminal block on the option card.

- If using a single track encoder in the V/f with PG control mode, connect the pulse output from the PG to the option card and set parameter F1-37 in the drive to 0. If using a two track encoder, then connect the A and B pulse outputs on the PG to the option card and set F1-37 to 1.
- If using a two track encoder for the Close Loop Vector control mode, connect pulse outputs A and B from the encoder to the corresponding terminals on the option card.
- For a three track encoder, connect the A, B, and Z pulse outputs to the corresponding terminals on the option card.

A detailed description of the option board terminals can be found in [Terminal Functions on page 16](#).

For a description of the PG cable, see [PG Cables on page 17](#). For instructions on making your own cable, see [Wire Gauges and Tightening Torque on page 18](#).

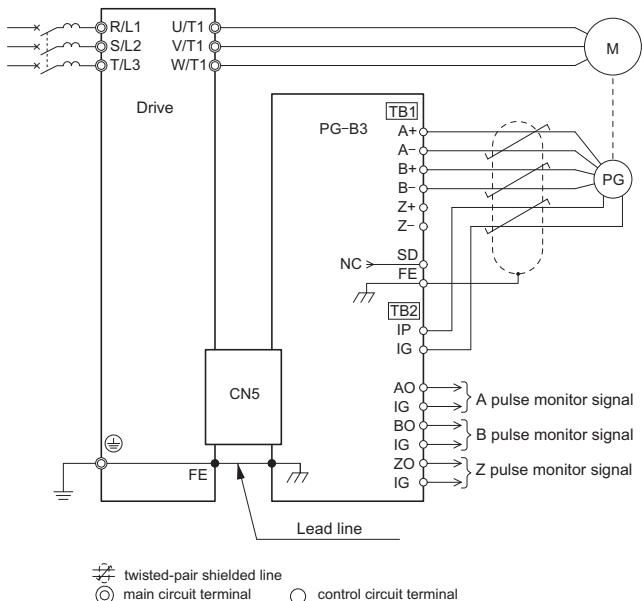

Figure 5 Wiring the Option Card and PG

Take the following steps to prevent erroneous operation caused by noise interference:

- Use shielded wire for the signal lines.
- Keep complementary output wiring under 100 m. Lines for open-collector output should kept under 50 m.
- Make sure that control lines to the option card, main circuit wiring, and power lines are separated from one another.

■ Interface Circuit

Complementary Output

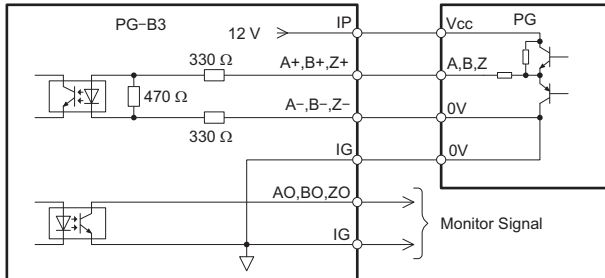

Figure 6 Complementary Outputs for the Interface Circuit

Open-Collector Outputs

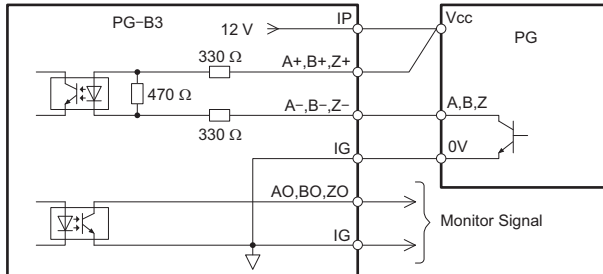

Figure 7 Open-Collector Outputs for the Interface Circuit

4 Electrical Installation

◆ Terminal Functions

Table 2 Terminal Functions

Terminal Block	Terminal	Function	Description
TB1	A+	A+ pulse signal input	<ul style="list-style-type: none"> Pulse signal inputs from the PG Signal inputs from complementary and open-collector outputs Signal level H level: 8 to 12 V L level: 2.0 V or less
	A-	A- inverse pulse input	
	B+	B+ pulse signal input	
	B-	B- inverse pulse input	
	Z+	Z+ pulse signal input	
	Z-	Z- inverse pulse input	
	SD	NC pin (open)	For use when cables shields should not be grounded
FE	Ground	Used for grounding shielded lines	
TB2	IP	PG power supply	<ul style="list-style-type: none"> Output voltage: 12.0 V \pm 5% Max output current: 200 mA </>
	IG	PG power supply common	
	AO	A pulse monitor signal	<ul style="list-style-type: none"> Outputs the monitor signal for the A, B, and Z pulses from the PG speed control card For open collector outputs from the option card Max voltage: 24 V Max current: 30 mA
	BO	B pulse monitor signal	
	ZO	Z pulse monitor signal	
	IG	Monitor signal common	

</> A separate power supply is needed if the PG requires more than 200 mA to operate. To continue operating through a momentary power loss, a back-up capacitor should be connected.

◆ PG Signal Output and Option Card Settings

With a two or three track encoder the motor rotation direction is determined by the pulse that leads. A PG signal with leading A pulse is considered as rotation in Forward direction (counter-clockwise when from the load side).

NOTICE: Make sure that the option card and PG have been set correctly to ensure that the motor operates as expected.

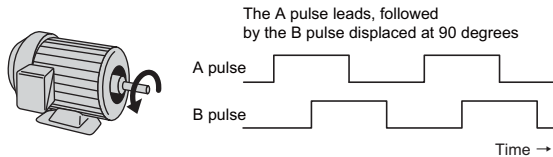

Figure 8 Displacement of A and B Pulses

After connecting the PG outputs to the option card, the direction can be checked by manually rotate the motor with the monitor on the drive.

If the monitor shows the forward direction as being the opposite of what you want, set parameter F1-05/F1-32 to 1 to switch the direction of how the option card reads pulses from the PG output.

◆ PG Cables

For cables running between the option card and the PG, Yaskawa recommends using a LMA-□□B-S185Y (complementary output) as show in [Figure 9](#).

For instructions on wiring the terminal block, see [Terminal Functions on page 16](#).

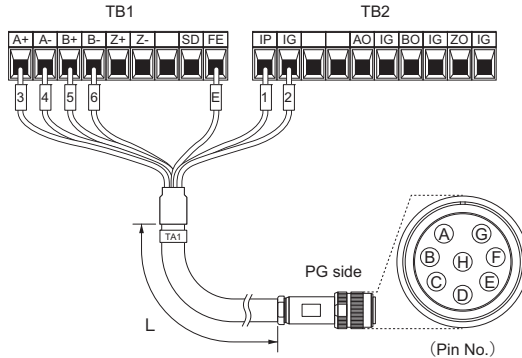

Figure 9 Wiring PG Cables

Table 3 Connecting the PG Cable

Option Card	PG Cable		
Terminal	Wire No.	Color	Pin No.
IP	1	Blue	C
IG	2	White	H
A+	3	Yellow	B
A-	4	White	G
B+	5	Green	A
B-	6	White	F
FE	E	N/A (shield)	D

Table 4 PG Cable Types

Length	Type	Length	Type
10 m	W5010	50 m	W5050
30 m	W5030	100 m	W5100

4 Electrical Installation

◆ Wire Gauges and Tightening Torque

Wire gauge specifications are listed below in [Table 5](#).

Yaskawa recommends using crimp terminals for easy of wiring and to ensure proper connection. Crimp terminal specifications can be found in [Table 6](#).

Table 5 Wire Gauges and Tightening Torque

Terminal Signal	Screw Size	Tightening Torque (N·m)	Bare Cable		Wiring Gauges with Crimp Terminals		Wire Type
			Possible Gauges mm ² (AWG)	Recommended Gauges mm ² (AWG)	Possible Gauges mm ² (AWG)	Recommended Gauges mm ² (AWG)	
A+, A-, B+, B-, Z+, Z-, FE, IP, IG	M2	0.22 to 0.25	Stranded wire: 0.25 to 1.0 (24 to 17)	0.75 (18)	0.25 to 0.5 (24 to 20)	0.5 (20)	Shielded twisted pair, etc.
AO, IG, BO, IG, ZO, IG			Single line: 0.25 to 1.5 (24 to 16)				Shielded line, etc.

■ Crimp Terminals

Yaskawa recommends using CRIMPFOX ZA-3 by Phoenix Contact to crimp the terminal ends.

NOTICE: Wire ends should be properly trimmed so no wire extends out from the crimp terminals.

Table 6 Crimp Terminal Sizes

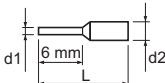
	Wire Gauge mm ² (AWG)	Model	L (mm)	d1 (mm)	d2 (mm)	Manufacturer
	0.25 (24)	AI 0.25 - 6YE	10.5	0.8	2	Phoenix Contact
	0.34 (22)	AI 0.34 - 6TQ	10.5	0.8	2	
	0.5 (20)	AI 0.5 - 6WH	14	1.1	2.5	

◆ Wiring Procedure

When wiring the option card, wire ends should be prepared as shown in **Figure 10**. See **Wire Gauges and Tightening Torque on page 18** to make sure that the proper tightening torque is applied to each terminal end.

Take particular precautions to ensure that each cable is properly connected, and that wire covering has not been accidentally inserted into the terminals.

NOTICE: *Insulation or tape may be required to ensure that shielded lines do not come into contact with other wiring. Insufficient insulation may cause a short circuit that can damage the option card and the drive.*

NOTICE: *Follow the tightening torque specifications in this manual for all terminal screws. Failing to do so may keep the drive from functioning properly and could damage the terminal block.*

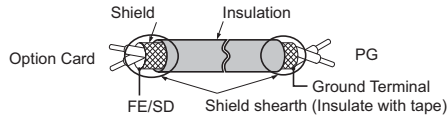

Figure 10 Treating Terminal Ends for Shielded Line

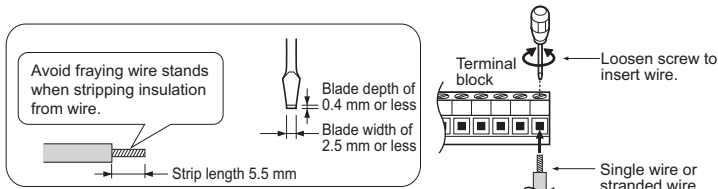

Figure 11 Terminal Block Wiring

5 Related Parameters

The following parameters are used to set up the drive for operation with a PG option card. Set parameters as needed. Instructions on how to set parameters can be found in the instruction manual for the drive the PG option card is connected to.

Table 7 Related Parameters

No.	Parameter	Connector		Description	Setting Range	Default
		CN5-B	CN5-C			
F1-01 </>	PG 1 Pulse Setting		○	Sets the pulses to be read from the pulse generator.	0 to 60000	600
F1-02	PG Feedback Loss (PGo) Operation Selection	○	○	Sets the stopping method when the PG becomes disconnected (PGo). 0: Ramp to stop (decelerates at time set to C1-02) 1: Coast to stop 2: Fast Stop (decelerates at the time set to C1-09) 3: Continue running	0 to 3	1
F1-03	PG Overspeed (oS) Operation Selection	○	○	Sets the stopping method when overspeed is detected. 0: Ramp to stop (decelerates at time set to C1-02) 1: Coast to stop 2: Fast Stop (decelerates at the time set to C1-09) 3: Continue running	0 to 3	1
F1-04	PG Deviation (dEv) Operation Selection	○	○	0: Ramp to stop (decelerates at time set to C1-02) 1: Coast to stop 2: Fast Stop (decelerates at the time set to C1-09) 3: Continue running	0 to 3	3
F1-05	PG 1 Rotation		○	0: Forward = A pulse leads 1: Forward = B pulse leads	0, 1	0
F1-06	PG 1 Ratio for PG Pulse Monitor		○	Sets the division ratio for the pulses output from the PG encoder. Set as a three digit number where x is the first digit, y is the second digit, and z the third: $\text{Ratio} = \frac{(1 + x)}{yz}$ When only the A pulse is read, this ratio is disabled and pulses are set as $\frac{1}{32}$ to 1.	1 to 132	1

5 Related Parameters

No.	Parameter	Connector		Description	Setting Range	Default
		CN5-B	CN5-C			
F1-08	PG Overspeed (oS) Level	<input type="radio"/>	<input type="radio"/>	Sets the level for detecting overspeed (oS). Set as a percentage of the maximum output frequency.	0 to 120	115
F1-09	Overspeed (oS) Detection Time	<input type="radio"/>	<input type="radio"/>	Sets the time required for the motor to exceed the the level set in F1-08 to trigger a fault.	0.0 to 2.0	<>
F1-10	Excessive Speed Deviation Detection (dEv) Level	<input type="radio"/>	<input type="radio"/>	Sets the degree of speed deviation to trigger a dEv fault. Set as a percentage of the maximum output frequency.	0 to 50	10
F1-11	Excessive Speed Deviation Detection (DEv) Time	<input type="radio"/>	<input type="radio"/>	Sets the time required a speed deviation situation to trigger a fault.	0.0 to 10.0	0.5
F1-12 <>	PG 1 Gear Teeth 1		<input type="radio"/>	Number of gear teeth between the PG and motor.	0 to 1000	0
F1-13 <>	PG 1 Gear Teeth 2		<input type="radio"/>	$\frac{\text{Pulses} \times 60}{\text{F1-01}} \times \frac{\text{F1-13 (load side)}}{\text{F1-12 (motor side)}}$ A gear ratio of 1 will be used if any of these parameters is set to 0.		
F1-14	PG Disconnect (PGo) Detection Time	<input type="radio"/>	<input type="radio"/>	Sets the time in seconds for PG disconnect to be detected.	0.0 to 10.0	2.0
F1-18	Reverse Rotation detection for PG 1 (dv3)		<input type="radio"/>	0: Disabled n: Number of times a dv3 situation must be detected to trigger a fault.	0 to 10	10
F1-19	Reverse Rotation detection for PG 1 (dv4)		<input type="radio"/>	0: Disabled n: Number of times a dv4 situation must be detected to trigger a fault.	0 to 5000	128
F1-21	PG 1 Option Card Function		<input type="radio"/>	0: A pulse detection 1: AB pulse detection	0, 1	0
F1-30	Motor 2 PG Card Connector	-	-	Selects the connector for the PG option card connected to motor 2. 0: CN5-C 1: CN5-B	0 to 1	1
F1-31 <>	PG 2 Pulse Setting	<input type="radio"/>		Sets the pulses to be read from the pulse generator.	0 to 60000	1024
F1-32	PG 2 Rotation	<input type="radio"/>		0: Forward = A pulse leads 1: Forward = B pulse leads	0, 1	0

5 Related Parameters

No.	Parameter	Connector		Description	Setting Range	Default
		CN5-B	CN5-C			
F1-33 <2>	PG 2 Gear Teeth 1	○		Number of gear teeth between the PG and motor..		
F1-34 <2>	PG 2 Gear Teeth 2	○		$\frac{\text{Pulses} \times 60}{\text{F1-31}} \times \frac{\text{F1-33 (load side)}}{\text{F1-34 (motor side)}}$ A gear ratio of 1 will be used if any of these parameters is set to 0.	0 to 1000	0
F1-35	PG 2 Division Ratio for Pulse Monitor	○		Sets the division ratio for the pulses output from the PG encoder. Set as a three digit number where x is the first digit, y is the second digit, and z the third: $\text{Ratio} = \frac{(1 + x)}{yz}$ When only the A pulse is read, this ratio is disabled and pulses are set as $\frac{1}{32}$ to 1.	1 to 132	1
F1-37	PG 2 Option Card Function	○		0: A pulse detection 1: AB pulse detection	0, 1	0

<1> The number of output pulses for the PG can be calculated as follows:

$$f_{PG}(\text{Hz}) = \frac{\text{Motor speed at maximum frequency output (min}^{-1}\text{)}}{60} \times \text{PG rating (p/rev)}$$

<2> Value changes according to the control mode selection in A1-02.

<3> Enabled only when using the V/f with PG control mode.

6 Troubleshooting

◆ Error Codes Displayed on the Drive Operator

The table below lists the various fault codes related to the option card and pulse generator. Further detail on various faults can be found in the instruction manual for the drive.







- Make sure the PG cable is properly connected.
- Check the cables between the PG and the option card.
- Make sure the option card is properly installed to the drive.

Table 8 Fault Display

Digital Operator Display		Fault Name
dEv	dEv	Speed Deviation (for Control Mode with PG)
		The deviation between the speed reference and speed feedback is greater than the setting in F1-10 for longer than the time set to F1-11.
Cause		Possible Solution
Load is too heavy.		Reduce the load.
Acceleration and deceleration times are set too short.		Increase the acceleration and deceleration times (C1-01 through C1-08).
The load is locked up.		Check the machine.
Parameters are not set appropriately.		Check the settings of parameters F1-10 and F1-11.
Motor brake engaged.		Ensure the motor brake releases properly.
Digital Operator Display		Fault Name
$dU1$	dv1	Z-phase Pulse Fall Detection
		The motor turned one full rotation without the Z pulse being detected.
Cause		Possible Solution
PG encoder is not connected, not wired properly, or is damaged.		<ul style="list-style-type: none"> • Make sure the PG encoder is properly connected and shielded line is properly grounded. • If the problem continues after cycling power, then replace either the PG option card or the PG encoder itself.
Digital Operator Display		Fault Name
$dU2$	dv2	Z-phase Noise Fault Detection
		The Z pulse is out of phase by more than 5 degrees for the number of times specified in parameter F1-17.
Cause		Possible Solution
Noise interference along the PG cable.		Separate the PG cable lines from the source of the noise (very possibly drive output wiring).
PG cable is not wired properly.		Rewire the PG encoder and make sure all lines including shielded line are properly connected.

6 Troubleshooting

PG option card or the PG encoder is damaged.		If the problem continues after cycling power, then replace either the PG option card or the PG encoder itself.
Digital Operator Display		Fault Name
d_{u3}	dv3	Inversion Detection The torque reference and acceleration are in opposite directions from one another (one is in reverse and the other is forward) while at the same time the speed reference and actual motor speed differ by over 30% for the number of pulses set to F1-18.
Cause		Possible Solution
The Z-pulse offset is not set properly to E5-11.		Set the value for $\Delta\theta$ to E5-11 as specified on the motor nameplate. Replacing the PG encoder or changing the application so that the motor rotates in reverse instead requires readjustment of the Z-pulse offset.
An external force on the load side has caused the motor to move.		<ul style="list-style-type: none"> Make sure the motor is rotating in the right direction. Look for any problems on the load side that might be causing the motor to rotate in the opposite direction.
Noise interference along the PG cable affecting the A or B pulse.		Rewire the PG encoder and make sure all lines including shielded line are properly connected.
PG encoder is disconnected, not wired properly, or the PG option card or PG itself is damaged.		
Rotational direction for the PG encoder set to F1-05 is the opposite of the order of the motor lines.		Make sure motor lines for each phase (U, V, W) are connected properly.
Digital Operator Display		Fault Name
d_{u4}	dv4	Inversion Prevention Detection Pulses indicate that the motor is rotating in the opposite direction of the speed reference. Set the number of pulses to trigger inverse detection to F1-19. Note: Disable inverse detection in applications where the motor may rotate in the opposite direction of the speed reference. Setting F1-19 to 0 disables this feature.
Cause		Possible Solution
The Z-pulse offset is not set properly to E5-11.		<ul style="list-style-type: none"> Set the value for $\Delta\theta$ to E5-11 as specified on the motor nameplate. If the problem continues after cycling power, then replace either the PG option card or the PG encoder itself. Replacing the PG encoder or changing the application so that the motor rotates in reverse instead requires readjustment of the Z-pulse offset.
Noise interference along the PG cable affecting the A or B pulse.		<ul style="list-style-type: none"> Make sure the motor is rotating in the right direction. Look for any problems on the load side that might be causing the motor to rotate in the opposite direction.
PG encoder is disconnected, not wired properly, or the PG option card or PG itself is damaged.		<ul style="list-style-type: none"> Rewire the PG encoder and make sure all lines including shielded line are properly connected. If the problem continues after cycling power, then replace either the PG option card or the PG encoder itself.

Digital Operator Display		Fault Name
	oFA00	Non-Compatible Option Card at CN5-A
Cause		Possible Solution
Non-compatible option card connected to port CN5-A.		Use only compatible option cards. See note <F>.
Digital Operator Display		Fault Name
	oFb00	Non-Compatible Option Card at CN5-B
Cause		Possible Solution
Non-compatible option card connected to port CN5-B.		Use only compatible option cards. See note <F>.
Digital Operator Display		Fault Name
	oFb01	Option Card Connection Error at CN5-B
Cause		Possible Solution
Option card at port CN5-B was changed during run.		Switch the power off and reconnect the option card.
Digital Operator Display		Fault Name
	oFC01	Option Card Connection Error at CN5-C
Cause		Possible Solution
Option card at port CN5-C was changed during run.		Switch the power off and reconnect the option card.
Digital Operator Display		Fault Name
	oPE06	Control Method Selection Error
Cause		Possible Solutions
A control mode has been selected that requires a PG option card to be installed, but no PG encoder is installed (A1-02 = 1, 3, or 7).		<ul style="list-style-type: none"> • Connect a PG option card. • Correct the value set to A1-02.
Digital Operator Display		Fault Name
	oS	Overspeed
Cause		Possible Solutions
Overshoot is occurring.		<ul style="list-style-type: none"> • Increase the settings for C5-01 (Speed Control Proportional Gain 1) and reduce C5-02 (Speed Control Integral Time 1). • If using a Closed Loop Vector mode enable Feed Forward Control and perform Inertia Auto-Tuning.
Incorrect speed feedback scaling if terminal RP is used as speed feedback input in V/f control		<ul style="list-style-type: none"> • Set H6-02 to value of the speed feedback signal frequency when the motor runs at the maximum speed. • Adjust the input signal using parameters H6-03 through H6-05.

6 Troubleshooting

Incorrect PG pulse number has been set	• Check and correct parameter F1-01.
Inappropriate parameter settings.	Check the setting for the overspeed detection level and the overspeed detection time (F1-08 and F1-09).
Digital Operator Display	Fault Name
 PGo	PG Disconnect Detected when no PG pulses received for a time longer than setting in F1-14.
Cause	Possible Solutions
PG cable is disconnected.	Reconnect the cable.
PG cable wiring is wrong.	Correct the wiring.
PG encoder does not have enough power.	Make sure the correct power supply is properly connected to the PG encoder.
Brake is holding the motor.	Ensure the brake releases properly

<1> Depending on the type of option card, only a certain number of cards may be connected at the same time. Refer to the table below. More details can be found in the option card section of the drive instruction manual.

Table 9 Option Card Installation

Option Card	Connector	Number of Cards Possible
SI-C3, SI-N3, SI-P3, SI-S3, AI-A3, DI-A3 <2>	CN5-A	1
PG-B3, PG-X3	CN5-B, C	2 <3>
DO-A3, AO-A3	CN5-A, B, C	1

<2> The AI-A3 and DI-A3 option can also be installed to option ports CN5-B and CN5-C, but are then used for monitoring purposes only. Input levels are then displayed in U1-17, U1-21 to U1-23. Here, the option cards cannot be used to set the frequency reference or replace the drive analog input with higher resolution inputs.

<3> If only one PG option card is connected to the drive, use the CN5-C connector. If two PG option cards are connected, use both CN5-B and CN5-C.

7 Specifications & Warranty Information

◆ Specifications

Table 10 Option Card Specifications

Option Card	PG-B3
Compatible Pulse Generators	Complementary, Open-collector Single track (A pulse), 2 track (A, B pulse) or 3 track (A, B, Z pulse) H level: 8 to 12 V L level: 2.0 V max.
PG Wiring Length	Complementary: 100 m max. Open-collector: 50 m max.
PG Power Supply	Output voltage: 12 V \pm 5% Max. Output Current: 200 mA
Compatible Control Modes	V/f with PG, Closed Loop Vector, Closed Loop Vector for PM motors
Maximum Input Frequency	50 kHz
Pulse Monitor Output	Monitor for A, B, and Z pulse output: 24 V max, 30 mA Open-collector output
PG Disconnect Detection	Software detection
Ambient Temperature	-10°C to 50°C
Humidity	95% RH or less with no condensation
Storage Temperature	-20°C to 60°C allowed for short-term transport of the product
Area of Use	Indoor (free of corrosive gas, airborne particles, etc.)
Altitude	1000 m or less

7 Specifications & Warranty Information

◆ Revision History

The revision dates and numbers of the revised manuals are given on the bottom of the back cover.

MANUAL NO. TOBP C730600 36A

Published in Japan July 2008 08-7

└─ Date of publication └─ Date of original publication

Date of Publication	Rev. No	Section	Revised Content
July 2008	—	—	First edition

YASKAWA AC Drive-Option Card Complementary Type PG Installation Manual

IRUMA BUSINESS CENTER (SOLUTION CENTER)

480, Kamifuji-sawa, Iruma, Saitama 358-8555, Japan
Phone 81-4-2962-5696 Fax 81-4-2962-6138

YASKAWA ELECTRIC AMERICA, INC.

2121 Norman Drive South, Waukegan, IL 60085, U.S.A.
Phone 1-847-887-7000 Fax 1-847-887-7370

YASKAWA ELÉTRICO DO BRASIL LTDA.

Avenida Fagundes Filho, 620 São Paulo-SP CEP 04304-000, Brazil
Phone 55-11-3585-1100 Fax 55-11-5581-8795

YASKAWA ELECTRIC EUROPE GmbH

Hauptstraße 185, 65760 Eschborn, Germany
Phone 49-6196-569-300 Fax 49-6196-569-398

YASKAWA ELECTRIC UK LTD.

1 Hunt Hill Orchardton Woods Cumbernauld, G68 9LF, United Kingdom
Phone 44-1236-735000 Fax 44-1236-458182

YASKAWA ELECTRIC KOREA CORPORATION

7F, Doore Bldg. 24, Yeoido-dong, Youngdungpo-Ku, Seoul 150-877, Korea
Phone 82-2-784-7844 Fax 82-2-784-8495

YASKAWA ELECTRIC (SINGAPORE) PTE. LTD.

151 Lorong Chuan, #04-01, New Tech Park 556741, Singapore
Phone 65-6282-3003 Fax 65-6289-3003

YASKAWA ELECTRIC (SHANGHAI) CO., LTD.

No.18 Xizang Zhong Road, Room 1702-1707, Harbour Ring Plaza Shanghai 200001, China
Phone 86-21-5385-2200 Fax 86-21-5385-3299

YASKAWA ELECTRIC (SHANGHAI) CO., LTD. BEIJING OFFICE

Room 1011A, Tower W3 Oriental Plaza, No.1 East Chang An Ave.,
Dong Cheng District, Beijing 100738, China
Phone 86-10-8518-4086 Fax 86-10-8518-4082

YASKAWA ELECTRIC TAIWAN CORPORATION

9F, 16, Nanking E. Rd., Sec. 3, Taipei, Taiwan
Phone 886-2-2502-5003 Fax 886-2-2505-1280



YASKAWA

YASKAWA ELECTRIC CORPORATION

In the event that the end user of this product is to be the military and said product is to be employed in any weapons systems or the manufacture thereof, the export will fall under the relevant regulations as stipulated in the Foreign Exchange and Foreign Trade Regulations. Therefore, be sure to follow all procedures and submit all relevant documentation according to any and all rules, regulations and laws that may apply. Specifications are subject to change without notice for ongoing product modifications and improvements.

© 2008 YASKAWA ELECTRIC CORPORATION. All rights reserved.

MANUAL NO. TOBP C730600 36A

Published in Japan July 2008 08-7
08-5-3