

8902/EQ

HTTL Speed Feedback Option

HA469255U001 Issue 4
Technical Manual

aerospace
climate control
electromechanical
filtration
fluid & gas handling
hydraulics
pneumatics
process control
sealing & shielding



ENGINEERING **YOUR** SUCCESS.



8902/EQ HTTL Speed Feedback Option

Technical Manual
HA469255U001 Issue 4

Compatible with Version 1.x Software

© Copyright 2011 Parker SSD Drives, a division of Parker Hannifin Ltd.

All rights strictly reserved. No part of this document may be stored in a retrieval system, or transmitted in any form or by any means to persons not employed by a Parker SSD Drives company without written permission from Parker SSD Drives, a division of Parker Hannifin Ltd. Although every effort has been taken to ensure the accuracy of this document it may be necessary, without notice, to make amendments or correct omissions. Parker SSD Drives cannot accept responsibility for damage, injury, or expenses resulting therefrom.

WARRANTY

Parker SSD Drives warrants the goods against defects in design, materials and workmanship for the period of 12 months from the date of delivery on the terms detailed in Parker SSD Drives Standard Conditions of Sale IA500504.

Parker SSD Drives reserves the right to change the content and product specification without notice.

Safety Information



WARNING!

During commissioning, remove the fuses (or trip the circuit breaker) on your 3-phase supply.
Make sure the power is OFF, and that it cannot be switched on accidentally whilst you are working.

REFER TO YOUR MAIN PRODUCT MANUAL FOR SPECIFIC SAFETY INFORMATION ABOUT THE DEVICE YOU ARE CONTROLLING

IMPORTANT: Please read this information BEFORE installing the equipment.

Intended Users

This manual is to be made available to all persons who are required to install, configure or service equipment described herein, or any other associated operation.

The information given is intended to highlight safety issues, EMC considerations, and to enable the user to obtain maximum benefit from the equipment.

Application Area

The equipment described is intended for industrial motor speed control.

Personnel

Installation, operation and maintenance of the equipment should be carried out by qualified personnel. A qualified person is someone who is technically competent and familiar with all safety information and established safety practices; with the installation process, operation and maintenance of this equipment; and with all the hazards involved.

Safety

All control and signal terminals are SELV, i.e. protected by double insulation.

EMC

In a domestic environment this product may cause radio interference in which case the user may be required to take adequate counter-measures.

This equipment contains electrostatic discharge (ESD) sensitive parts. Observe static control precautions when handling, installing and servicing this product.

Safety Information



CAUTION!

At any time, there may be a loss of motor control and separate/independent application measures should be taken to ensure that such loss of motor control cannot present a safety hazard.

RISK ASSESSMENT

Under fault conditions, power loss or unintended operating conditions, the drive may not operate as intended. In particular:

- Stored energy might not discharge to safe levels as quickly as suggested, and can still be present even though the drive appears to be switched off
- The motor's direction of rotation might not be controlled
- The motor speed might not be controlled
- The motor might be energised

A drive is a component within a drive system that may influence its operation or effects under a fault condition. Consideration must be given to:

- Stored energy
- Supply disconnects
- Sequencing logic
- Unintended operation

Contents

Contents

Page

HTTL SPEED FEEDBACK OPTION	1
Description	1
• Features	1
• Part Number	1
• Used On	1
• Specifications.....	1
Recommended Spare Parts	1
DIP Switch Settings	2
Installation	3
Fitting the Option	3
Wiring the System	5
• X34 Connections	5
Initial Set-up	6
Configuring the 890 Drive.....	6
• ENCODER Function Block	6
Parker SSD Drives Approved Encoders	8

HTTL SPEED FEEDBACK OPTION

Description

The HTTL Speed Feedback Option allows incremental encoders to be connected directly to the motor controller to provide highly accurate speed feedback measurement.

Features

The option has the following features:

- Contains three optically isolated differential inputs on channels A, B and M
- Decoding logic to interface the encoder to the microprocessor
- Supplies variable voltage, isolated encoder power supply

Part Number

The part number for the HTTL Speed Feedback Option is:

8902-EQ-00-00

8902-EQ-00-FF (indicates a factory-fitted option)

Used On

This option can be used on 890 drives with the following Product Codes:

890SD-.. 890SD Standalone Drive

890CD-.. 890CD Common Bus Drive

Refer to the 890 Engineering Reference Manual, Appendix E for Product Code details.

Specifications

Maximum Pulse Rate	250kHz (differential) 200kHz (single-ended)
Receiver Current	≤10mA per channel
Input Format	Two differential channels in quadrature, clock/dir or clock only
Input Voltage Range	±30V (differential) 0-30V (single-ended)
Input Voltage Threshold	3V ± 1V (differential) 8V ± 1V (single-ended)
Encoder Supply	Maximum load = 200mA or 2W, whichever is smaller. Voltage adjustable 10-20V by firmware
Terminal Wire Size (maximum)	16 AWG
Terminal Tightening Torque	0.22 - 0.25Nm (1.9 - 2.2 pound-inches)

Recommended Spare Parts

We recommend that you keep one option as a spare to reduce down-time.

DIP Switch Settings

The switch settings control the following inputs:

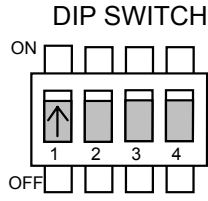

Input Threshold				
Switch Number	1	2	3	4
Input Controlled	A	B	M	not used
3V±1	On	On	On	On
8V±1	Off	Off	Off	Off

Usually the switches will be set to give a threshold of 3V when using a differential encoder, and to 8V when using a single-ended encoder. (Factory default is with all switches set in the ON position - 3V).

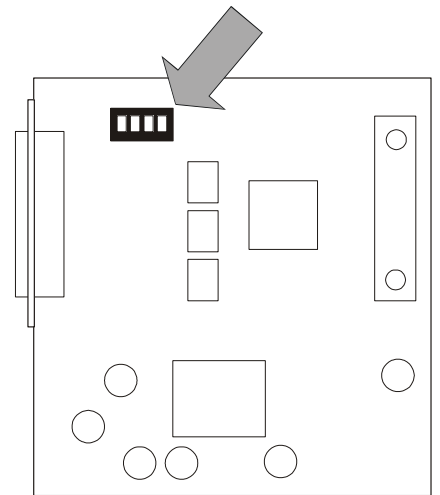

Figure 1 Option board showing DIP Switch location

Installation

Fitting the Option

If the option is not factory-fitted, follow the procedure given below.

WARNING!

Disconnect all sources of power before attempting installation.

Caution

This option contains ESD (Electrostatic Discharge) sensitive parts. Observe static control precautions when handling, installing and servicing this option.

The Control Card assembly needs to be removed from the drive as follows to fit the Option in "OPTION F" position.

1. Undo the two screws securing Option A and Option B to the front of the drive. If options are not fitted, completely remove the blank covers for the Option A and Option B slots.
 2. Undo the captive screws (A) located in the top and bottom handles of the control board. Gently pull on the handles to withdraw the board from the drive, supporting any attached option boards. Note that the boards are sliding in top and bottom slots.
 3. If fitted, remove Option A and/or B boards that are mounted on the control board by separating the connector at the rear of the option board from the control board.
 4. Remove the blanking plate from "OPTION F" location (2 screws).
 5. Remove the terminal block from the HTTL Option.
 6. Offer up the HTTL Option through the "OPTION F" cut-out as shown opposite. Fit the two locating pegs of the large connector on the rear edge of the option board into the locating holes on the control board, as shown opposite.
 7. Fit the two screws and crinkle washers (C) at the rear edge of the Option.
DO NOT OVERTIGHTEN.
Tightening torque : 0.2Nm (28 oz-in).
- Ensure locating pegs are correctly located visibly through locating holes.

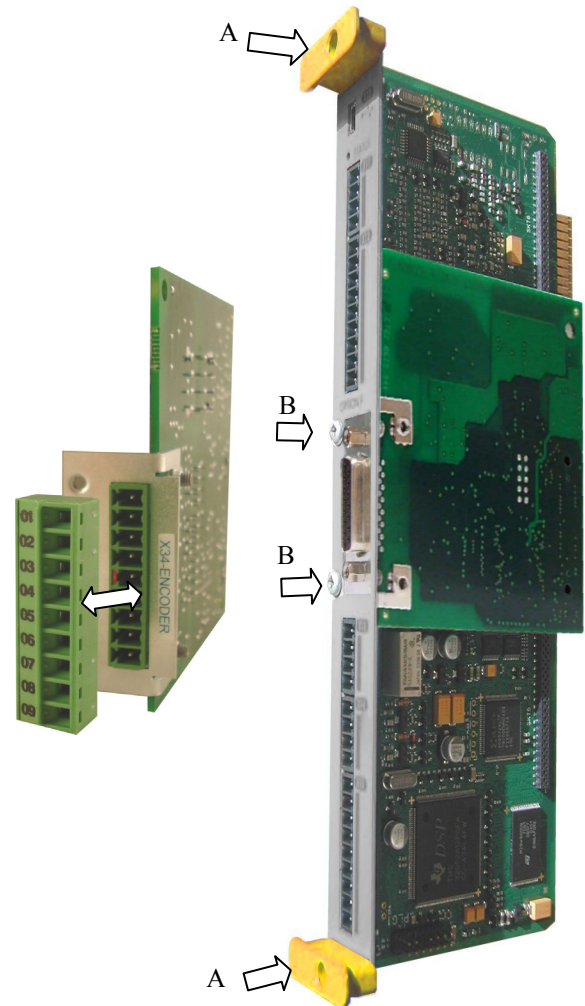

Figure 2 Control board showing Option correctly mounted

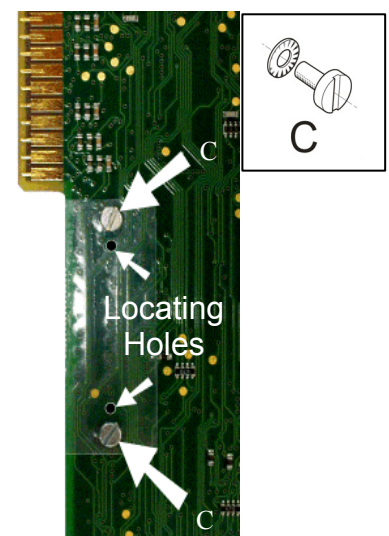

Figure 3 Rear of Control Board

8. Secure with the two screws (B) to the front of the control board.

Ensure 'C' screws to option connector have been fully tightened before fitting 'B' screws. The front panel screws (B) are self-tapping and can be quite hard to turn. This turning torque must not be transferred through the option board to the control board connector. To avoid this hold the option board with one hand, while tightening the front panel screws with the other. DO NOT hold the control board while tightening these screws.

9. Re-fit terminal block to the HTTL Option.
10. Refit Options A and B: Press the assembly into the connector on the Control Board. Ensure that the front panel of the TechCard overlaps the front of the Control Board. Ease the connector at the TechCard so that the two PCB's are parallel when viewed on edge.
11. Replace the control board (with attached options) into the drive. Tighten screws (A).
12. Tighten the Option A and Option B screws; or importantly, fit the blank covers and secure with the screws. If Options are not fitted.

Wiring the System

WARNING!
Disconnect all sources of power before attempting installation.

Caution
This option contains ESD (Electrostatic Discharge) sensitive parts. Observe static control precautions when handling, installing and servicing this option.

X34 Connections

For correct operation, A, /A, B and /B **must** be connected as shown. If any is left unconnected, the HTTL speed feedback option will not operate.

The M input is not normally connected - it is for use with future versions of the drive software.

M: for connection to the once-per-revolution marker output from the encoder to verify correct operation of the encoder.

Take special care wiring the encoders to the Option due to the low level of the signals.

Use twisted-pair, screened cable, preferably with an overall screen and a screen over each individual pair. To ensure compliance with the EMC Directive the overall cable screen should be connected to the encoder body and to the cable clamp.

Recommended cable:

3 pairs individually screened, plus overall screen, characteristic impedance 100 to 120Ω, e.g. Belden 8163

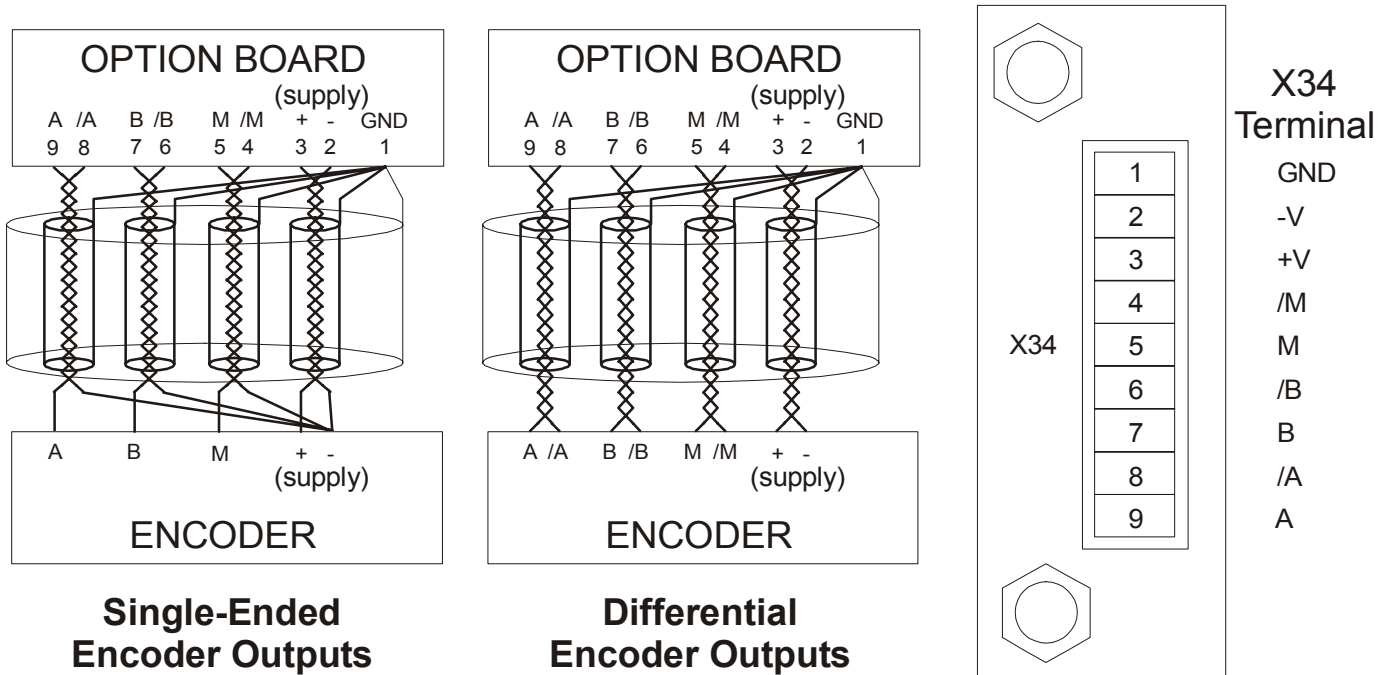

Figure 4 Wiring Diagram

Initial Set-up

Configuring the 890 Drive

Use the DSE 890 Configuration Tool to configure the ENCODER function block, as detailed below.

Note: The DSE 890 Configuration Tool is Parker SSD Drives' Windows-based block programming software and is supplied with each drive.

ENCODER Function Block

SETUP::MOTOR CONTROL::ENCODER

This block allows Speed Feedback to be measured using a quadrature pulse encoder.

Parameter Descriptions

Parameter	PREF	Default	Range
PULSE ENC VOLTS	71.01	10.0 V	10.0 to 20.0 V
Set this approximately to the supply voltage required by the pulse encoder.			
SINCOS ENC VOLTS	71.22	5.0 V	See below
Set the supply volts required by the sin/cos encoder.			
<i>Enumerated Value : SinCos Encoder Volts</i>			
0 : 5V			
1 : 10V			
ENCODER LINES	71.02	2048	250 to 262143
Set the number of lines to match the type of encoder being used. Incorrect setting of this parameter will result in an erroneous speed measurement.			
ENCODER INVERT	71.03	FALSE	FALSE/TRUE
Used to match the encoder direction to the motor direction. When TRUE, changes the sign of the measured speed and the direction of the position count. Setting the encoder direction should be done as part of the Autotune when running in Closed-loop Vector Mode.			
LOAD G'BOX RATIO	71.05	1	1 to 64
This parameter can be used to configure absolute position control applications. It must be an integer gear box ratio, e.g. 64:1. If there is a gearbox between the motor and the load, set the gearbox ratio via this parameter. "LOAD POSITION" i.e. the position of the load on the other side of the gearbox, will then be calculated.			
ENCODER MECH O/S	71.06	0.0000 deg	0.0000 to 360.0000 deg
(encoder mechanical offset)			
Use this parameter to enter a mechanical offset of between 0 and 360 degrees to allow the output shaft position to be correctly zeroed. This value is subtracted from the LOAD POSITION which is reported by the encoder.			
To zero the shaft position: turn the shaft to the zero position; note the value of the LOAD POSITION parameter, and enter this value into the ENCODER MECH O/S parameter. LOAD POSITION will now read zero.			
Note that "load position" refers here to the shaft position on the other side of a gearbox which may be mounted on the motor output. It does not refer to the motor shaft position, unless the output gearbox ratio (LOAD G'BOX RATIO) is set to 1 (i.e. no gearbox fitted).			
ENCODER FBK %	71.08	— .xx %	— .xx %
This parameter shows the mechanical speed of the motor shaft, calculated from the encoder feedback, as a percentage of the user maximum speed setting (MAX SPEED in the REFERENCE function block).			
SHAFT POSITION	71.09	— .xx deg	— .xx deg
This diagnostic provides the motor shaft position (before the gear box).			

Ignore the setting for this parameter



Parameter Descriptions

LOAD POSITION *PREF: 71.10* *Default: —.xx deg* *Range: —.xx deg*

This is the position of a shaft on the other side of a gearbox attached to the motor. If a gearbox is not fitted, set LOAD G'BOX RATIO to 1. This variable is controlled by the position loop, i.e. the position loop will force the load position to equal the demanded position.

ENCODER TYPE *PREF: 71.04* *Default: 0* *Range: See below*

This parameter defines the type of encoder being used.

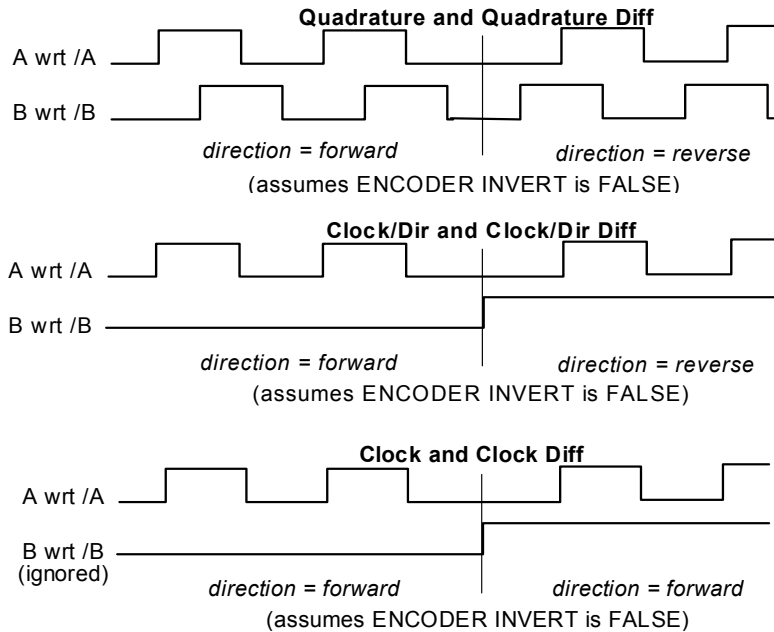

Enumerated Value : Type

➔ 0 : QUADRATURE	single-ended pulse encoder
➔ 1 : CLOCK/DIR	single-ended pulse encoder
➔ 2 : CLOCK	single-ended pulse encoder
➔ 3 : QUADRATURE DIFF	differential pulse encoder
➔ 4 : CLOCK/DIR DIFF	differential pulse encoder
➔ 5 : CLOCK DIFF	differential pulse encoder
6 : SIN COS INC	sin/cos encoder
7 : ABS ENDAT ST	single turn endat absolute encoder
8 : ABS ENDAT MT	multi-turn endat absolute encoder

Save the Application

Remember to save your new configuration in DSE 890 and install it in the drive. In DSE 890, select "Command→Install At Selected" to install the currently opened configuration into a drive.

8

Parker SSD Drives Approved Encoders

Recommended Encoder (12mm bore)	Hengstler:	RI 58TD//2048ED.37IF
	SSD Drives Part Number:	DD464475U012
Recommended Encoder (North America) (Hollow Shaft, Various Bores)	BEI(HS35 series):	924-01070-279, -283, -281
	SSD Drives Part Number: Frame Designs: TENV, TEBC, TEFC	DD470666, DD470667, DD471123
Alternative Encoders (20mm bore)	Hengstler:	RI 76TD/2048ED-4N20IF
	SSD Drives Part Number:	DD464475U020

Encoders are available from Hengstler or BEI in other accuracies such as 500 lines/rev or 2000 lines/rev to suit the application.

**CANADA**

Parker Hannifin Canada
Motion & Control Division
160 Chisholm Drive
Milton, Ontario L9T 3G9
Tel: +1(905) 693-3000
Fax: +1(905) 876-1958

CHINA

Parker Hannifin Motion & Control
(Shanghai) Co. Ltd.,
280 Yungqiao Road
Jinqiao Export Processing Zone,
Pudong District, Shanghai 201206
Tel: +86(21) 5031 2525
Fax: +86(21) 5854 7599

FRANCE

Parker SSD Parvex
8 Avenue du Lac
B.P. 249
21007 Dijon Cedex
Tel: +33(0)3 80 42 41 40
Fax: +33(0)3 80 42 41 23

GERMANY

Parker Hannifin GmbH
Von-Humboldt-Strasse 10
64646 Heppenheim
Tel: +49 (6252) 798200
Fax: +49(6252) 798205

ITALY

Parker Hannifin SPA
Via C. Gounod, Cinisello Balsamo
1-20092, Milano
Tel: +39(0236) 1081
Fax: +39(0236) 108400

USA

Parker Hannifin Corporation
SSD Drives
9225 Forsyth Park Drive
Charlotte
North Carolina 28273
Tel: +1(704)588 3246
Fax: +1(704)588 3249

Local availability and service support also in:

05/03/09

Argentina • Australia • Austria • Bangladesh • Belgium • Brazil • Chile • Columbia • Costa Rica • Cyprus • Czech Republic
• Denmark • Ecuador • Egypt • Finland • Greece • Hong Kong • Hungary • India • Indonesia • Iran • Ireland • Israel •
Japan • Jordan • Kenya • Korea • Kuwait • Lithuania • Malaysia • Netherlands • New Zealand • Nigeria • Norway • Peru
• Philippines • Poland • Portugal • Qatar • Romania • Russia • Saudi Arabia • Singapore • Slovenia • Slovakia • South
Africa • Spain • Sri Lanka • Sweden • Switzerland • Taiwan • Turkey • United Arab Emirates • Vietnam • Zimbabwe



Parker Hannifin Ltd., Automation Group, SSD Drives Europe
New Courtwick Lane, Littlehampton, West Sussex BN17 7RZ
United Kingdom. Tel: +44(0)1903 737000 Fax: +44(0)903 737100
www.SSDdrives.com