

ACS850

Firmware Manual
ACS850 Standard Control Program



ACS850 drive manuals

DRIVE HARDWARE MANUAL*

ACS850-04 Drive Modules (1.1 to 45 kW) Hardware Manual – 3AUA0000045496 (English)

ACS850-04 Drive Modules (55 to 160 kW, 75 to 200 hp) Hardware Manual – 3AUA0000045487 (English)

ACS850-04 Drive Modules (200 to 500 kW, 250 to 600 hp) Hardware Manual – 3AUA0000026234 (English)

DRIVE FIRMWARE MANUALS

ACS850 Standard Control Program Firmware Manual** – 3AUA0000045497 (English).

OPTION MANUALS*

FIO-01 Digital I/O Extension User's Manual – 3AFE68784921 (English)

FIO-11 Analog I/O Extension User's Manual – 3AFE68784930 (English)

FIO-21 Analog I/O Extension User's Manual – 3AUA0000031061 (English)

FEN-01 TTL Encoder Interface User's Manual – 3AFE68784603 (English)

FEN-11 Absolute Encoder Interface User's Manual – 3AFE68784841 (English)

FEN-21 Resolver Interface User's Manual – 3AFE68784859 (English)

FEN-31 HTL Encoder Interface User's Manual – 3AUA0000031044 (English)

*The delivery includes a multilingual quick installation guide.

**The delivery includes a multilingual quick start-up guide.

Firmware Manual

ACS850 Standard Control Program

Table of contents



Table of contents

ACS850 drive manuals	2
----------------------------	---

1. About the manual

What this chapter contains	11
Compatibility	11
Safety instructions	11
Reader	11
Contents	12
Related manuals	12

2. The ACS850 control panel

What this chapter contains	13
Features	13
Installation	14
Mechanical installation	14
Electrical installation	14
Layout	15
Status line	16
Operating instructions	17
Basics of operation	17
List of tasks	18
Help and panel version – Any mode	19
Basic operations – Any mode	20
Output mode	21
Parameters	23
Assistants	30
Changed Parameters	32
Fault Logger	34
Time & Date	36
Parameter Backup	38
I/O Settings	46
Reference Edit	48
Drive Info	49
Parameter Change Log	50

3. Control locations and operating modes

What this chapter contains	53
Local control vs. external control	54
Local control	54
External control	55
Operating modes of the drive	55
Speed control mode	55
Torque control mode	55
Special control modes	55



4. Program features

What this chapter contains	57
Application macros	58
Automatic fault resets	58
Autophasing	58
Constant speeds	59
Critical speeds	59
DC voltage control	59
Overvoltage control	59
Undervoltage control	60
Voltage control and trip limits	60
Brake chopper	61
Drive-to-drive link	61
Emergency stop	62
Encoder support	62
Energy optimizer	62
Fieldbus control	63
Jogging	63
Load analyzer	64
Peak value logger	64
Amplitude loggers	64
Maintenance counters	65
Mechanical brake control	66
Process PID control	70
Sleep function for process PID control	70
Programmable analog inputs	71
Programmable analog outputs	72
Programmable digital inputs and outputs	72
Programmable relay outputs	72
Programmable protection functions	72
Start interlock (parameter 10.20)	72
External fault (parameter 30.01)	73
Local control loss detection (parameter 30.03)	73
Motor phase loss detection (parameter 30.04)	73
Earth fault detection (parameter 30.05)	73
Supply phase loss detection (parameter 30.06)	73
Safe Torque Off detection (parameter 30.07)	73
Switched supply and motor cabling (parameter 30.08)	73
Stall protection (parameters 30.09...30.12)	73
Scalar motor control	74
IR compensation for a scalar controlled drive	74
Signal supervision	74
Speed controller tuning	74
Thermal motor protection	76
Thermal motor protection model	76
Temperature measurement	76
Settings	77
Timers	77
User-definable load curve	79
User-definable U/f curve	79



5. Application macros

What this chapter contains	81
General	81
Factory macro	82
Default control connections for the Factory macro	83
Hand/Auto macro	84
Default control connections for the Hand/Auto macro	85
PID control macro	86
Default control connections for the PID control macro	87
Torque control macro	88
Default control connections for the Torque control macro	89
Sequential control macro	90
Default control connections for the Sequential control macro	92

6. Parameters

What this chapter contains	93
Terms and abbreviations	93
Parameter listing	94
01 Actual values	94
02 I/O values	95
03 Control values	101
04 Appl values	102
06 Drive status	103
08 Alarms & faults	106
09 System info	108
10 Start/stop	109
11 Start/stop mode	116
12 Operating mode	118
13 Analogue inputs	119
14 Digital I/O	126
15 Analogue outputs	139
16 System	145
19 Speed calculation	147
20 Limits	150
21 Speed ref	152
22 Speed ref ramp	155
23 Speed ctrl	158
24 Torque ref	166
25 Critical speed	167
26 Constant speeds	168
27 Process PID	170
30 Fault functions	174
31 Mot therm prot	177
32 Automatic reset	182
33 Supervision	183
34 User load curve	186
35 Process variable	188
36 Timed functions	194
38 Flux ref	199



8 Table of contents

40 Motor control	200
42 Mech brake ctrl	201
44 Maintenance	205
45 Energy optimising	211
47 Voltage ctrl	212
48 Brake chopper	212
49 Data storage	213
50 Fieldbus	214
51 FBA settings	216
52 FBA data in	217
53 FBA data out	217
56 Panel display	217
57 D2D communication	218
64 Load analyzer	220
90 Enc module sel	224
91 Absol enc conf	225
92 Resolver conf	228
93 Pulse enc conf	228
94 Ext IO conf	229
95 Hw configuration	229
97 User motor par	230
99 Start-up data	231

7. Additional parameter data

What this chapter contains	237
Terms and abbreviations	237
Fieldbus addresses	238
Pointer parameter format in fieldbus communication	238
32-bit integer value pointers	238
32-bit integer bit pointers	239
Parameter groups 1...9	240
Parameter groups 10...99	243

8. Fault tracing

What this chapter contains	259
Safety	259
Alarm and fault indications	259
How to reset	260
Fault history	260
Alarm messages generated by the drive	260
Fault messages generated by the drive	268

9. Fieldbus control

What this chapter contains	277
System overview	278
Setting up communication through a fieldbus adapter module	279
Drive control parameters	281
The fieldbus control interface	282

The Control Word and the Status Word	283
Actual values	283
FBA communication profile	283
Fieldbus references	284
State diagram	285

10. Control block diagrams

What this chapter contains	287
Speed feedback	288
Speed reference modification and ramping	289
Speed error handling	290
Torque reference modification, operating mode selection	291
Process PID	292
Direct torque control	293

Further information

Product and service inquiries	295
Product training	295
Providing feedback on ABB Drives manuals	295
Document library on the Internet	295







About the manual

What this chapter contains

The chapter describes the contents of the manual. It also contains information on the compatibility, safety and intended audience.

Compatibility

The manual is compatible with ACS850 standard control program.

Safety instructions

Follow all safety instructions delivered with the drive.

- Read the **complete safety instructions** before you install, commission, or use the drive. The complete safety instructions are given at the beginning of the *Hardware Manual*.
- Read the **software function specific warnings and notes** before changing the default settings of the function. For each function, the warnings and notes are given in this manual in the section describing the related user-adjustable parameters.

Reader

The reader of the manual is expected to know the standard electrical wiring practices, electronic components, and electrical schematic symbols.

Contents

The manual consists of the following chapters:

- *The ACS850 control panel* provides a description and instructions for use of the control panel.
- *Control locations and operating modes* describes the control locations and operation modes of the drive.
- *Program features* contains descriptions of the features of the ACS850 standard control program.
- *Application macros* contains a short description of each macro together with a connection diagram.
- *Parameters* describes the parameters of the drive.
- *Additional parameter data* contains further information on the parameters.
- *Fault tracing* lists the alarm (warning) and fault messages with possible causes and remedies.
- *Fieldbus control* describes the communication to and from a fieldbus network.
- *Control block diagrams* contains a graphical representation of the control program.

Related manuals

The delivery of the drive includes a multilingual *Quick Start-up Guide*.

A complete list of related manuals is printed on the inside of the front cover.



The ACS850 control panel

What this chapter contains

This chapter describes the features and operation of the ACS850 control panel.

The control panel can be used to control the drive, read status data, and adjust parameters.

Features

- alphanumeric control panel with an LCD display
 - copy function – parameters can be copied to the control panel memory for later transfer to other drives or for backup of a particular system.
 - context sensitive help
 - real time clock.
-

Installation

■ Mechanical installation

For mounting options, see the *Hardware Manual* of the drive.

Instructions for mounting the control panel onto a cabinet door are available in *ACS-CP-U Control Panel IP54 Mounting Platform Kit Installation Guide* (3AUA0000049072 [English]).

■ Electrical installation

Use a CAT5 straight-through network cable with a maximum length of 3 meters. Suitable cables are available from ABB.

For the control panel connector location on the drive, see the *Hardware Manual* of the drive.

Layout

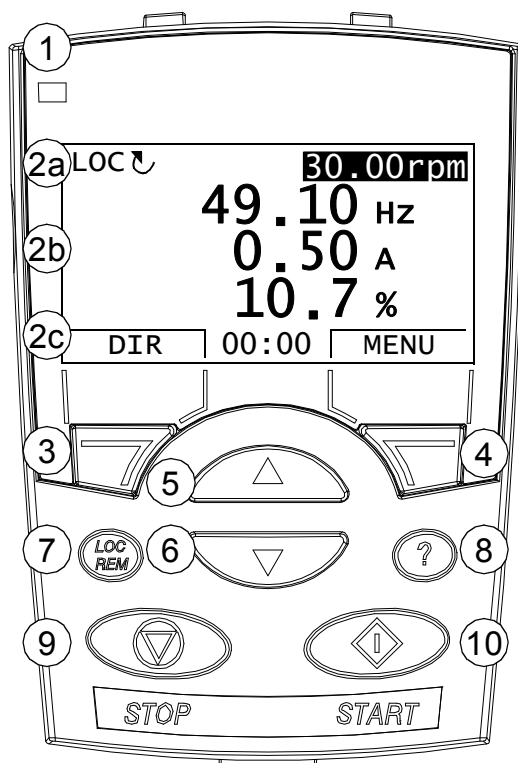

No.	Use
1	Status LED – Green for normal operation.
2	LCD display – Divided into three main areas: Status line – variable, depending on the mode of operation, see section Status line on page 16. Center – variable; in general, shows signal and parameter values, menus or lists. Shows also faults and alarms. Bottom line – shows current functions of the two soft keys and, if enabled, the clock display.
3	Soft key 1 – Function depends on the context. The text in the lower left corner of the LCD display indicates the function.
4	Soft key 2 – Function depends on the context. The text in the lower right corner of the LCD display indicates the function.
5	Up – Scrolls up through a menu or list displayed in the center of the LCD display. Increments a value if a parameter is selected. Increments the reference value if the upper right corner is highlighted. Holding the key down changes the value faster.
6	Down – Scrolls down through a menu or list displayed in the center of the LCD display. Decrements a value if a parameter is selected. Decrements the reference value if the upper right corner is highlighted. Holding the key down changes the value faster.
7	LOC/REM – Changes between local and remote control of the drive.
8	Help – Displays context sensitive information when the key is pressed. The information displayed describes the item currently highlighted in the center of the display.
9	STOP – Stops the drive in local control.
10	START – Starts the drive in local control.

■ Status line

The top line of the LCD display shows the basic status information of the drive.

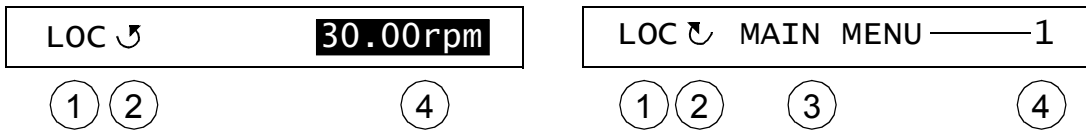



No.	Field	Alternatives	Significance
1	Control location	LOC	Drive control is local, that is, from the control panel.
		REM	Drive control is remote, such as the drive I/O or fieldbus.
2	State	↻	Forward shaft direction
		↺	Reverse shaft direction
		Rotating arrow	Drive is running at reference.
		Dotted rotating arrow	Drive is running but not at reference.
		Stationary arrow	Drive is stopped.
		Dotted stationary arrow	Start command is present, but the motor is not running, e.g. because start enable signal is missing.
3	Panel operation mode		<ul style="list-style-type: none"> • Name of the current mode • Name of the list or menu shown • Name of the operation state, e.g. REF EDIT.
4	Reference value or number of the selected item		<ul style="list-style-type: none"> • Reference value in the Output mode • Number of the highlighted item, e.g mode, parameter group or fault.

Operating instructions

■ Basics of operation

You operate the control panel with menus and keys. The keys include two context-sensitive soft keys, whose current function is indicated by the text shown in the display above each key.

You select an option, e.g. operation mode or parameter, by entering the MENU state using soft key 2, and then by scrolling the  and  arrow keys until the option is highlighted and then pressing the relevant soft key. With the right soft key you usually enter a mode, accept an option or save the changes. The left soft key is used to cancel the made changes and return to the previous operation level.

The Control Panel has ten options in the Main menu: Parameters, Assistants, Changed Par, Fault Logger, Time & Date, Parameter Backup, I/O Settings, Reference Edit, Drive Info and Parameter Change Log. In addition, the control panel has an Output mode, which is used as default. Also, when a fault or alarm occurs, the panel goes automatically to the Fault mode showing the fault or alarm. You can reset the fault in the Output or Fault mode. The operation in these modes and options is described in this chapter.

Initially, the panel is in the Output mode, where you can start, stop, change the direction, switch between local and remote control, modify the reference value and monitor up to three actual values. To do other tasks, go first to the Main menu and select the appropriate option on the menu. The status line (see section [Status line](#) on page 11) shows the name of the current menu, mode, item or state.

LOC ↵	30.00rpm
	49.10 Hz
	0.50 A
	10.7 %
DIR	00:00 MENU

LOC ↵	MAIN MENU	1
PARAMETERS		
ASSISTANTS		
CHANGED PAR		
EXIT	00:00	ENTER

■ List of tasks





The table below lists common tasks, the mode in which you can perform them, abbreviations of the options in the Main menu and the page number where the steps to do the task are described in detail.

Task	Mode / Main menu option	Abbreviations of the Main menu options *	Page
How to get help	Any	-	19
How to find out the panel version	Any	-	19
How to start and stop the drive	Output	-	20
How to switch between local and remote control	Any	-	20
How to change the direction of the motor rotation	Any	-	21
How to set the speed, frequency, torque or position reference in the Output mode	Output	-	21
How to adjust the display contrast	Output	-	22
How to change the value of a parameter	Parameters	PARAMETERS	23
How to change the value of value pointer parameters	Parameters	PARAMETERS	24
How to change the value of bit pointer parameter to point to the value of a bit in another signal	Parameters	PARAMETERS	26
How to change the value of bit pointer parameter to fixed 0 (FALSE) or 1 (TRUE)	Parameters	PARAMETERS	28
How to select the monitored signals	Parameters	PARAMETERS	29
How to do guided tasks (specification of related parameter sets) with assistants	Assistants	ASSISTANTS	30
How to view and edit changed parameters	Changed Parameters	CHANGED PAR	32
How to view faults	Fault Logger	FAULT LOGGER	34
How to reset faults and alarms	Fault Logger	FAULT LOGGER	35
How to show/hide the clock, change date and time formats, set the clock and enable/disable automatic clock transitions according to the daylight saving changes	Time & Date	TIME & DATE	36
How to copy parameters from the drive to the control panel	Parameter Backup	PAR BACKUP	38
How to restore parameters from the control panel to the drive	Parameter Backup	PAR BACKUP	38
How to view backup information	Parameter Backup	PAR BACKUP	44
How to edit and change parameter settings related to I/O terminals	I/O Settings	I/O SETTINGS	46
How to edit reference value	Reference Edit	REF EDIT	48
How to view drive info	Drive Info	DRIVE INFO	49
How to view and edit recently changed parameters	Parameter Change Log	PAR CHG LOG	50



* Main menu options actually shown in the control panel.

■ Help and panel version – Any mode

How to get help

Step	Action	Display
1.	<p>Press  to read the context-sensitive help text for the item that is highlighted.</p> <p>If help text exists for the item, it is shown on the display.</p>	<pre> LOC ↵ TIME & DATE — 6 TIME FORMAT DATE FORMAT SET TIME SET DATE DAYLIGHT SAVING EXIT 00:00 SEL </pre> <pre> LOC ↵ HELP — Use daylight saving to enable or disable automatic clock adjustment according to daylight saving EXIT 00:00 </pre>
2.	<p>If the whole text is not visible, scroll the lines with keys  and .</p>	<pre> LOC ↵ HELP — to enable or disable automatic clock adjustment according to daylight saving changes EXIT 00:00 </pre>
3.	<p>After reading the text, return to the previous display by pressing .</p>	<pre> LOC ↵ TIME & DATE — 6 TIME FORMAT DATE FORMAT SET TIME SET DATE DAYLIGHT SAVING EXIT 00:00 SEL </pre>









How to find out the panel version

Step	Action	Display
1.	<p>If the power is switched on, switch it off.</p> <ul style="list-style-type: none"> - If the panel cable can be disconnected easily, unplug the panel cable from the control panel, OR - if the panel cable can not be disconnected easily, switch off the control board or the drive. 	
2.	<p>Keep key  depressed while you switch on the power and read the information. The display shows the following panel information:</p> <p>Panel SW: Panel firmware version ROM CRC: Panel ROM check sum Flash Rev: Flash content version Flash content comment.</p> <p>When you release the  key, the panel goes to the Output mode.</p>	<pre> PANEL VERSION INFO Panel SW: x.xx ROM CRC: xxxxxxxxxx Flash Rev: x.xx XXXXXXXXXXXXXXXXXXXX XXXXXXXXXXXXXXXXXXXX </pre>

■ Basic operations – Any mode

How to start, stop and switch between local and remote control

You can start, stop and switch between local and remote control in any mode. To be able to start or stop the drive by using the control panel, the drive must be in local control.

Step	Action	Display
1.	<p>To switch between remote control (REM shown on the status line) and local control (LOC shown on the status line), press .</p> <p>Note: Switching to local control can be prevented with parameter 16.01 Local lock.</p> <p>The very first time the drive is powered up, it is in remote control (REM) and controlled through the drive I/O terminals. To switch to local control (LOC) and control the drive using the control panel, press . The result depends on how long you press the key: If you release the key immediately (the display flashes “Switching to the local control mode”), the drive stops. Set the local control reference as instructed on page 21. If you press the key until the text “Keep running” appears, the drive continues running as before. The drive copies the current remote values for the run/stop status and the reference, and uses them as the initial local control settings.</p> <p>To stop the drive in local control, press .</p> <p>To start the drive in local control, press .</p>	<div style="border: 1px solid black; padding: 5px; margin-bottom: 10px;"> <p>LOC  MESSAGE</p> <p>Switching to the local control mode.</p> <hr/> <p style="text-align: center;">00:00</p> </div> <p>The arrow ( or ) on the status line stops rotating.</p> <p>The arrow ( or ) on the status line starts rotating. It is dotted until the drive reaches the setpoint.</p>

■ Output mode

In the Output mode, you can:



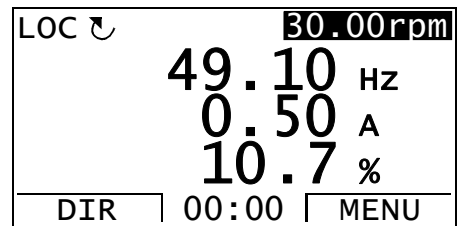

- monitor actual values of up to three signals
- change the direction of the motor rotation
- set the speed, frequency, torque or position reference
- adjust the display contrast
- start, stop, change the direction and switch between local and remote control.

You get to the Output mode by pressing  repeatedly.

The top right corner of the display shows the reference value. The center can be configured to show up to three signal values or bar graphs; see page 29 for instructions on selecting and modifying the monitored signals.

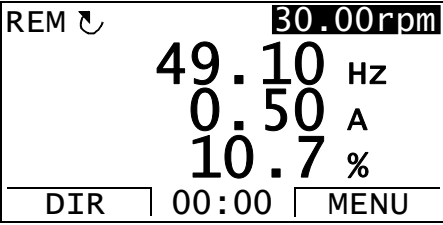

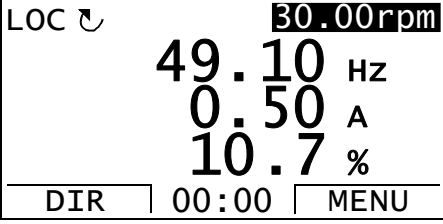
How to change the direction of the motor rotation



Step	Action	Display
1.	If you are not in the Output mode, press  repeatedly until you get there.	
2.	If the drive is in remote control (REM shown on the status line), switch to local control by pressing  . The display briefly shows a message about changing the mode and then returns to the Output mode.	
3.	To change the direction from forward (↶ shown on the status line) to reverse (↷ shown on the status line), or vice versa, press  .	

How to set the speed, frequency, torque or position reference in the Output mode

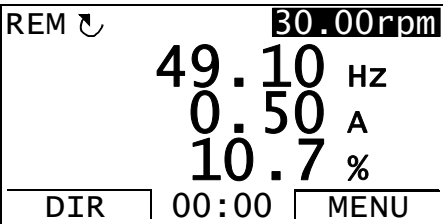

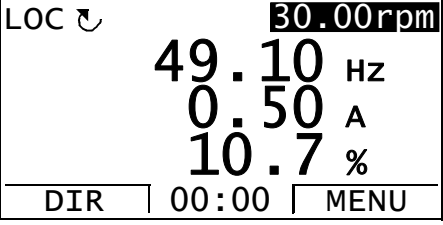

See also section [Reference Edit](#) on page 48.

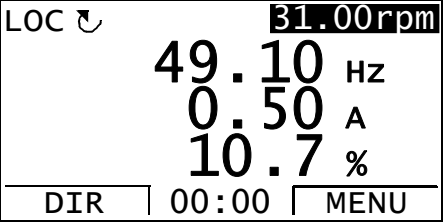
Step	Action	Display
1.	If you are not in the Output mode, press  repeatedly until you get there.	

22 The ACS850 control panel

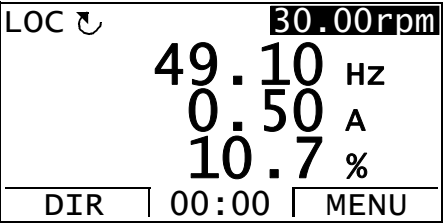
Step	Action	Display
2.	If the drive is in remote control (REM shown on the status line), switch to local control by pressing  . The display briefly shows a message about changing the mode and then returns to the Output mode.	
3.	To increase the highlighted reference value shown in the top right corner of the display, press  . The value changes immediately. It is stored in the permanent memory of the drive and restored automatically after power switch-off. To decrease the value, press  .	

How to adjust the display contrast

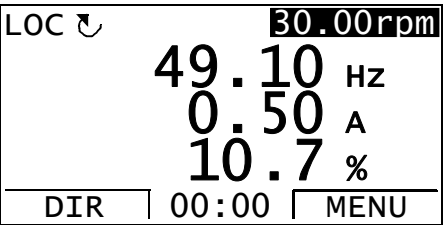









Step	Action	Display
1.	If you are not in the Output mode, press  repeatedly until you get there.	
2.	To increase the contrast, press keys  and  simultaneously. To decrease the contrast, press keys  and  simultaneously.	





■ Parameters

In the Parameters option, you can:

- view and change parameter values
- start, stop, change the direction and switch between local and remote control.







How to select a parameter and change its value













Step	Action	Display
1.	Go to the Main menu by pressing  if you are in the Output mode. Otherwise press  repeatedly until you get to the Main menu.	<pre> LOC ↵ MAIN MENU — 1 PARAMETERS ASSISTANTS CHANGED PAR EXIT 00:00 ENTER </pre>
2.	Go to the Parameters option by selecting PARAMETERS on the menu with keys  and  , and pressing  .	<pre> LOC ↵ PAR GROUPS — 01 01 Actual values 02 I/O values 03 Control values 04 Appl values 06 Drive status EXIT 00:00 SEL </pre>
3.	Select the appropriate parameter group with keys  and  .	<pre> LOC ↵ PAR GROUPS — 99 99 Start-up data 01 Actual values 02 I/O values 03 Control values 04 Appl values EXIT 00:00 SEL </pre>
	Press  .	<pre> LOC ↵ PARAMETERS — 9901 Language English 9904 Motor type 9905 Motor ctrl mode 9906 Mot nom current EXIT 00:00 EDIT </pre>
4.	Select the appropriate parameter with keys  and  . The current value of the parameter is shown below the selected parameter. Here the parameter 99.06 <i>Mot nom current</i> is used as an example.	<pre> LOC ↵ PARAMETERS — 9901 Language 9904 Motor type 9905 Motor ctrl mode 9906 Mot nom current 0.0 A EXIT 00:00 EDIT </pre>
	Press  .	<pre> LOC ↵ PAR EDIT — 9906 Mot nom current 0.0 A CANCEL 00:00 SAVE </pre>

Step	Action	Display
5.	Specify a new value for the parameter with keys  and  . Pressing an arrow key once increments or decrements the value. Keeping the key depressed for a while first quickly changes the current digit until the cursor moves left one position. This is repeated until the key is released. After the key is released, step-by-step adjustment of the current digit is possible. If neither key is pressed for a while, the cursor returns to the right one position at a time. Pressing both keys simultaneously replaces the displayed value with the default value.	<pre> LOC ↶ PAR EDIT 9906 Mot nom current 3.5 A ----- CANCEL 00:00 SAVE </pre>
6.	To save the new value, press  . To cancel the new value and keep the original, press  .	<pre> LOC ↶ PARAMETERS 9906 Mot nom current 3.5 A 9907 Mot nom voltage 9908 Mot nom freq 9909 Mot nom speed ----- EXIT 00:00 EDIT </pre>

How to change the value of value pointer parameters











In addition to the parameters shown above, there are two kinds of pointer parameters; value pointer parameters and bit pointer parameters. A value pointer parameter points to the value of another parameter.









Step	Action	Display
1.	Go to the Main menu by pressing  if you are in the Output mode. Otherwise press  repeatedly until you get to the Main menu.	<pre> LOC ↶ MAIN MENU ——— 1 PARAMETERS ASSISTANTS CHANGED PAR ----- EXIT 00:00 ENTER </pre>
2.	Go to the Parameters option by selecting PARAMETERS on the menu with keys  and  , and pressing  .	<pre> LOC ↶ PAR GROUPS ——— 01 01 Actual values 02 I/O values 03 Control values 04 Appl values 06 Drive status ----- EXIT 00:00 SEL </pre>
3.	Select the appropriate parameter group with keys  and  . Here the value pointer parameter 21.01 Speed ref1 sel is used as an example.	<pre> LOC ↶ PAR GROUPS ——— 21 15 Analogue outputs 16 System 19 Signal conditions 20 Limits 21 Speed ref ----- EXIT 00:00 SEL </pre>

Step	Action	Display
4.	Press  to select the appropriate parameter group. Select the appropriate parameter with keys  and  , current value of each parameter is shown below it.	<pre> LOC ↵ PARAMETERS 2101 Speed ref1 sel AI2 scaled 2102 Speed ref2 sel 2103 Speed ref1 func 2104 Speed ref1/2 sel EXIT 00:00 EDIT </pre>
5.	Press  . Current value of the value pointer parameter is shown, as well as the parameter it points to.	<pre> LOC ↵ PAR EDIT 2101 Speed ref1 sel AI1 scaled [P.02.05] CANCEL 00:00 SEL </pre>
6.	Specify a new value with keys  and  . The parameter the value pointer parameter points to changes respectively.	<pre> LOC ↵ PAR EDIT 2101 Speed ref1 sel FBA ref1 [P.02.26] CANCEL 00:00 SEL </pre>
7.	Press  to accept any of the preselected values and to return to the parameters list. The new value is shown in the parameters list. To freely define an analog signal as the value, choose Pointer and press  . The parameter group and index will be shown. Select the parameter group with  and  . The text below the cursor displays the currently-selected parameter group.	<pre> LOC ↵ PARAMETERS 2101 Speed ref1 sel FBA ref1 2102 Speed ref2 sel 2103 Speed ref1 func 2104 Speed ref1/2 sel EXIT 00:00 EDIT </pre> <pre> LOC ↵ PAR EDIT 2101 Speed ref1 sel P.02.05 02 I/O values CANCEL 00:00 SAVE </pre>
8.	Press  to select the parameter index. Again, the text below the cursor reflects the current setting.	<pre> LOC ↵ PAR EDIT 2101 Speed ref1 sel P.02.07 0207 AI2 scaled CANCEL 00:00 SAVE </pre>
9.	To save the new value for the pointer parameter, press  . The new value is shown in the parameters list.	<pre> LOC ↵ PARAMETERS 2101 Speed ref1 sel AI2 scaled 2102 Speed ref2 sel 2103 Speed ref1 func 2104 Speed ref1/2 sel EXIT 00:00 EDIT </pre>

How to change the value of bit pointer parameters

The bit pointer parameter points to the value of a bit in another signal, or can be fixed to 0 (FALSE) or 1 (TRUE). For the latter option, see page 28. A bit pointer parameter points to a bit value (0 or 1) of one bit in a 32-bit signal. The first bit from the left is bit number 31, and the first bit from the right is bit number 0.













Step	Action	Display
1.	Go to the Main menu by pressing  if you are in the Output mode. Otherwise press  repeatedly until you get to the Main menu.	<pre> LOC ↺ MAIN MENU ——— 1 PARAMETERS ASSISTANTS CHANGED PAR EXIT 00:00 ENTER </pre>
2.	Go to the Parameters option by selecting PARAMETERS on the menu with keys  and  , and pressing  .	<pre> LOC ↺ PAR GROUPS ——— 01 01 Actual values 02 I/O values 03 Control values 04 Appl values 06 Drive status EXIT 00:00 SEL </pre>
3.	Select the appropriate parameter group with keys  and  . Here the bit pointer parameter 10.02 Ext1 start in1 is used as an example.	<pre> LOC ↺ PAR GROUPS ——— 10 10 Start/stop/dir 11 Start/stop mode 12 Operating mode 13 Analogue inputs 14 Digital I/O EXIT 00:00 SEL </pre>
4.	Press  to select the appropriate parameter group. Current value of each parameter is shown below its name. Select the parameter 10.02 Ext1 start in1 with keys  and  .	<pre> LOC ↺ PARAMETERS ——— 1001 Ext1 start func In1 1002 Ext1 start in1 1003 Ext1 start in2 1004 Ext2 start func EXIT 00:00 EDIT </pre> <pre> LOC ↺ PARAMETERS ——— 1001 Ext1 start func 1002 Ext1 start in1 DI1 1003 Ext1 start in2 1004 Ext2 start func EXIT 00:00 EDIT </pre>
5.	Press  .	<pre> LOC ↺ PAR EDIT ——— 1002 Ext1 start in1 DI1 [P.02.01.00] CANCEL 00:00 SEL </pre>





Step	Action	Display
6.	Specify a new value with keys  and  . The text below the cursor shows the corresponding parameter group, index and bit.	<pre> LOC ↵ PAR EDIT 1002 Ext1 start in1 DI6 [P.02.01.05] CANCEL 00:00 SEL </pre>
7.	<p>Press  to accept any of the preselected values and to return to the parameters list.</p> <p>To freely define a bit of a binary parameter as the value, choose Pointer and press . The parameter group, index and bit will be shown.</p> <p>Select the parameter group with  and . The text below the cursor displays the currently-selected parameter group.</p>	<pre> LOC ↵ PARAMETERS 1002 Ext1 start in1 DI6 1003 Ext1 start in2 1004 Ext2 start func 1005 Ext2 start in1 EXIT 00:00 EDIT </pre> <pre> LOC ↵ PAR EDIT 1002 Ext1 start in1 P.02.01.00 02 I/O values CANCEL 00:00 SAVE </pre>
8.	Press  to select the parameter index. Again, the text below the cursor reflects the current setting.	<pre> LOC ↵ PAR EDIT 1002 Ext1 start in1 P.02.01.00 0201 DI status CANCEL 00:00 SAVE </pre>
9.	Press  to select the bit. Again, the text below the cursor reflects the current setting.	<pre> LOC ↵ PAR EDIT 1002 Ext1 start in1 P.02.01.01 01 DI2 CANCEL 00:00 SAVE </pre>
10.	To save the new value for the pointer parameter, press  . The new value is shown in the parameters list.	<pre> LOC ↵ PARAMETERS 1002 Ext1 start in1 P.02.01.01 1003 Ext1 start in2 1004 Ext2 start func 1005 Ext2 start in1 EXIT 00:00 EDIT </pre>

How to change the value of bit pointer parameter to fixed 0 (FALSE) or 1 (TRUE)

The bit pointer parameter can be fixed to constant value of 0 (FALSE) or 1 (TRUE).

When adjusting a bit pointer parameter on the control panel, CONST is selected in order to fix the value to 0 (displayed as C.FALSE) or 1 (C.TRUE).

Step	Action	Display
1.	Go to the Main menu by pressing  if you are in the Output mode. Otherwise press  repeatedly until you get to the Main menu.	<pre> LOC ↵ MAIN MENU — 1 PARAMETERS ASSISTANTS CHANGED PAR EXIT 00:00 ENTER </pre>
2.	Go to the Parameters option by selecting PARAMETERS on the menu with keys  and  , and pressing  . Select the appropriate parameter group with keys  and  . Here the bit pointer parameter <i>14.07 DIO2 out src</i> is used as an example.	<pre> LOC ↵ PAR GROUPS — 01 01 Actual values 02 I/O values 03 Control values 04 Appl values 06 Drive status EXIT 00:00 SEL </pre> <pre> LOC ↵ PAR GROUPS — 14 10 Start/stop/dir 11 Start/stop mode 12 Operating mode 13 Analogue inputs 14 Digital I/O EXIT 00:00 SEL </pre>
3.	Press  to select the appropriate parameter group. Select the appropriate parameter with keys  and  . Current value of each parameter is shown below its name.	<pre> LOC ↵ PARAMETERS — 1401 DIO1 Ton 1405 DIO1 Toff 1406 DIO2 conf 1407 DIO2 out src P.06.02.03 EXIT 00:00 EDIT </pre>
4.	Press  . Select CONST with keys  and  .	<pre> LOC ↵ PAR EDIT — 1407 DIO2 out src Pointer CANCEL 00:00 NEXT </pre> <pre> LOC ↵ PAR EDIT — 1407 DIO2 out src Const CANCEL 00:00 NEXT </pre>

Step	Action	Display
5.	Press  .	<pre> LOC ↻ PAR EDIT 1407 DIO2 out src C.FALSE [0] CANCEL 00:00 SAVE </pre>
6.	Specify a new constant value (TRUE or FALSE) for the bit pointer parameter with keys  and  .	<pre> LOC ↻ PAR EDIT 1407 DIO2 out src C.TRUE [1] CANCEL 00:00 SAVE </pre>
7.	To continue, press  . To cancel the new value and keep the original, press  . The new value is shown in the parameters list.	<pre> LOC ↻ PARAMETERS 1407 DIO2 out src C.TRUE 1408 DIO2 Ton 1409 DIO2 Toff 1410 DIO3 conf EXIT 00:00 EDIT </pre>

How to select the monitored signals

Step	Action	Display
1.	You can select which signals are monitored in the Output mode and how they are displayed with group 56 Panel display parameters. See page 23 for detailed instructions on changing parameter values. Note: If you set one of the parameters 56.01...56.03 to zero, in the output mode you can see names for the two remaining signals. The names are also shown if you set one of the mode parameters 56.04...56.06 to <i>Disabled</i> .	<pre> LOC ↻ PAR EDIT 5601 signal1 param 01.03 CANCEL 00:00 NEXT </pre> <pre> LOC ↻ PAR EDIT 5602 signal2 param 01.04 CANCEL 00:00 NEXT </pre> <pre> LOC ↻ PAR EDIT 5603 signal3 param 01.06 CANCEL 00:00 NEXT </pre>

■ Assistants













Assistants are routines that guide you through the essential parameter settings related to a specific task, for example application macro selection, entering the motor data, or reference selection.



In the Assistants mode, you can:

- use assistants to guide you through the specification of a set of basic parameters
- start, stop, change the direction and switch between local and remote control.

How to use an assistant

The table below shows how assistants are invoked. The Motor Set-up Assistant is used here as an example.

Step	Action	Display
1.	Go to the Main menu by pressing  if you are in the Output mode. Otherwise press  repeatedly until you get to the Main menu.	<pre> LOC ↻ MAIN MENU ——— 1 PARAMETERS ASSISTANTS CHANGED PAR EXIT 00:00 ENTER </pre>
2.	Go to the Assistants mode by selecting ASSISTANTS on the menu with keys  and  , and pressing  .	<pre> LOC ↻ ASSISTANTS ——— 1 Firmware assistants Application assistant EXIT 00:00 SEL </pre>
3.	The Motor Set-up assistant under Firmware assistants is used as an example. Select Firmware assistants with keys  and  , and press  .	<pre> LOC ↻ CHOICE ——— Select assistant Application Macro Motor Set-up EXIT 00:00 OK </pre>
4.	Select Motor Set-up with keys  and  , and press  .	<pre> LOC ↻ PAR EDIT ——— 9904 Motor type AM [0] EXIT 00:00 SAVE </pre>
5.	Select the appropriate motor type with keys  and  .	<pre> LOC ↻ PAR EDIT ——— 9904 Motor type PMSM [1] EXIT 00:00 SAVE </pre>













Step	Action	Display
6.	<p>To accept the new value and continue to the setting of the next parameter, press .</p> <p>After all the parameters of the assistant are set, the Assistants menu is displayed. You can then select another assistant or exit the Assistants mode.</p> <p>To abort an assistant, press  at any point.</p>	<div style="border: 1px solid black; padding: 5px;"> <p>LOC ↻ PAR EDIT</p> <p>9905 Motor ctrl mode</p> <p style="text-align: center;">DTC</p> <p>[0]</p> <hr/> <p>EXIT 00:00 SAVE</p> </div>

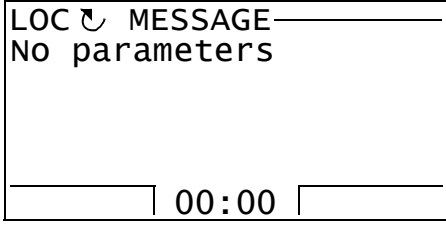
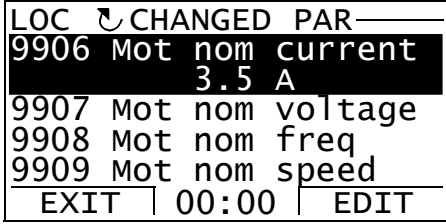

■ Changed Parameters

In the Changed Parameters mode, you can:

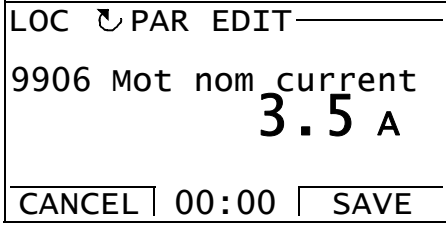
- view a list of all parameters that have been changed from the macro default values
- change these parameters
- start, stop, change the direction and switch between local and remote control.

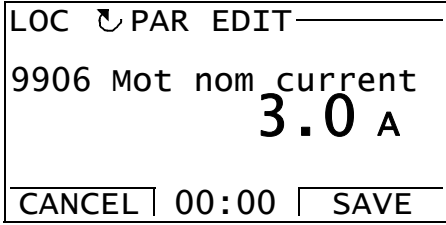
How to view and edit changed parameters

Step	Action	Display
1.	Go to the Main menu by pressing  if you are in the Output mode. Otherwise press  repeatedly until you get to the Main menu.	
2.	Go to the Changed Parameters mode by selecting CHANGED PAR on the menu with keys  and  , and pressing  . If there are no changed parameters in the history, corresponding text will be shown. If parameters have been changed, a list of them is shown. Select the changed parameter on the list with keys  and  . The value of the selected parameter is shown below it.	 
3.	Press  to modify the value.	
4.	Specify a new value for the parameter with keys  and  . Pressing the key once increments or decrements the value. Holding the key down changes the value faster. Pressing the keys simultaneously replaces the displayed value with the default value.	













Step	Action	Display
5.	<p>To accept the new value, press . If the new value is the default value, the parameter is removed from the list of changed parameters.</p> <p>To cancel the new value and keep the original, press .</p>	<pre> LOC ↶ CHANGED PAR 9906 Mot nom current 3.0 A 9907 Mot nom voltage 9908 Mot nom freq 9909 Mot nom speed EXIT 00:00 EDIT </pre>







■ Fault Logger

In the Fault Logger option, you can:

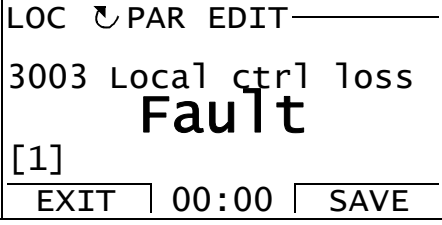

- view the drive fault history
- see the details of the most recent faults
- read the help text for the fault and make corrective actions
- start, stop, change the direction and switch between local and remote control.

How to view faults

Step	Action	Display
1.	Go to the Main menu by pressing  if you are in the Output mode. Otherwise press  repeatedly until you get to the Main menu.	<pre> LOC ↻ MAIN MENU ——— 1 PARAMETERS ASSISTANTS CHANGED PAR EXIT 00:00 ENTER </pre>
2.	Go to the Fault Logger option by selecting FAULT LOGGER on the menu with keys  and  , and pressing  . If there are no faults in the fault history, corresponding text will be shown. If there is a fault history, the display shows the fault log starting with the most recent fault. The number on the row is the fault code according to which the causes and corrective actions are listed in chapter Fault tracing (page 259).	<pre> LOC ↻ MESSAGE ——— No fault history found LOC ↻ FAULT LOGGER — 1. 36: LOCAL CTRL LOSS 29.04.08 10:45:58 EXIT 00:00 DETAIL </pre>
3.	To see the details of a fault, select it with keys  and  , and press  . Scroll the text with keys  and  . To return to the previous display, press  .	<pre> LOC ↻ LOCAL CTRL LOSS TIME 10:45:58 FAULT CODE 36 FAULT CODE EXTENSION EXIT 00:00 DIAG </pre>
4.	If you want help in diagnosing the fault, press  .	<pre> LOC ↻ ——— Check parameter '30.0 3 Local ctrl loss' se tting. Check PC tool or panel connection. EXIT OK </pre>

Step	Action	Display
5.	Press  . The panel allows you to edit necessary parameters to correct the fault.	
6.	Specify a new value for the parameter with keys  and  . To accept the new value, press  . To cancel the new value and keep the original, press  .	

How to reset faults

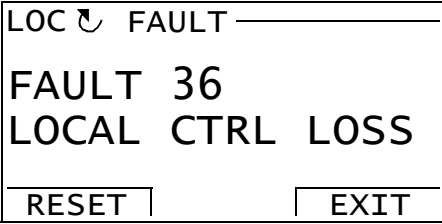
Step	Action	Display
1.	When a fault occurs, a text identifying the fault is shown. To reset the fault, press  . To return to the previous display, press  .	

















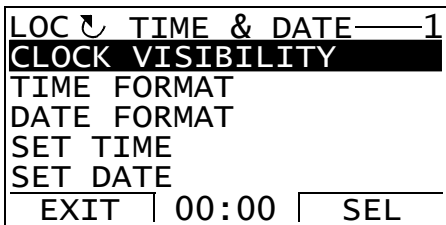

■ Time & Date



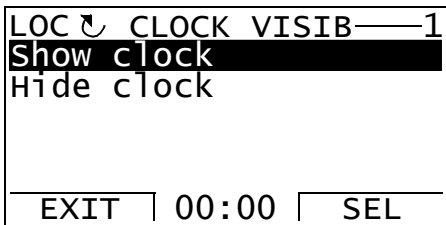





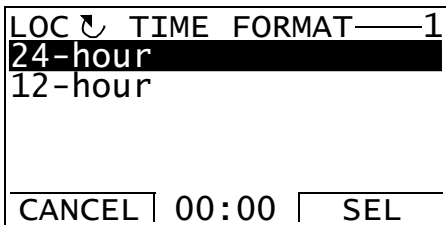



















In the Time & Date option, you can:

- show or hide the clock
- change date and time display formats
- set the date and time
- enable or disable automatic clock transitions according to the daylight saving changes
- start, stop, change the direction and switch between local and remote control.

The Control Panel contains a battery to ensure the function of the clock when the panel is not powered by the drive.

How to show or hide the clock, change display formats, set the date and time and enable or disable clock transitions due to daylight saving changes

Step	Action	Display
1.	Go to the Main menu by pressing  if you are in the Output mode. Otherwise press  repeatedly until you get to the Main menu.	
2.	Go to the Time & Date option by selecting TIME & DATE on the menu with keys  and  , and pressing  .	
3.	To show (hide) the clock, select CLOCK VISIBILITY on the menu, press  , select Show clock (Hide clock) with keys  and  and press  , or, if you want to return to the previous display without making changes, press  .	
	To specify the time format, select TIME FORMAT on the menu, press  and select a suitable format with keys  and  . Press  to save or  to cancel your changes.	

Step	Action	Display
	<p>To specify the date format, select DATE FORMAT on the menu, press  and select a suitable format. Press  to save or  to cancel your changes.</p> <p>To set the time, select SET TIME on the menu and press . Specify the hours with keys  and , and press . Then specify the minutes. Press  to save or  to cancel your changes.</p>	<p>LOC  DATE FORMAT—1 dd.mm.yy mm/dd/yy dd.mm.yyyy mm/dd/yyyy</p> <p>CANCEL 00:00 OK</p> <hr/> <p>LOC  SET TIME— 15:41</p> <p>CANCEL OK</p>
	<p>To set the date, select SET DATE on the menu and press . Specify the first part of the date (day or month depending on the selected date format) with keys  and , and press . Repeat for the second part. After specifying the year, press . To cancel your changes, press .</p>	<p>LOC  SET DATE— 19.03.2008</p> <p>CANCEL 00:00 OK</p>
	<p>To enable or disable the automatic clock transitions according to the daylight saving changes, select DAYLIGHT SAVING on the menu and press . Pressing  opens the help that shows the beginning and end dates of the period during which daylight saving time is used in each country or area whose daylight saving changes you can select to be followed. Scroll the text with keys  and . To return to the previous display, press .</p> <p>To disable automatic clock transitions according to the daylight saving changes, select Off and press .</p> <p>To enable automatic clock transitions, select the country or area whose daylight saving changes are followed and press .</p> <p>To return to the previous display without making changes, press .</p>	<p>LOC  DAYLIGHT SAV—1 Off EU US Australia1:NSW,Vict.. Australia2:Tasmania.. EXIT 00:00 SEL</p> <hr/> <p>LOC  HELP— EU: On: Mar last Sunday Off: Oct last Sunday</p> <p>US: EXIT 00:00 </p>

■ Parameter Backup

The Parameter Backup option is used to export parameters from one drive to another or to make a backup of the drive parameters. Uploading stores all drive parameters, including up to four user sets, to the Control Panel. Selectable subsets of the backup file can then be restored/downloaded from the control panel to the same drive or another drive of the same type.

In the Parameter Backup option, you can:



- Copy all parameters from the drive to the control panel with MAKE BACKUP TO PANEL. This includes all defined user sets of parameters and internal (not adjustable by the user) parameters such as those created by the ID Run.
- View the information about the backup stored in the control panel with SHOW BACKUP INFO. This includes e.g. version information etc. of the current backup file in the panel. It is useful to check this information when you are going to restore the parameters to another drive with RESTORE PARS ALL to ensure that the drives are compatible.
- Restore the full parameter set from the control panel to the drive using the RESTORE PARS ALL command. This writes all parameters, including the internal non-user-adjustable motor parameters, to the drive. It does NOT include the user sets of parameters.















Note: Use this function only to restore the parameters from a backup or to restore parameters to systems that are compatible.

- Restore all parameters, except motor data, to the drive with RESTORE PARS NO-IDRUN.
- Restore only motor data parameters to the drive with RESTORE PARS IDRUN.
- Restore all user sets to the drive with RESTORE ALL USER SETS.
- Restore only user set 1...4 to the drive with RESTORE USER SET 1...RESTORE USER SET 4.

How to backup and restore parameters

For all backup and restore functions available, see page [38](#).



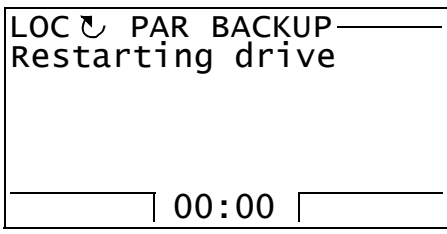
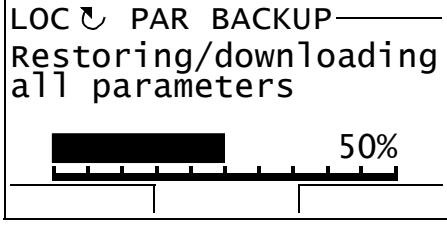
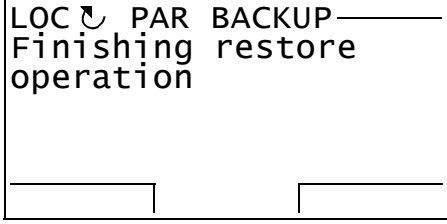

Step	Action	Display
1.	Go to the Main menu by pressing  if you are in the Output mode. Otherwise press  repeatedly until you get to the Main menu.	



Step	Action	Display
2.	<p>Go to the Parameter Backup option by selecting PAR BACKUP on the menu with keys  and , and pressing .</p>	<pre> LOC ↻ PAR BACKUP——1 MAKE BACKUP TO PANEL SHOW BACKUP INFO RESTORE PARS ALL RESTORE PARS NO-IDRUN RESTORE PARS IDRUN EXIT 00:00 SEL </pre>
	<p>To copy all parameters (including user sets and internal parameters) from the drive to the control panel, select MAKE BACKUP TO PANEL on the Par Backup with keys  and , and press . Operation starts. Press  if you want to stop the operation.</p> <p>After the backup is completed, the display shows a message about the completion. Press  to return to the Par Backup.</p>	<pre> LOC ↻ PAR BACKUP—— Copying file 1/2 ABORT 00:00 LOC ↻ MESSAGE—— Parameter upload successful OK 00:00 </pre>
	<p>To perform restore functions, select the appropriate operation (here RESTORE PARS ALL is used as an example) on the Par Backup with keys  and .</p> <p>Press . Restoring starts.</p> <p>Backup interface version is checked. Scroll the text with keys  and .</p> <p>If you want to continue, press . Press  if you want to stop the operation. If the downloading is continued, the display shows a message about it.</p>	<pre> LOC ↻ PAR BACKUP——3 MAKE BACKUP TO PANEL SHOW BACKUP INFO RESTORE PARS ALL RESTORE PARS NO-IDRUN RESTORE PARS IDRUN EXIT 00:00 SEL LOC ↻ PAR BACKUP—— Initializing param. restore operation 00:00 LOC ↻ VERSION CHECK -1 BACKUP INTERFACE VER 0.2 0.2 OK FIRMWARE VERSION CANCEL 00:00 CONT LOC ↻ PAR BACKUP—— Initializing param. restore operation 00:00 </pre>

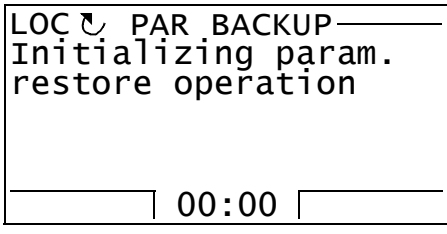

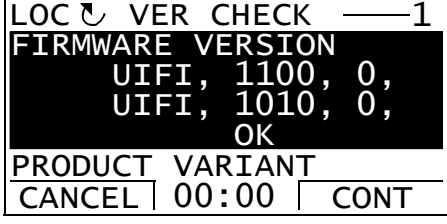
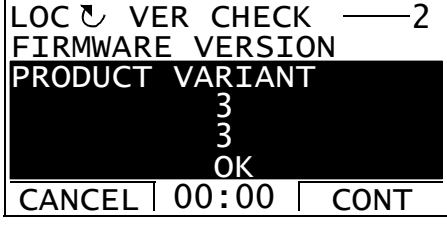

Step	Action	Display
	Downloading continues, drive is being restarted.	
	<p>The display shows the transfer status as a percentage of completion.</p> <p>Downloading finishes.</p>	 

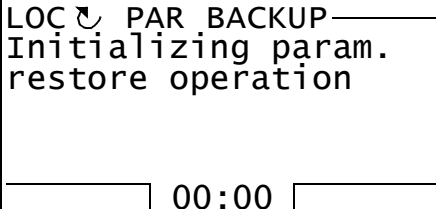
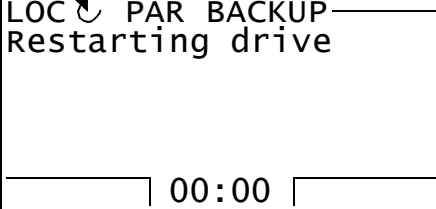
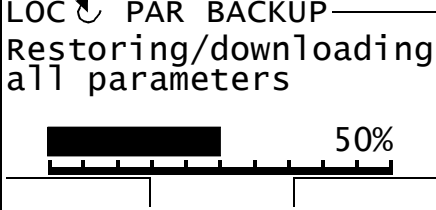
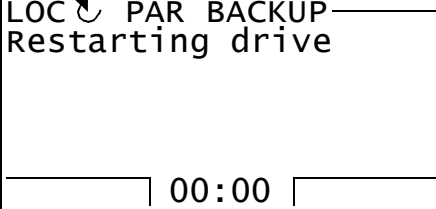
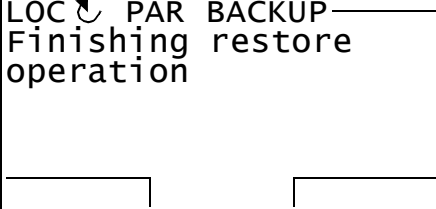
Parameter errors

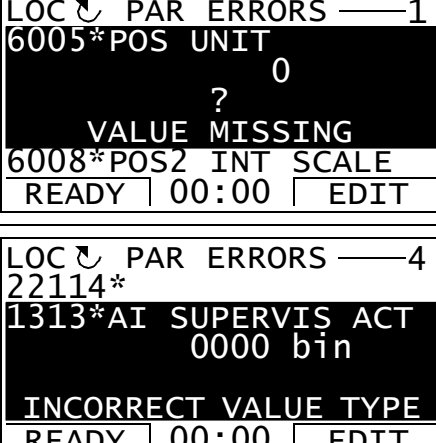
If you try to backup and restore parameters between different firmware versions, the panel shows you the following parameter error information:



Step	Action	Display
1.	Restore operation starts normally.	
2.	<p>Firmware version is checked. You can see on the panel that the firmware versions are not the same.</p> <p>Scroll the text with keys  and . To continue, press . Press  to stop the operation.</p>	 

Step	Action	Display
3.	If the downloading is continued, the display shows a message about it.	
	Downloading continues, drive is being restarted.	
	The display shows the transfer status as a percentage of completion.	
	Downloading continues.	
	Downloading finishes.	
4.	<p>The panel shows a list of erroneous parameters.</p> <p>You can scroll the parameters with keys  and . The reason for parameter error is also shown.</p>	

Step	Action	Display
5.	You can edit parameters by pressing  when EDIT command is visible. Parameter <i>60.05 Pos unit</i> is used as an example. Edit the parameter as shown in section <i>Parameters</i> on page 23.	<pre> LOC ↵ PAR EDIT 6005 POS UNIT Revolution [0] CANCEL 00:00 SAVE </pre>
6.	Press  to save the new value. Press  to return to the list of erroneous parameters.	<pre> LOC ↵ PAR EDIT 6005 POS UNIT Degree [1] CANCEL 00:00 SAVE </pre>
7.	The parameter value you chose is visible under the parameter name. Press  when you have finished editing the parameters.	<pre> LOC ↵ PAR ERRORS —1 6005*POS UNIT 1 ? VALUE MISSING 6008*POS2 INT SCALE READY 00:00 EDIT </pre>

Trying to restore a user set between different firmware versions









If you try to backup and restore a user set between different firmware versions, the panel shows you the following alarm information:

Step	Action	Display
1.	Restore operation starts normally.	<pre> LOC ↵ PAR BACKUP Initializing param. restore operation 00:00 </pre>
2.	Version check is also OK. You can see on the panel that the firmware versions are not the same. You can scroll the text with keys  and  .	<pre> LOC ↵ VER CHECK —1 FIRMWARE VERSION UIF1, 1100, 0, UMFI, 1010, 0, OK PRODUCT VARIANT CANCEL 00:00 CONT </pre> <pre> LOC ↵ VER CHECK —2 FIRMWARE VERSION PRODUCT VARIANT 3 3 OK CANCEL 00:00 CONT </pre>



Step	Action	Display
3.	If the downloading is continued, the display shows a message about it.	<div style="border: 1px solid black; padding: 5px;"> <p>LOC ↻ PAR BACKUP</p> <p>Initializing param. restore operation</p> <hr/> <p style="text-align: center;">00:00</p> </div>
4.	Downloading continues, drive is being restarted.	<div style="border: 1px solid black; padding: 5px;"> <p>LOC ↻ PAR BACKUP</p> <p>Restarting drive</p> <hr/> <p style="text-align: center;">00:00</p> </div>
5.	The display shows the transfer status as a percentage of completion.	<div style="border: 1px solid black; padding: 5px;"> <p>LOC ↻ PAR BACKUP</p> <p>Restoring/downloading user set 1</p> <div style="text-align: right; margin-top: 10px;">  <p>50%</p> </div> <hr/> </div>
6.	Downloading continues.	<div style="border: 1px solid black; padding: 5px;"> <p>LOC ↻ PAR BACKUP</p> <p>Initializing param. restore operation</p> <hr/> <p style="text-align: center;">00:00</p> </div>
7.	Downloading continues, drive is being restarted.	<div style="border: 1px solid black; padding: 5px;"> <p>LOC ↻ PAR BACKUP</p> <p>Restarting drive</p> <hr/> <p style="text-align: center;">00:00</p> </div>
8.	Downloading finishes.	<div style="border: 1px solid black; padding: 5px;"> <p>LOC ↻ PAR BACKUP</p> <p>Finishing restore operation</p> <hr/> </div>
9.	Panel shows a text identifying the alarm and returns to the Par Backup.	<div style="border: 1px solid black; padding: 5px;"> <p>LOC ↻ ALARM</p> <p>ALARM 2036 RESTORE</p> <hr/> <p style="text-align: center;">EXIT</p> </div>









Trying to load a user set between different firmware versions

If you try load a user set between different firmware versions, the panel shows you the following fault information:

Step	Action	Display
1.	Go to the Parameters option by selecting PARAMETERS on the main menu as shown in section Parameters on page 23. A user set is loaded through parameter 16.09 User set sel . Select parameter group 16 System with keys  and  .	<pre> LOC ↻ PAR GROUPS——16 12 Operating mode 13 Analogue inputs 14 Digital I/O 15 Analogue outputs 16 System EXIT 00:00 SEL </pre>
2.	Press  to select parameter group 16. Select parameter 16.09 User set sel with keys  and  . Current value of each parameter is shown below its name.	<pre> LOC ↻ PARAMETERS—— 1603 Pass code 1604 Param restore 1607 Param save 1609 User set sel No request EXIT 00:00 EDIT </pre>
3.	Press  . Select the user set you want to load with keys  and  . Press  .	<pre> LOC ↻ PAR EDIT—— 1609 User set sel No request [1] CANCEL 00:00 SAVE </pre> <pre> LOC ↻ PAR EDIT—— 1609 User set sel Load set 1 [2] CANCEL 00:00 SAVE </pre>
4.	Panel shows a text identifying the fault.	<pre> LOC ↻ FAULT—— FAULT 310 USERSET LOAD RESET EXIT </pre>

How to view information about the backup

Step	Action	Display
1.	Go to the Main menu by pressing  if you are in the Output mode. Otherwise press  repeatedly until you get to the Main menu.	<pre> LOC ↻ MAIN MENU——1 PARAMETERS ASSISTANTS CHANGED PAR EXIT 00:00 ENTER </pre>















Step	Action	Display
2.	Go to the Par Backup option by selecting PAR BACKUP on the menu with keys  and  , and pressing  . Select SHOW BACKUP INFO with keys  and  .	<pre> LOC ↻ PAR BACKUP——2 MAKE BACKUP TO PANEL SHOW BACKUP INFO RESTORE PARS ALL RESTORE PARS NO-IDRUN RESTORE PARS IDRUN EXIT 00:00 SEL </pre>
3.	Press  . The display shows the following information about the drive from where the backup was made: BACKUP INTERFACE VER: Format version of the backup file FIRMWARE VERSION: Information on the firmware UIF: Firmware of the ACS850 drive 1100: Firmware version (e.g. 1.100) 0: Firmware patch version PRODUCT VARIANT: 3: ACS850 (Standard control program) 4: ACS850 FA (Variant for factory applications) You can scroll the information with keys  and  .	<pre> LOC ↻ BACKUP INFO—— BACKUP INTERFACE VER 0.3 0.3 FIRMWARE VERSION UIF, 1100, 0, EXIT 00:00 </pre> <pre> LOC ↻ BACKUP INFO—— FIRMWARE VERSION UIF, 1100, 0, UIF, 1100, 0, PRODUCT VARIANT 3 EXIT 00:00 </pre>
4.	Press  to return to the Par Backup.	<pre> LOC ↻ PAR BACKUP——1 MAKE BACKUP TO PANEL SHOW BACKUP INFO RESTORE PARS ALL RESTORE PARS NO-IDRUN RESTORE PARS IDRUN EXIT 00:00 SEL </pre>







I/O Settings

In the I/O Settings mode, you can:

- check the parameter settings that configure the I/Os of the drive
- check the parameters that have an input or output selected as their source or target
- edit the parameter setting
- start, stop, change the direction and switch between local and remote control.

How to edit and change parameter settings related to I/O terminals

Step	Action	Display
1.	Go to the Main menu by pressing  if you are in the Output mode. Otherwise press  repeatedly until you get to the Main menu.	<pre> LOC ↻ MAIN MENU ——— 1 PARAMETERS ASSISTANTS CHANGED PAR EXIT 00:00 ENTER </pre>
2.	Go the I/O Settings mode by selecting I/O SETTINGS on the menu with keys  and  , and pressing  . Select the I/O group, e.g. Digital inputs, with keys  and  .	<pre> LOC ↻ I/O SETTINGS — 1 Analog outputs Analog inputs Digital I/Os Digital inputs Relay outputs EXIT 00:00 SEL </pre> <pre> LOC ↻ I/O SETTINGS — 4 Analog outputs Analog inputs Digital I/Os Digital inputs Relay outputs EXIT 00:00 SEL </pre>
3.	Press  . After a brief pause, the display shows the current settings for the selection. You can scroll digital inputs and parameters with keys  and  .	<pre> LOC ↻ I/O SETTINGS — 1 DI1 1002 Ext1 start in1 DI2 DI3 1010 Fault reset sel EXIT 00:00 INFO </pre>
4.	Press  . The panel shows information related to I/O selected (in this case, DI1). You can scroll information with keys  and  . Press  to return to the digital inputs.	<pre> LOC ↻ I/O INFO ——— NUM OF I/O ITEMS 0 SLOT NUMBER 0 NODE NUMBER EXIT 00:00 </pre>

Step	Action	Display
5.	Select the setting (line with a parameter number) with keys  and  . You can edit the parameter (INFO selection turns into EDIT selection).	<pre> LOC ↻ I/O SETTINGS—1 DI1 1002 Ext1 start in1 DI2 DI3 1010 Fault reset sel EXIT 00:00 EDIT </pre>
6.	Press  .	<pre> LOC ↻ PAR EDIT— 1002 Ext1 start in1 DI1 [P.02.01.00] CANCEL 00:00 SEL </pre>
7.	Specify a new value for the setting with keys  and  . Pressing the key once increments or decrements the value. Holding the key down changes the value faster. Pressing the keys simultaneously replaces the displayed value with the default value.	<pre> LOC ↻ PAR EDIT— 1002 Ext1 start in1 DI04 [P.02.03.03] CANCEL 00:00 SEL </pre>
8.	To save the new value, press  . To cancel the new value and keep the original, press  .	<pre> LOC ↻ I/O SETTINGS—1 DI1 1002 Ext1 start in1 DI2 DI3 1010 Fault reset sel EXIT 00:00 EDIT </pre>











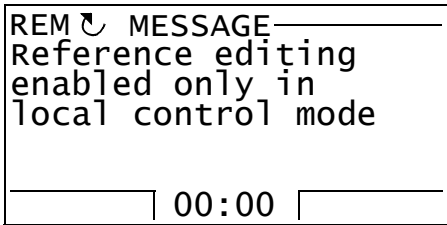

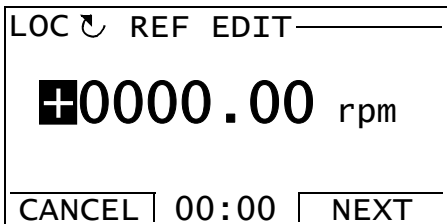

■ Reference Edit

In the Reference Edit option, you can:

- accurately control the local reference value,
- start, stop, change the direction and switch between local and remote control.

Editing is allowed only in the LOC state, the option always edits the local reference value.

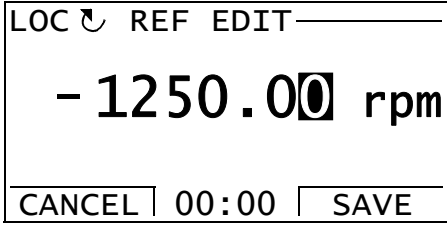
How to edit reference value

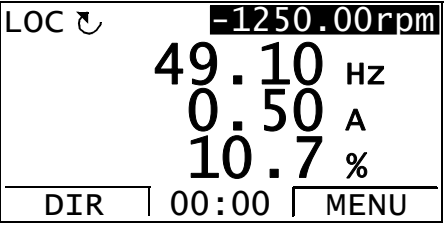









Step	Action	Display
1.	If the panel is in the remote control mode (REM shown on the status line), switch to local control (LOC shown on the status line) by pressing  . Reference editing is not possible in remote control mode. (See page 20 for more information on switching between the local and remote control modes.) The display shows a message about that if you try to enter REF EDIT in the remote control mode.	
2.	Otherwise, go to the Main menu by pressing  if you are in the Output mode. Otherwise press  repeatedly until you get to the Main menu.	
3.	Go to the Reference Edit option by selecting REF EDIT on the menu with keys  and  , and pressing  .	
4.	Select the correct sign with keys  and  , and press  . Select the correct numbers with keys  and  , and after each number is selected, press  .	
5.	After the last number is selected, press  . Go to the Output mode by pressing  . The selected reference value is shown in the status line.	

■ Drive Info

In the Drive Info option, you can:

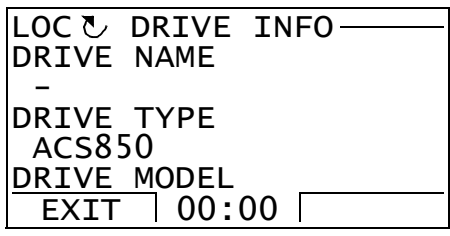
- view information on the drive,
- start, stop, change the direction and switch between local and remote control.

How to view drive info

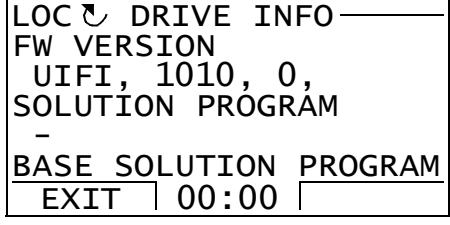













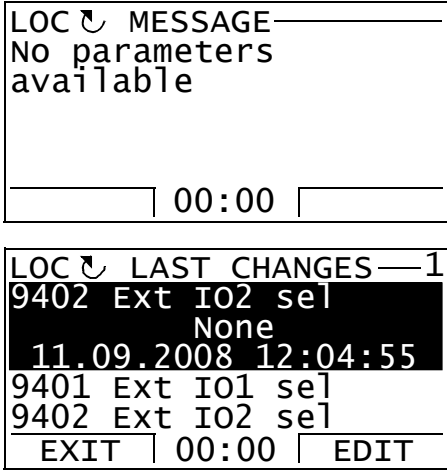

Step	Action	Display
1.	Go to the Main menu by pressing  if you are in the Output mode. Otherwise press  repeatedly until you get to the Main menu.	
2.	Go to the Drive info option by selecting DRIVE INFO on the menu with keys  and  , and pressing  .	
3.	The display shows information about the drive. You can scroll the information with keys  and  . Note: The information shown may vary according to the firmware version of the drive. DRIVE NAME: Drive name defined as a text in DriveStudio commissioning and maintenance tool DRIVE TYPE: e.g. ACS850 DRIVE MODEL: Type code of the drive FW VERSION: See page 44. SOLUTION PROGRAM: Version information of the active solution program BASE SOLUTION PROGRAM: Version information of the solution program template STANDARD LIBRARY: Version information of the standard library TECHNOLOGY LIBRARY: Optional. Version information of the technology library POWER UNIT SERNO: Serial number of the power stage (JPU) MEM UNIT HW SERNO: Serial number in manufacturing the memory unit (JMU) MEM UNIT CONFIG SERNO: Serial number in configuring the memory unit (JMU). Press  to return to the Main menu.	

■ Parameter Change Log

In the Parameter Change Log option, you can:

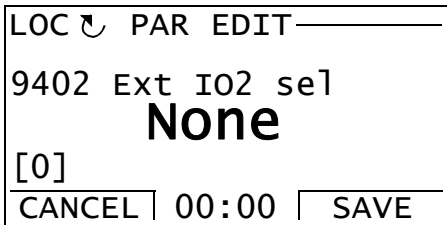
- view latest parameter changes made via control panel or PC tool,
- edit these parameters,
- start, stop, change the direction and switch between local and remote control.

How to view latest parameter changes and edit parameters

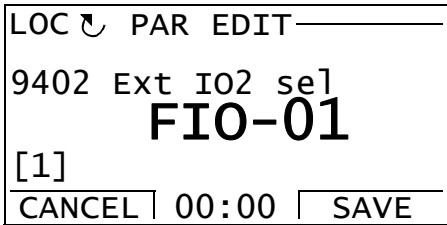
Step	Action	Display
1.	Go to the Main menu by pressing  if you are in the Output mode. Otherwise press  repeatedly until you get to the Main menu.	
2.	Go to the Parameter Change Log option by selecting PAR CHG LOG on the menu with keys  and  , and pressing  . If there are no parameter changes in the history, corresponding text will be shown. If there are parameter changes in the history, the panel shows a list of the last parameter changes starting from the most recent change. The order of the changes is also indicated with a number in the top right corner (1 stands for most recent change, 2 the second latest change etc.) If a parameter has been changed twice, it is shown as one change in the list. The current value of the parameter and the parameter change date and time are also shown below the selected parameter. You can scroll the parameters with keys  and  .	
3.	If you want to edit a parameter, select the parameter with keys  and  and press  .	
4.	Specify a new value for the parameter with keys  and  . To save the new value, press  . To cancel the new value and keep the original, press  .	

Step	Action	Display
5.	<p>The parameter change is shown as the first one in the list of last parameter changes.</p> <p>Note: You can reset the parameter change log by setting parameter 16.14 Reset ChgParLog to Reset.</p>	<pre> LOC ↵ LAST CHANGES — 1 9402 Ext I02 sel FIO-01 12.09.2008 15:09:33 9402 Ext I02 sel 9401 Ext I01 sel EXIT 00:00 EDIT </pre>



Control locations and operating modes

What this chapter contains

This chapter describes the control locations and operating modes of the drive.

Local control vs. external control

The drive has two main control locations: external and local. The control location is selected with the LOC/REM key on the control panel or with the PC tool (Take/Release button).

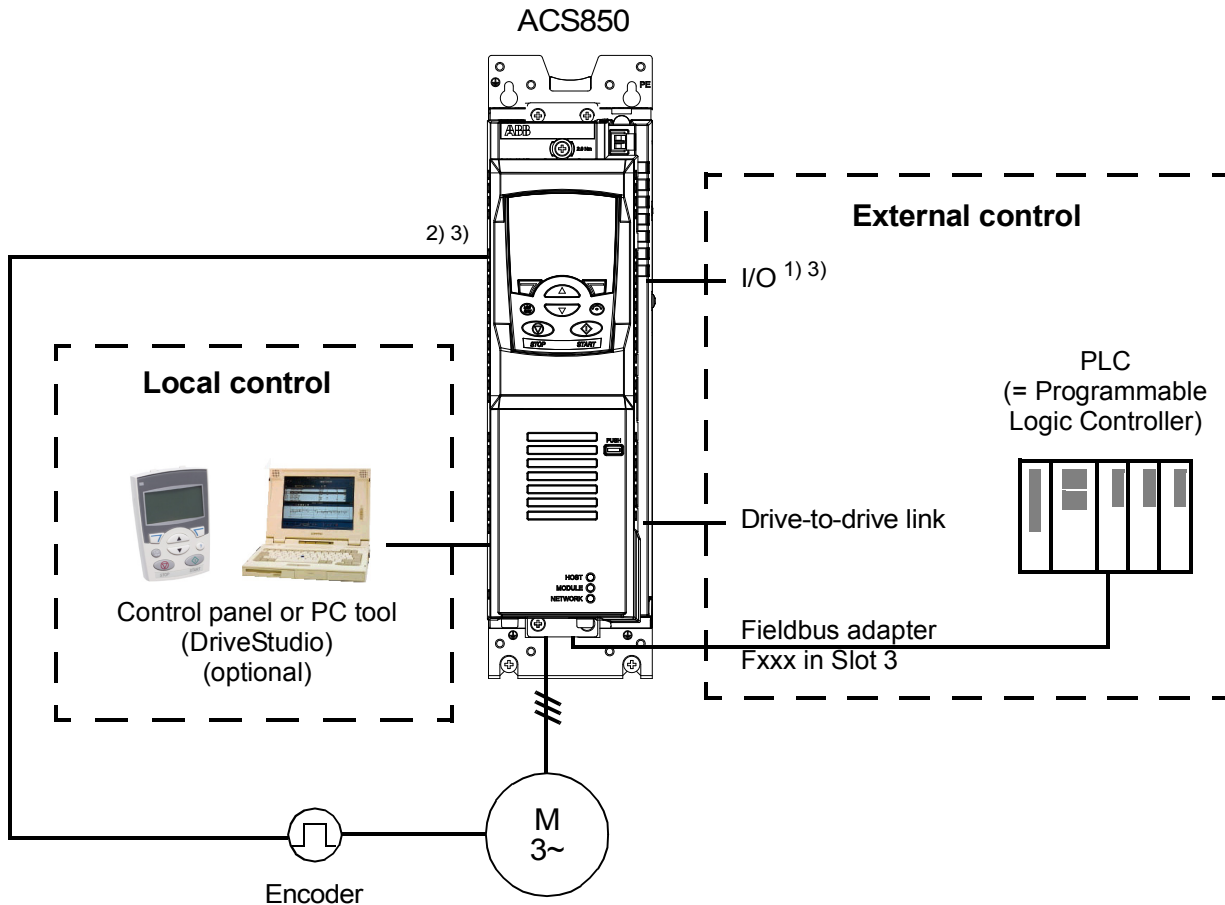

1) Extra inputs/outputs can be added by installing optional I/O extension modules (FIO-xx) in drive Slot 1/2.

2) Encoder or resolver interface module (FEN-xx) installed in drive Slot 1/2

3) Two encoder/resolver interface modules of the same type are not allowed.

■ Local control

The control commands are given from the control panel keypad or from a PC equipped with DriveStudio when the drive is in local control. Speed and torque control modes are available for local control.

Local control is mainly used during commissioning and maintenance. The control panel always overrides the external control signal sources when used in local control. Changing the control location to local can be disabled by parameter [16.01 Local lock](#).

The user can select by a parameter ([30.03 Local ctrl loss](#)) how the drive reacts to a control panel or PC tool communication break.

■ External control

When the drive is in external control, control commands are given through the fieldbus interface (via an optional fieldbus adapter module), the I/O terminals (digital and analogue inputs), optional I/O extension modules or the drive-to-drive link. External references are given through the fieldbus interface, analogue inputs, drive to drive link and encoder inputs.

Two external control locations, EXT1 and EXT2, are available. The user can select control signals (e.g. start and stop) and control modes for both external control locations. Depending on the user selection, either EXT1 or EXT2 is active at a time. Selection between EXT1/EXT2 is done via digital inputs or fieldbus control word.

Operating modes of the drive

The drive can operate in several control modes.

■ Speed control mode

Motor rotates at a speed proportional to the speed reference given to the drive. This mode can be used either with estimated speed used as feedback, or with an encoder or resolver for better speed accuracy.

Speed control mode is available in both local and external control.

■ Torque control mode

Motor torque is proportional to the torque reference given to the drive. This mode can be used either with estimated speed used as feedback, or with an encoder or resolver for more accurate and dynamic motor control.

Torque control mode is available in both local and external control.

■ Special control modes

In addition to the above-mentioned control modes, the following special control modes are available:

- Emergency stop modes OFF1 and OFF3: Drive stops along the defined deceleration ramp and drive modulation stops.
- Jogging mode: Drive starts and accelerates to the defined speed when the jogging signal is activated.

For more information, see parameter group [10 Start/stop](#) on page [109](#).



Program features

What this chapter contains

This chapter describes the features of the control program.

Application macros

See chapter [Application macros](#) (page 81).

Automatic fault resets

The drive can automatically reset itself after overcurrent, overvoltage, undervoltage, external and “analog input below minimum” faults. By default, automatic resets are off and must be separately activated by the user.

Settings

Parameter group [32 Automatic reset](#) (page 182).

Autophasing

Autophasing is an automatic measurement routine to determine the angular position of the magnetic flux of a permanent magnet synchronous motor. The motor control requires the absolute position of the rotor flux in order to control motor torque accurately.

Autophasing is applicable to permanent magnet synchronous motors in these cases:

- One-time measurement of the rotor and encoder position difference when an absolute encoder or resolver (one pole pair) is used
- Measurement at first start after each power-up when an incremental encoder is used
- With open-loop motor control, repetitive measurement of the rotor position at every start.

Several autophasing modes are available (see parameter [11.07 Autophasing mode](#)).

The turning mode is recommended especially with case 1 as it is the most robust and accurate method. In turning mode, the motor shaft is turned back and forward ($\pm 360/\text{polepairs}$)° in order to determine the rotor position. In case 3 (open-loop control), the shaft is turned only in one direction and the angle is smaller.

The standstill modes can be used if the motor cannot be turned (for example, when the load is connected). As the characteristics of motors and loads differ, testing must be done to find out the most suitable standstill mode.

A rotor position offset used in motor control can also be given by the user. See parameter [97.20 PM angle offset](#).

The drive is capable of determining the rotor position when started to a running motor in open-loop or closed-loop modes. In this situation, the setting of [11.07 Autophasing mode](#) has no effect.

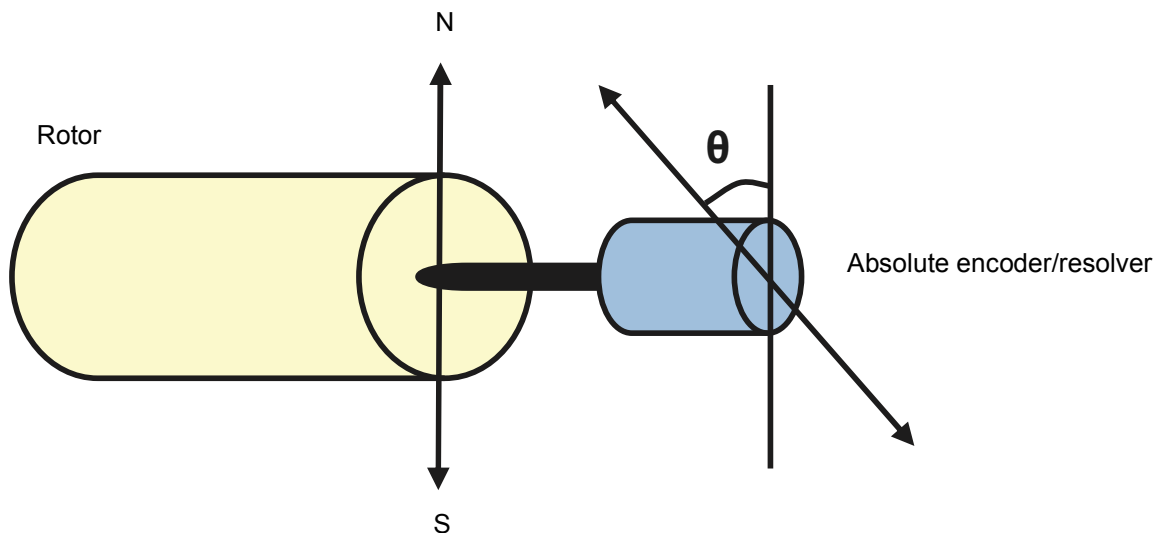

Constant speeds

It is possible to predefine up to 7 constant speeds. Constant speeds can be activated, for example, through digital inputs. Constant speeds override the speed reference.

Settings

Parameter group [26 Constant speeds](#) (page [168](#)).

Critical speeds

A Critical speeds function is available for applications where it is necessary to avoid certain motor speeds or speed ranges because of, for example, mechanical resonance problems.

Settings

Parameter group [25 Critical speed](#) (page [167](#)).

DC voltage control

■ Overvoltage control

Overvoltage control of the intermediate DC link is needed with two-quadrant line-side converters when the motor operates within the generating quadrant. To prevent the DC voltage from exceeding the overvoltage control limit, the overvoltage controller automatically decreases the generating torque when the limit is reached.

■ Undervoltage control

If the incoming supply voltage is cut off, the drive will continue to operate by utilizing the kinetic energy of the rotating motor. The drive will be fully operational as long as the motor rotates and generates energy to the drive. The drive can continue the operation after the break if the main contactor remained closed.

Note: Units equipped with a main contactor must be equipped with a hold circuit (e.g. UPS) to keep the contactor control circuit closed during a short supply break.

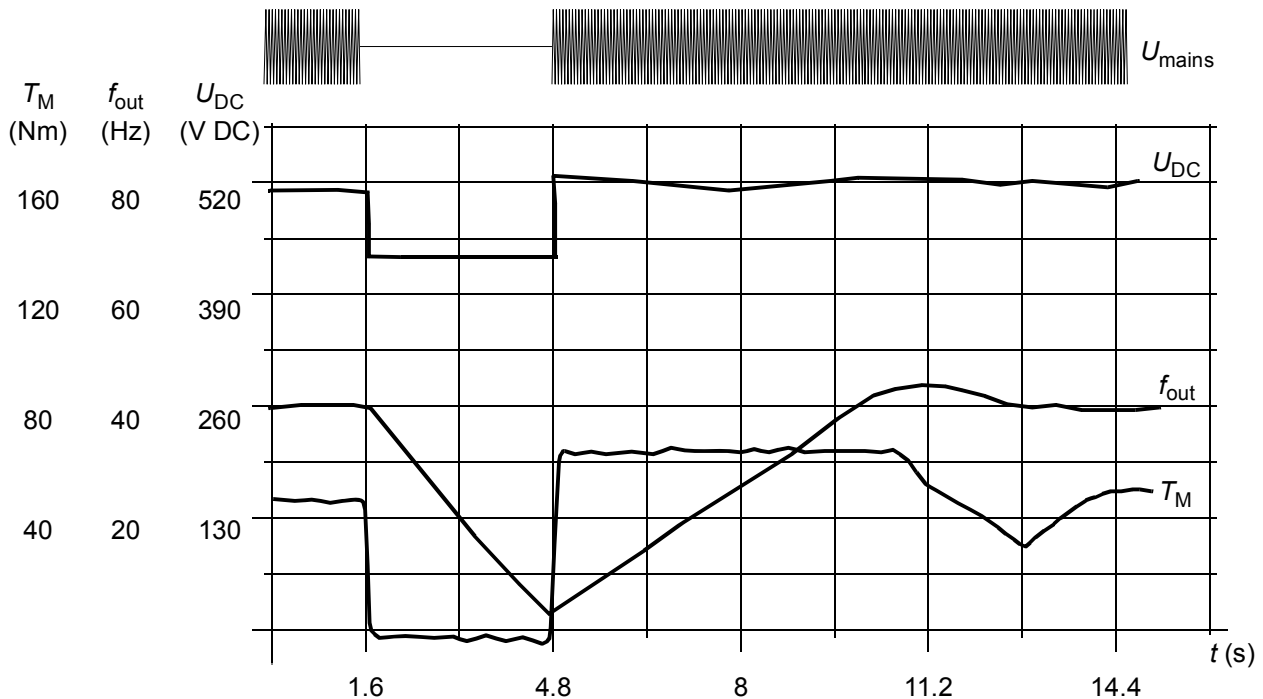

U_{DC} = intermediate circuit voltage of the drive, f_{out} = output frequency of the drive,
 T_M = motor torque

Loss of supply voltage at nominal load ($f_{out} = 40$ Hz). The intermediate circuit DC voltage drops to the minimum limit. The controller keeps the voltage steady as long as the mains is switched off. The drive runs the motor in generator mode. The motor speed falls but the drive is operational as long as the motor has enough kinetic energy.

■ Voltage control and trip limits

The control and trip limits of the intermediate DC voltage regulator are relative either to a supply voltage value provided by the user, or to an automatically-determined supply voltage. The actual voltage used is shown by parameter [01.19 Used supply volt](#). The DC voltage (U_{DC}) equals 1.35 times this value.

Automatic identification of the supply voltage is performed every time the drive is powered on. Automatic identification can be disabled by parameter [47.03 SupplyVoltAutold](#); the user can then define the voltage manually at parameter [47.04 Supply voltage](#).

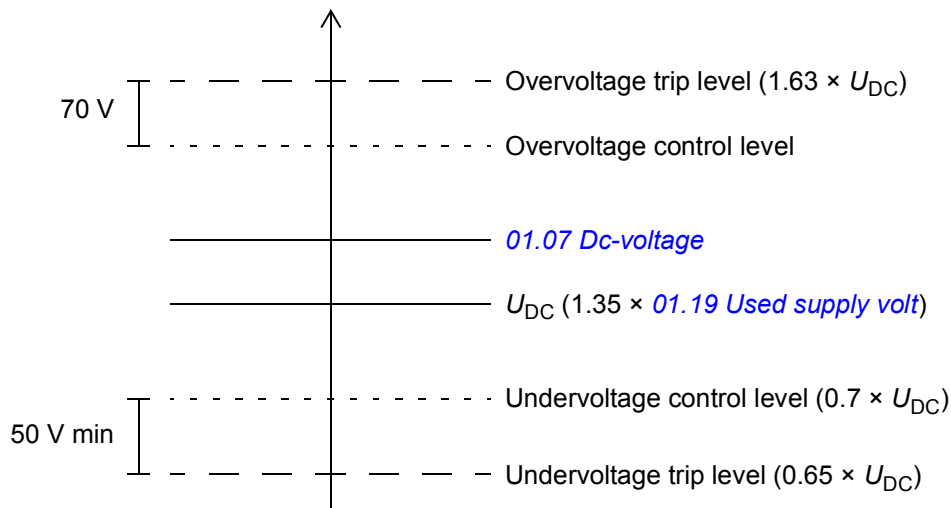

The intermediate DC circuit is charged over an internal resistor which is bypassed when the correct level (80% of U_{DC}) is reached and voltage is stabilized.

Settings

Parameter group [47 Voltage ctrl](#) (page [212](#)).

■ Brake chopper

The built-in brake chopper of the drive can be used to handle the energy generated by a decelerating motor.

When the brake chopper is enabled and a resistor connected, the chopper will start conducting when the DC link voltage of the drive reaches 780 V. The maximum braking power is achieved at 840 V.

Settings

Parameter group [48 Brake chopper](#) (page [212](#)).

Drive-to-drive link

The drive-to-drive link is a daisy-chained RS-485 transmission line that allows basic master/follower communication with one master drive and multiple followers.

The wiring of the drive-to-drive link is presented in the hardware manual of the drive.

Settings

Parameter group [57 D2D communication](#) (page [218](#)).

Emergency stop

Note: The user is responsible for installing the emergency stop devices and all the additional devices needed for the emergency stop to fulfil the required emergency stop category classes. For more information, contact your local ABB representative.

The emergency stop signal is to be connected to the digital input which is selected as the source for the emergency stop activation (par. [10.13 Em stop off3](#) or [10.15 Em stop off1](#)). Emergency stop can also be activated through fieldbus ([02.22 FBA main cw](#)).

Note: When an emergency stop signal is detected, the emergency stop function cannot be cancelled even though the signal is cancelled.

Encoder support

The program offers support for two encoders (or resolvers), encoder 1 and 2. Multiturn encoders are supported only as encoder 1. Three optional interface modules are available:

- TTL Encoder Interface FEN-01: two TTL inputs, TTL output (for encoder emulation and echo) and two digital inputs for position latching
- Absolute Encoder Interface FEN-11: absolute encoder input, TTL input, TTL output (for encoder emulation and echo) and two digital inputs for position latching
- Resolver Interface FEN-21: resolver input, TTL input, TTL output (for encoder emulation echo) and two digital inputs for position latching.
- HTL Encoder Interface FEN-31: HTL encoder input, TTL output (for encoder emulation and echo) and two digital inputs for position latching.

The interface module is connected to drive option Slot 1 or 2. **Note:** Two encoder interface modules of the same type are not allowed.

Settings

Parameter groups [91 Absol enc conf](#) (page 225), [92 Resolver conf](#) (page 228) and [93 Pulse enc conf](#) (page 228).

Energy optimizer

The energy optimizer optimizes the flux so that the total energy consumption and motor noise level are reduced when the drive operates below the nominal load. The total efficiency of the drive system can be improved by 1...10% depending on load torque and speed.

The energy saving tools calculate the energy saved in kWh and in local currency, and as reduction in CO₂ emissions, all compared to the situation where the pump is directly connected to the supply.

Note: The accuracy of the energy savings calculation is directly dependent on the accuracy of the reference motor power given in parameter [45.08 Pump ref power](#).

Settings

Parameter group [45 Energy optimising](#) (page [211](#)).

Fieldbus control

See chapter [Fieldbus control](#) (page [277](#)).

Jogging

Two jogging functions (1 or 2) are available. When a jogging function is activated, the drive starts and accelerates to the defined jogging speed along the defined jogging acceleration ramp. When the function is deactivated, the drive decelerates to a stop along the defined jogging deceleration ramp. One push button can be used to start and stop the drive during jogging. The jogging function is typically used during servicing or commissioning to control the machinery locally.

Jogging functions 1 and 2 are activated by a parameter or through fieldbus. For activation through fieldbus, see parameter [02.22 FBA main cw](#).

The figure and table below describe the operation of the drive during jogging. (Note that they cannot be directly applied to jogging commands through fieldbus as those require no enable signal; see parameter [10.09 Jog enable](#).) They also represent how the drive shifts to normal operation (= jogging inactive) when the drive start command is switched on. Jog cmd = State of the jogging input; Jog enable = Jogging enabled by the source set by parameter [10.09 Jog enable](#); Start cmd = State of the drive start command.

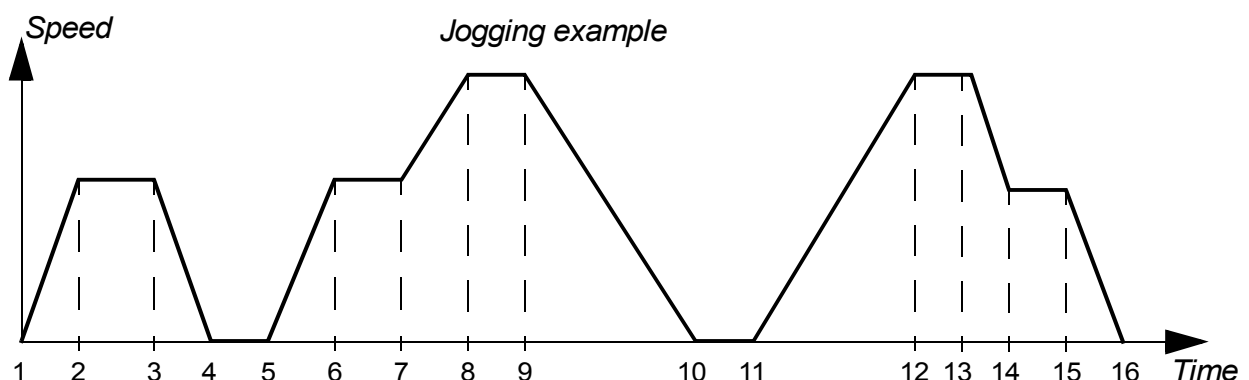

Phase	Jog cmd	Jog enable	Start cmd	Description
1-2	1	1	0	Drive accelerates to the jogging speed along the acceleration ramp of the jogging function.

Phase	Jog cmd	Jog enable	Start cmd	Description
2-3	1	1	0	Drive runs at the jogging speed.
3-4	0	1	0	Drive decelerates to zero speed along the deceleration ramp of the jogging function.
4-5	0	1	0	Drive is stopped.
5-6	1	1	0	Drive accelerates to the jogging speed along the acceleration ramp of the jogging function.
6-7	1	1	0	Drive runs at the jogging speed.
7-8	x	0	1	Jog enable is not active; normal operation continues.
8-9	x	0	1	Normal operation overrides the jogging. Drive follows the speed reference.
9-10	x	0	0	Drive decelerates to zero speed along the active deceleration ramp.
10-11	x	0	0	Drive is stopped.
11-12	x	0	1	Normal operation overrides the jogging. Drive accelerates to the speed reference along the active acceleration ramp.
12-13	1	1	1	Start command overrides the jog enable signal.
13-14	1	1	0	Drive decelerates to the jogging speed along the deceleration ramp of the jogging function.
14-15	1	1	0	Drive runs at the jogging speed.
15-16	x	0	0	Drive decelerates to zero speed along the deceleration ramp of the jogging function.

Note: Jogging is not operational when the drive start command is on, or if the drive is in local control.

Note: The ramp shape time is set to zero during jogging.

Load analyzer

■ Peak value logger

The user can select a signal to be monitored by the peak value logger. The logger records the peak value of the signal along with the time the peak occurred, as well as motor current, DC voltage and motor speed at the time of the peak.

■ Amplitude loggers

The drive has two amplitude loggers.

For amplitude logger 2, the user can select a signal to be sampled at 200 ms intervals when the drive is running, and specify a value that corresponds to 100%. The collected samples are sorted into 10 read-only parameters according to their amplitude. Each parameter represents an amplitude range 10 percentage points wide, and displays the percentage of the collected samples that fall within that range.

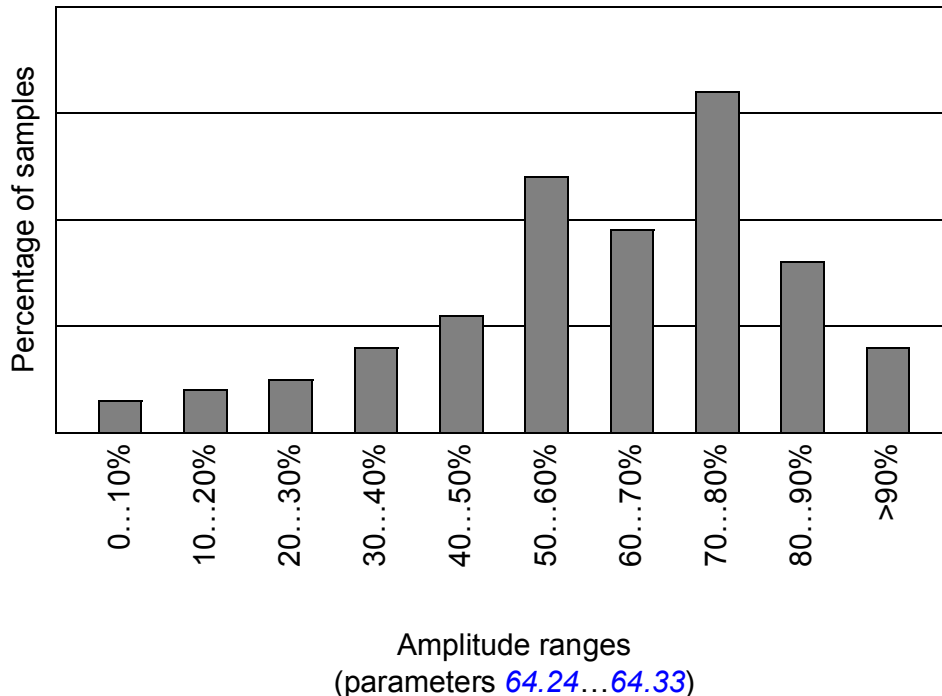

Amplitude logger 1 is fixed to monitor motor current, and cannot be reset. With amplitude logger 1, 100% corresponds to the nominal output current of the drive (I_{2N}).

Settings

Parameter group [64 Load analyzer](#) (page [220](#)).

Maintenance counters

The program has six different maintenance counters that can be configured to generate an alarm when the counter reaches a pre-defined limit. The counter can be set to monitor any parameter. This feature is especially useful as a service reminder.

There are three types of counters:

- Ontime counter. Measures the time a digital source (for example, a bit in a status word) is on.
- Rising edge counter. This counter is incremented whenever the monitored digital source changes state from 0 to 1.
- Value counter. This counter measures, by integration, the monitored parameter. An alarm is given when the calculated area below the signal peak exceeds a user-defined limit.

Settings

Parameter group [44 Maintenance](#) (page [205](#)).

Mechanical brake control

A mechanical brake can be used for holding the motor and driven machinery at zero speed when the drive is stopped, or not powered.

Parameters [03.15 Brake torq mem](#) and [03.16 Brake command](#) show the torque value stored when the brake close command is issued and the value of the brake command respectively.

Settings

Parameter group [42 Mech brake ctrl](#) (page [201](#)).

BSM = Brake State Machine

* Depending on setting of parameter [42.12 Brake fault func](#)

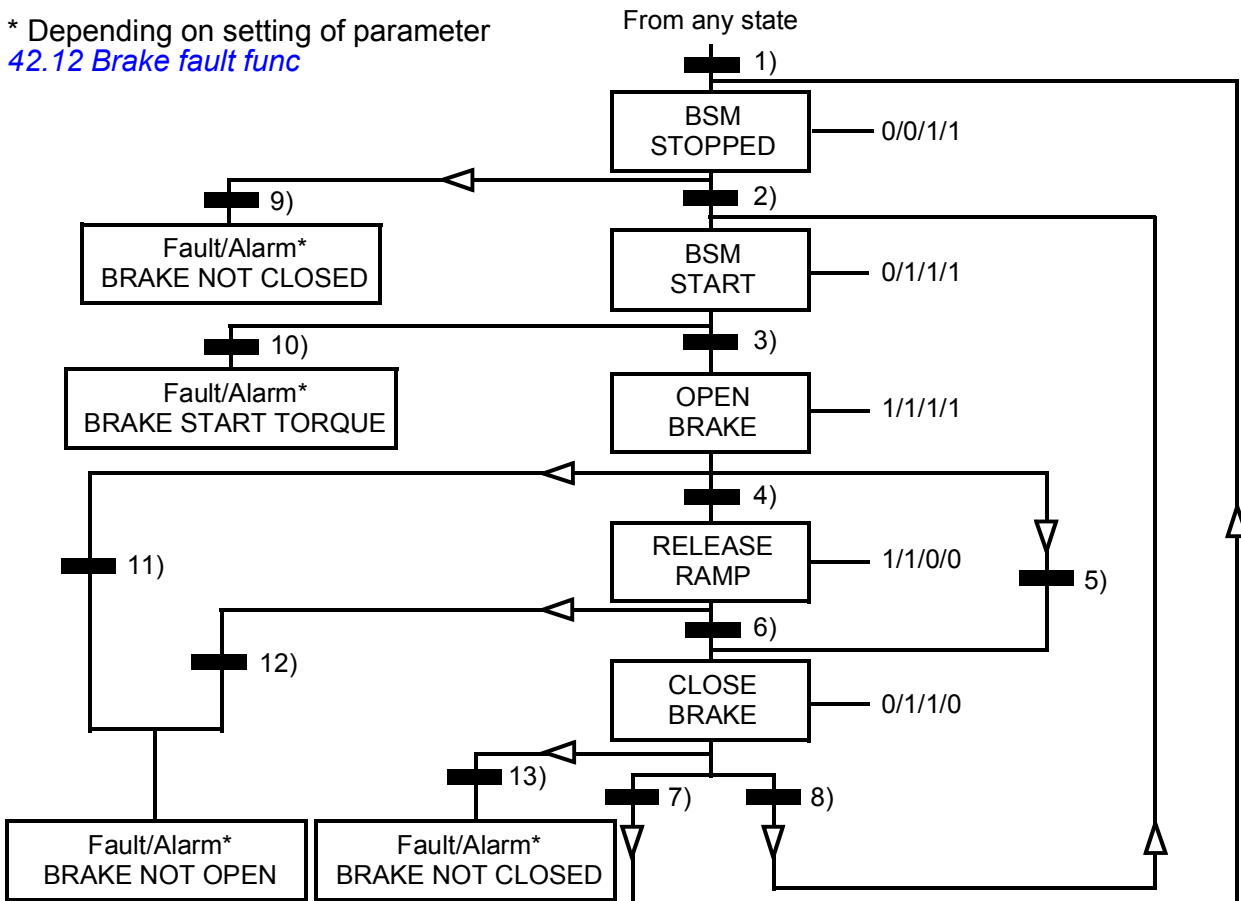

State (Symbol

NN

 — W/X/Y/Z)

- NN: State name

- W/X/Y/Z: State outputs/operations

W: 1 = Brake open command is active. 0 = Brake close command is active. (Controlled through selected digital/relay output with signal [03.16 Brake command](#).)

- X: 1 = Forced start (inverter is modulating). The function keeps the internal start command on until the brake is closed in spite of the status of the external stop command. Effective only when ramp stop has been selected as the stop mode ([11.03 Stop mode](#)). Run enable and faults override the forced start. 0 = No forced start (normal operation).
- Y: 1 = Drive control mode is forced to speed/scalar.
- Z: 1 = Ramp generator output is forced to zero. 0 = Ramp generator output is enabled (normal operation).

State change conditions (Symbol)

- 1) Brake control is active ([42.01 Brake ctrl](#) = *With ack* or *No ack*) OR modulation of the drive is requested to stop. The drive control mode is forced to speed/scalar.
 - 2) External start command is on AND brake open request is on (source selected by [42.10 Brake close req](#) is 0) AND reopen delay ([42.07 Reopen delay](#)) has elapsed.
 - 3) Starting torque required at brake release is reached ([42.08 Brake open torq](#)) AND brake hold is not active ([42.11 Brake hold open](#)). **Note:** With scalar control, the defined starting torque has no effect.
 - 4) Brake is open (acknowledgement source selected by par. [42.02 Brake acknowl](#) is 1) AND the brake open delay has elapsed ([42.03 Open delay](#)). Start = 1.
 - 5) 6) Start = 0 OR brake close command is active AND actual motor speed < brake close speed ([42.05 Close speed](#)) AND close command delay ([42.06 Close cmd delay](#)) has elapsed.
 - 7) Brake is closed (acknowledgement = 0) AND brake close delay ([42.04 Close delay](#)) has elapsed. Start = 0.
 - 8) Start = 1 AND brake open request is on (source selected by [42.10 Brake close req](#) is 0) AND reopen delay has elapsed.
 - 9) Brake is open (acknowledgement = 1) AND brake close delay has elapsed.
 - 10) Defined starting torque at brake release is not reached.
 - 11) Brake is closed (acknowledgement = 0) AND brake open delay has elapsed.
 - 12) Brake is closed (acknowledgement = 0).
 - 13) Brake is open (acknowledgement = 1) AND brake close delay has elapsed. Fault is generated after brake close fault delay ([42.13 Close flt delay](#)) has elapsed.
-

Operation time scheme

The simplified time scheme below illustrates the operation of the brake control function.

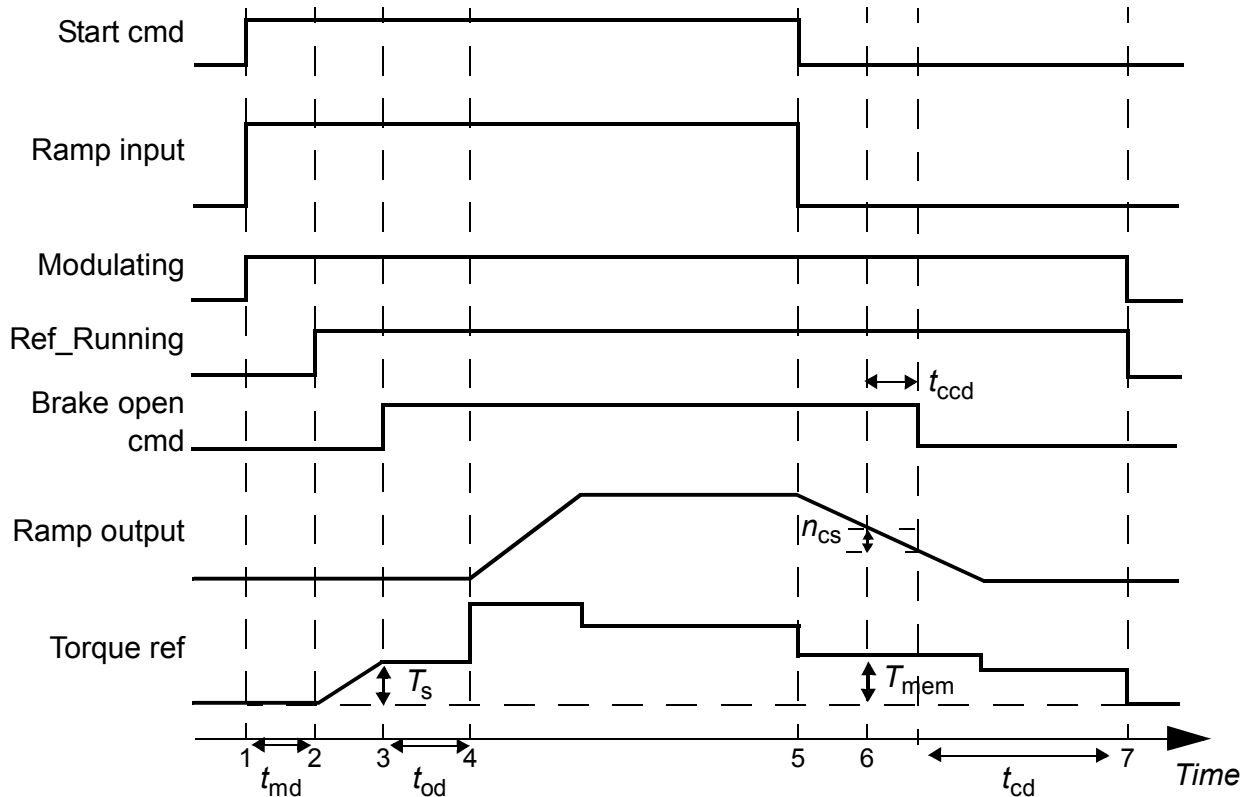

- T_s Start torque at brake release (parameter [42.08 Brake open torq](#))
- T_{mem} Stored torque value at brake close (signal [03.15 Brake torq mem](#))
- t_{md} Motor magnetising delay
- t_{od} Brake open delay (parameter [42.03 Open delay](#))
- n_{cs} Brake close speed (parameter [42.05 Close speed](#))
- t_{ccd} Brake close command delay (parameter [42.06 Close cmd delay](#))
- t_{cd} Brake close delay (parameter [42.04 Close delay](#))

Example

The figure below shows a brake control application example.



WARNING! Make sure that the machinery into which the drive with brake control function is integrated fulfils the personnel safety regulations. Note that the frequency converter (a Complete Drive Module or a Basic Drive Module, as defined in IEC 61800-2), is not considered as a safety device mentioned in the European Machinery Directive and related harmonised

standards. Thus, the personnel safety of the complete machinery must not be based on a specific frequency converter feature (such as the brake control function), but it has to be implemented as defined in the application specific regulations.

The brake on/off is controlled via signal [03.16 Brake command](#). The source for the brake supervision is selected by parameter [42.02 Brake acknowl](#).

The brake control hardware and wirings need to be done by the user.

- Brake on/off control through selected relay/digital output.
 - Brake supervision through selected digital input.
 - Emergency brake switch in the brake control circuit.
- Brake on/off control through relay output (i.e. parameter [14.42 RO1 src](#) setting is P.03.16.00 = [03.16 Brake command](#)).
 - Brake supervision through digital input DI5 (i.e. parameter [42.02 Brake acknowl](#) setting is P.02.01.04 = [02.01 DI status](#), bit 4)

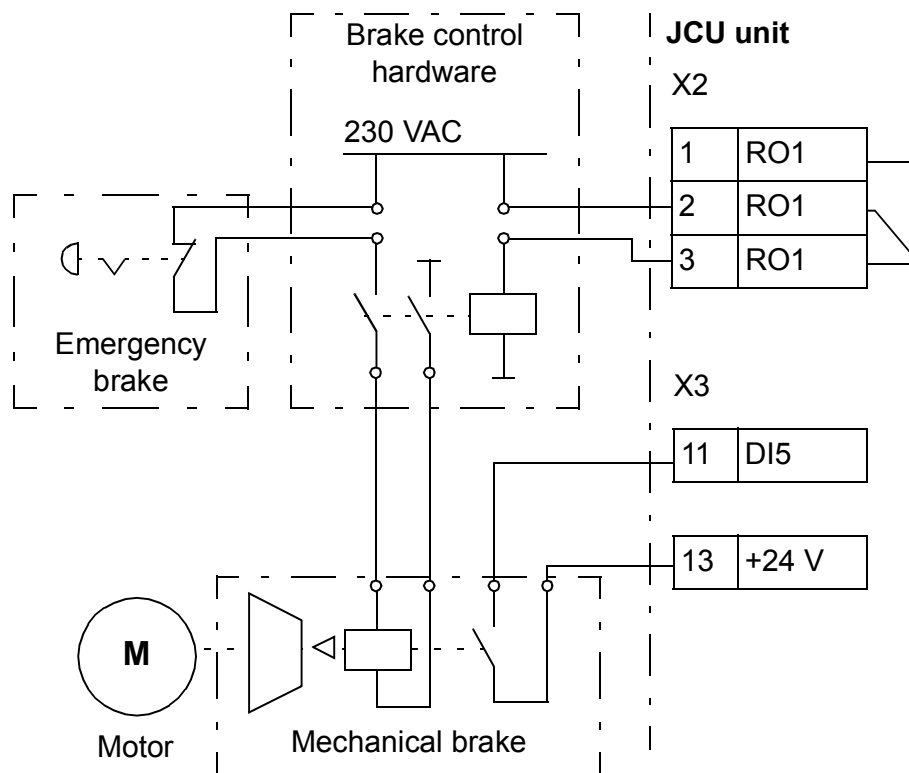

Process PID control

There is a built-in PID controller in the drive. The controller can be used to control process variables such as pressure, flow or fluid level.

In process PID control, a process reference (setpoint) is connected to the drive instead of a speed reference. An actual value (process feedback) is also brought back to the drive. The process PID control adjusts the drive speed in order to keep the measured process quantity (actual value) at the desired level (setpoint).

The simplified block diagram below illustrates the process PID control.

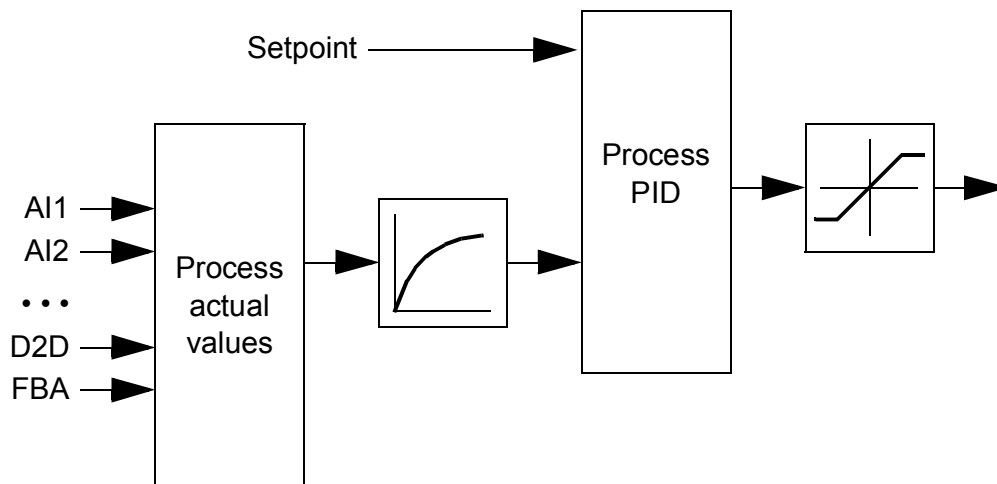

For a more detailed block diagram, see page [292](#).

■ Sleep function for process PID control

The following example visualizes the operation of the sleep function.

The drive controls a pressure boost pump. The water consumption falls at night. As a consequence, the process PID controller decreases the motor speed. However, due to natural losses in the pipes and the low efficiency of the centrifugal pump at low speeds, the motor would never stop rotating. The sleep function detects the slow rotation and stops the unnecessary pumping after the sleep delay has passed. The drive shifts into sleep mode, still monitoring the pressure. The pumping resumes when the pressure falls under the predefined minimum level and the wake-up delay has passed.

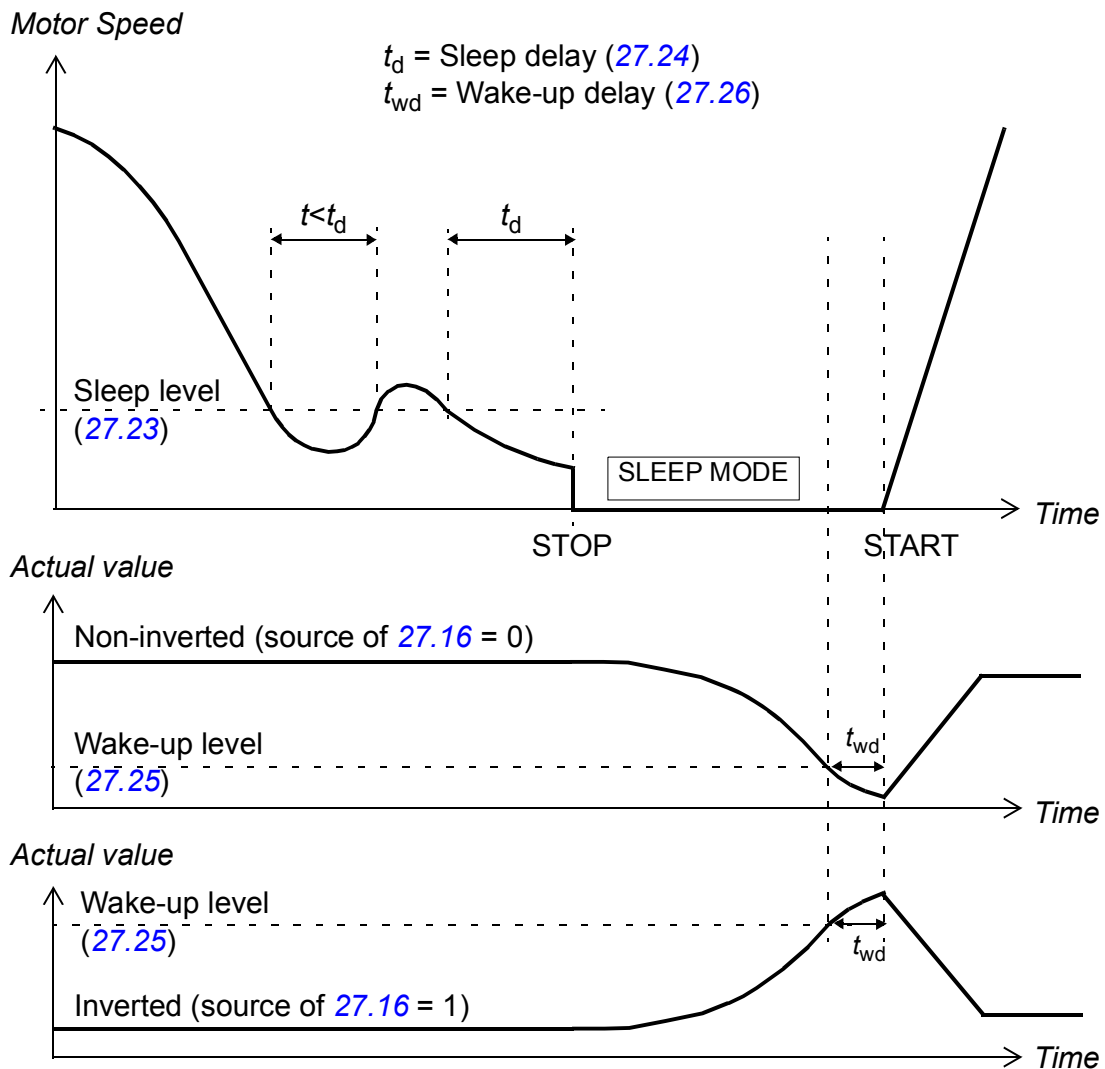

Settings

Parameter group [27 Process PID](#) (page [170](#)).

The PID control macro can be activated from the control panel main menu by selecting ASSISTANTS – Firmware assistants – Application Macro – PID control. See also page [86](#).

Programmable analog inputs

The drive has two programmable analog inputs. Each of the inputs can be independently set as a voltage (0/2...10 V or -10...10 V) or current (0/4...20 mA) input by a jumper on the JCU Control Unit. Each input can be filtered, inverted and scaled. The number of analog inputs can be increased by using FIO-xx I/O extensions.

Settings

Parameter group [13 Analogue inputs](#) (page [119](#)).

Programmable analog outputs

The drive has two current analog outputs. Each output can be filtered, inverted and scaled. The number of analog outputs can be increased by using FIO-xx I/O extensions.

Settings

Parameter group [15 Analogue outputs](#) (page [139](#)).

Programmable digital inputs and outputs

The drive has six digital inputs, a digital start interlock input, and two digital input/outputs.

One digital input (DI6) doubles as a PTC thermistor input. See section [Thermal motor protection](#) on page [76](#).

One of the digital input/outputs can be used as a frequency input, one as a frequency output.

The number of digital inputs/outputs can be increased by using FIO-xx I/O extensions.

Settings

Parameter group [14 Digital I/O](#) (page [126](#)).

Programmable relay outputs

The drive has three relay outputs. The signal to be indicated by the outputs can be selected by parameters.

Relay outputs can be added by using FIO-xx I/O extensions.

Settings

Parameter group [14 Digital I/O](#) (page [126](#)).

Programmable protection functions

■ Start interlock (parameter [10.20](#))

The parameter selects how the drive reacts to loss of start interlock signal (DIIL).

■ External fault (parameter [30.01](#))

A source for an external fault signal is selected by this parameter. When the signal is lost, a fault is generated.

■ Local control loss detection (parameter [30.03](#))

The parameter selects how the drive reacts to a control panel or PC tool communication break.

■ Motor phase loss detection (parameter [30.04](#))

The parameter selects how the drive reacts whenever a motor phase loss is detected.

■ Earth fault detection (parameter [30.05](#))

The earth fault detection function is based on sum current measurement. Note that

- an earth fault in the supply cable does not activate the protection
- in a grounded supply, the protection activates in 200 milliseconds
- in an ungrounded supply, the supply capacitance should be 1 microfarad or more
- the capacitive currents caused by shielded motor cables up to 300 metres will not activate the protection
- the protection is deactivated when the drive is stopped.

■ Supply phase loss detection (parameter [30.06](#))

The parameter selects how the drive reacts whenever a supply phase loss is detected.

■ Safe Torque Off detection (parameter [30.07](#))

The drive monitors the status of the Safe Torque Off input. For more information on the Safe Torque Off function, see the *Hardware Manual* of the drive.

■ Switched supply and motor cabling (parameter [30.08](#))

The drive can detect if the supply and motor cables have accidentally been switched (for example, if the supply is connected to the motor connection of the drive). The parameter selects if a fault is generated or not.

■ Stall protection (parameters [30.09...30.12](#))

The drive protects the motor in a stall situation. It is possible to adjust the supervision limits (torque, frequency and time) and choose how the drive reacts to a motor stall condition.

Scalar motor control

It is possible to select scalar control as the motor control method instead of Direct Torque Control (DTC). In scalar control mode, the drive is controlled with a frequency reference. However, the outstanding performance of DTC is not achieved in scalar control.

It is recommended to activate the scalar motor control mode in the following situations:

- In multimotor drives: 1) if the load is not equally shared between the motors, 2) if the motors are of different sizes, or 3) if the motors are going to be changed after motor identification (ID run)
- If the nominal current of the motor is less than 1/6 of the nominal output current of the drive
- If the drive is used without a motor connected (for example, for test purposes)
- If the drive runs a medium-voltage motor through a step-up transformer.

In scalar control, some standard features are not available.

■ IR compensation for a scalar controlled drive

IR compensation is active only when the motor control mode is scalar. When IR compensation is activated, the drive gives an extra voltage boost to the motor at low speeds. IR compensation is useful in applications that require a high break-away torque.

In Direct Torque Control (DTC), no IR compensation is possible or needed.

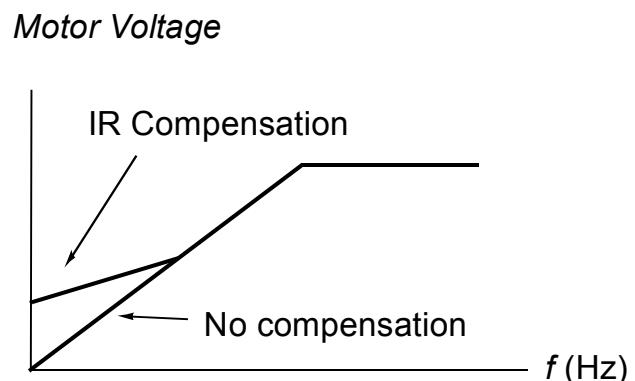

Signal supervision

Three signals can be selected to be supervised by this function. Whenever the signal exceeds (or falls below) a predefined limit, a bit of [06.13 Superv status](#) is activated. Absolute values can be used.

Settings

Parameter group [33 Supervision](#) (page [183](#)).

Speed controller tuning

The speed controller of the drive can be automatically adjusted using the autotune function (parameter [23.20 PI tune mode](#)). Autotuning is based on the load and inertia of the motor and the machine. It is, however, also possible to manually adjust the controller gain, integration time and derivation time.

The figure below shows speed responses at a speed reference step (typically 1...20%).

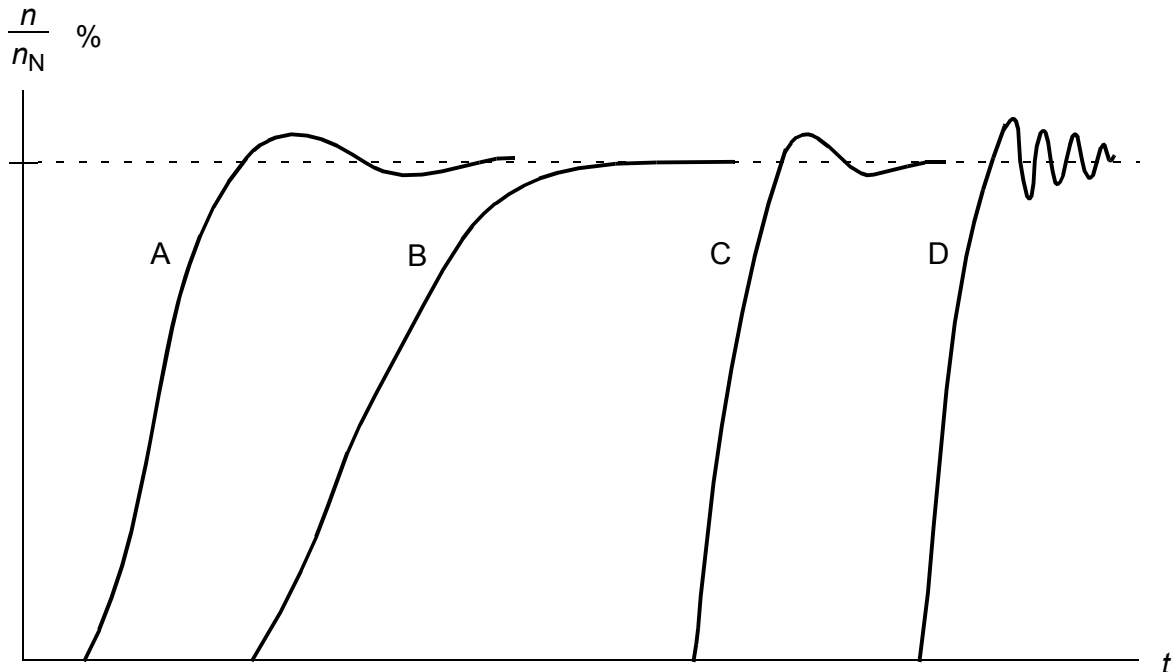

- A: Undercompensated
- B: Normally tuned (autotuning)
- C: Normally tuned (manually). Better dynamic performance than with B
- D: Overcompensated speed controller

The figure below is a simplified block diagram of the speed controller. The controller output is the reference for the torque controller.

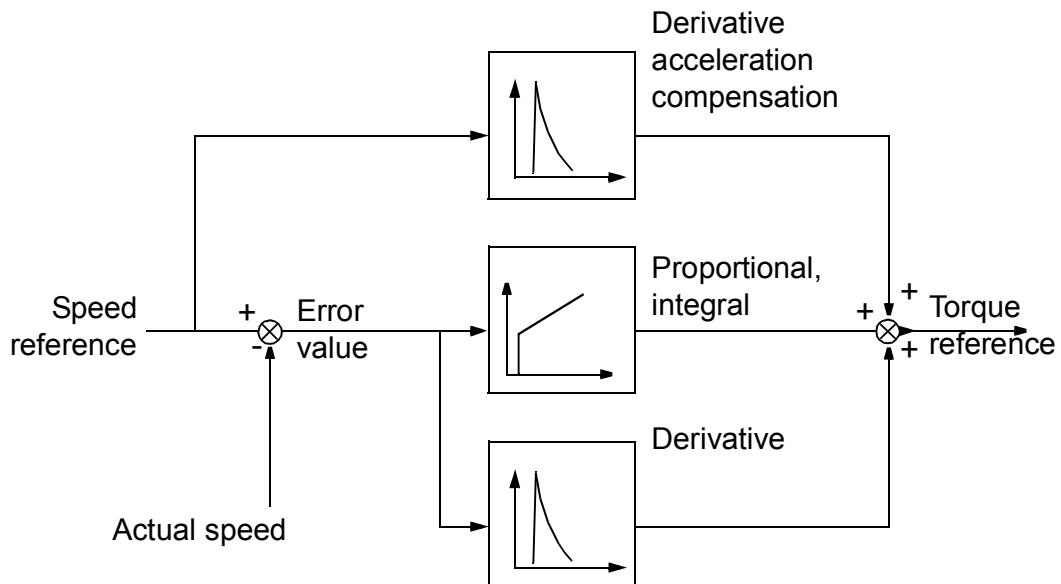

Settings

Parameter group [23 Speed ctrl](#) (page [158](#)).

Thermal motor protection

The motor can be protected against overheating by

- the motor thermal protection model
- measuring the motor temperature with temperature sensors. This will result in a more accurate motor model.

■ Thermal motor protection model

The drive calculates the temperature of the motor on the basis of the following assumptions:

- 1) When power is applied to the drive for the first time, the motor is at ambient temperature (defined by parameter [31.09 Mot ambient temp](#)). After this, when power is applied to the drive, the motor is assumed to be at the estimated temperature.
- 2) Motor temperature is calculated using the user-adjustable motor thermal time and motor load curve. The load curve should be adjusted in case the ambient temperature exceeds 30 °C.

It is possible to adjust the motor temperature supervision limits and select how the drive reacts when overtemperature is detected.

Note: The motor thermal model can be used when only one motor is connected to the inverter.

■ Temperature measurement

It is possible to detect motor overtemperature by connecting a motor temperature sensor between +24 V and digital input DI6 of the drive, or to optional encoder interface module FEN-xx.

Constant current is fed through the sensor. The resistance of the sensor increases as the motor temperature rises over the sensor reference temperature T_{ref} , as does the voltage over the resistor. The temperature measurement function reads the voltage and converts it into ohms.

The figure below shows typical PTC sensor resistance values as a function of the motor operating temperature.

Temperature	PTC resistance
Normal	0... 1.5 kohm
Excessive	≥ 4 kohm

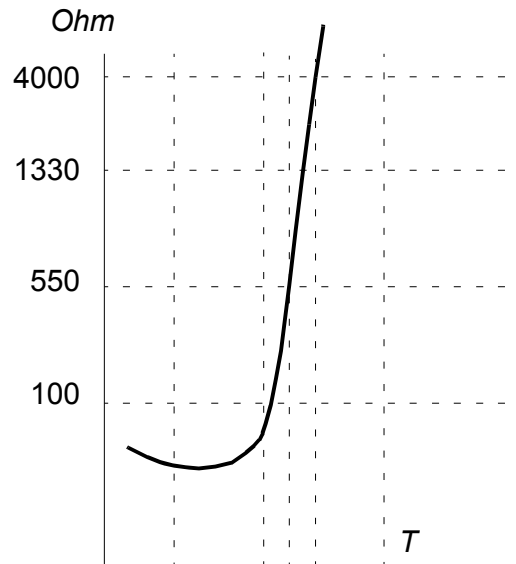

It is possible to adjust the motor temperature supervision limits and select how the drive reacts when overtemperature is detected.

For the wiring of the temperature sensor, refer to the *Hardware Manual* of the drive. For encoder interface module FEN-xx connection, see the *User's Manual* of the encoder interface module.

■ Settings

Parameter group [31 Mot therm prot](#) (page [177](#)).

Timers

It is possible to define four different daily or weekly time periods. The time periods can be used to control four different timers. The on/off statuses of the four timers are indicated by bits 0...3 of parameter [06.14 Timed func stat](#), from where the signal can be connected to any parameter with a bit pointer setting (see page [93](#)). In addition, bit 4 of parameter [06.14](#) is on if any one of the four timers is on.

Each time period can be assigned to multiple timers; likewise, a timer can be controlled by multiple time periods.

The figure below presents how different time periods are active in daily and weekly modes.

Time period 1: Start time 00:00:00; Stop time 00:00:00 or 24:00:00; Start on Tuesday; Stop day Sunday

Time period 2: Start time 03:00:00; Stop time 23:00:00; Start day Wednesday; Stop day Wednesday

Time period 3: Start time 21:00:00; Stop time 03:00:00; Start day Tuesday; Stop day Saturday

Time period 4: Start time 12:00:00; Stop time 00:00:00 or 24:00:00; Start day Thursday; Stop day Tuesday

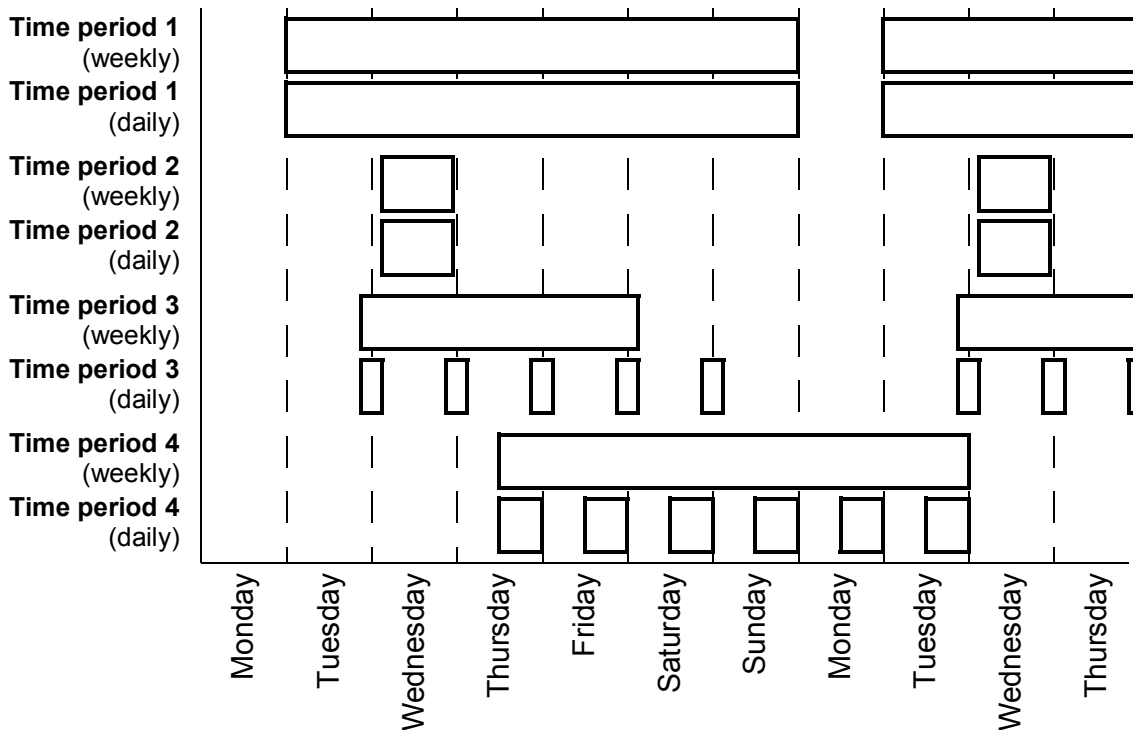

A “boost” function is also available for the activation of the timers: a signal source can be selected to extend the activation time for a parameter-adjustable time period.

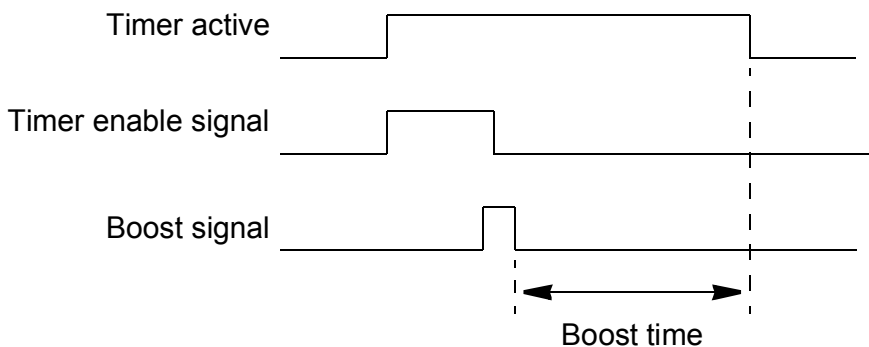

Settings

Parameter group [36 Timed functions](#) (page 194).

User-definable load curve

The drive output can be limited by defining a user-definable load curve. In practice, the user load curve consists of an overload and an underload curve, even though neither is compulsory. Each curve is formed by five points that represent output current or torque as a function of frequency.

An alarm or fault can be set up to occur when the curve is exceeded. The upper boundary (overload curve) can also be used as a torque or current limiter.

Settings

Parameter group [34 User load curve](#) (page [186](#)).

User-definable U/f curve

The user can define a custom U/f curve (output voltage as a function of frequency). The curve can be used in special applications where linear and quadratic U/f ratios are not adequate (e.g. when motor break-away torque needs to be boosted).

Note: Each user-defined point must have a higher frequency and higher voltage than the previous point.



WARNING! High voltage at low frequencies may result in poor performance or motor damage due to overheating.

Settings

Parameter group [38 Flux ref](#) (page [199](#)).



Application macros

What this chapter contains

This chapter describes the intended use, operation and default control connections of the application macros.

More information on the connectivity of the JCU control unit is given in the *Hardware Manual* of the drive.

General

Application macros are pre-defined parameter sets. When starting up the drive, the user typically selects one of the macros as a basis, makes the essential changes and saves the result as a user parameter set.

Application macros are activated through the control panel main menu by selecting ASSISTANTS – Firmware assistants – Application Macro. User parameter sets are managed by the parameters in group [16 System](#) (page [145](#)).

Factory macro

The Factory macro is suited to relatively straightforward speed control applications such as conveyors, pumps and fans, and test benches.

In external control, the control location is EXT1. The drive is speed-controlled; the reference signal is connected to analog input AI1. The sign of the reference determines the running direction. The start/stop commands are given through digital input DI1. Faults are reset through DI3.

The default parameter settings for the Factory macro are listed in chapter [Additional parameter data](#) (page 237).

Default control connections for the Factory macro

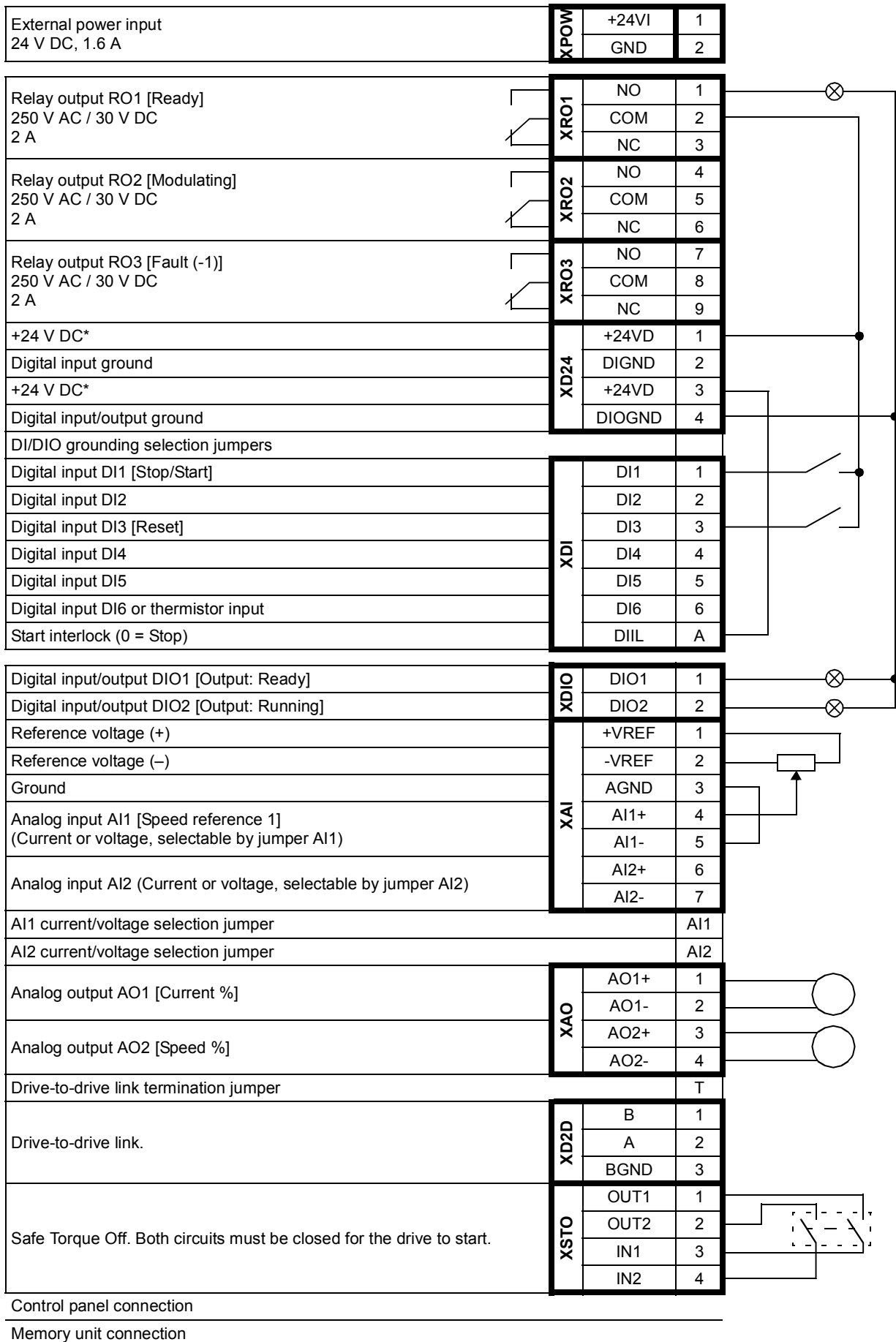

Hand/Auto macro

The Hand/Auto macro is suited for speed control applications where two external control devices are used.

The drive is speed-controlled from the external control locations EXT1 and EXT2. The selection between the control locations is done through digital input DI3.

The start/stop signal for EXT1 is connected to DI1 while running direction is determined by DI2. For EXT2, start/stop commands are given through DI6, the direction through DI5.

The reference signals for EXT1 and EXT2 are connected to analog inputs AI1 and AI2 respectively.

A constant speed (300 rpm) can be activated through DI4.

Default parameter settings for Hand/Auto macro

Below is a listing of default parameter values that differ from those listed in chapter [Additional parameter data](#) (page 237).

Parameter		Hand/Auto macro default
No.	Name	
10.01	<i>Ext1 start func</i>	<i>In1St In2Dir</i>
10.03	<i>Ext1 start in2</i>	<i>DI2</i>
10.04	<i>Ext2 start func</i>	<i>In1St In2Dir</i>
10.05	<i>Ext2 start in1</i>	<i>DI6</i>
10.06	<i>Ext2 start in2</i>	<i>DI5</i>
10.10	<i>Fault reset sel</i>	C.FALSE
12.01	<i>Ext1/Ext2 sel</i>	<i>DI3</i>
13.05	<i>AI1 min scale</i>	0.000
13.09	<i>AI2 max scale</i>	1500.000
13.10	<i>AI2 min scale</i>	0.000
21.02	<i>Speed ref2 sel</i>	<i>AI2 scaled</i>
21.04	<i>Speed ref1/2 sel</i>	<i>DI3</i>
26.02	<i>Const speed sel1</i>	<i>DI4</i>
26.06	<i>Const speed1</i>	300 rpm

Default control connections for the Hand/Auto macro

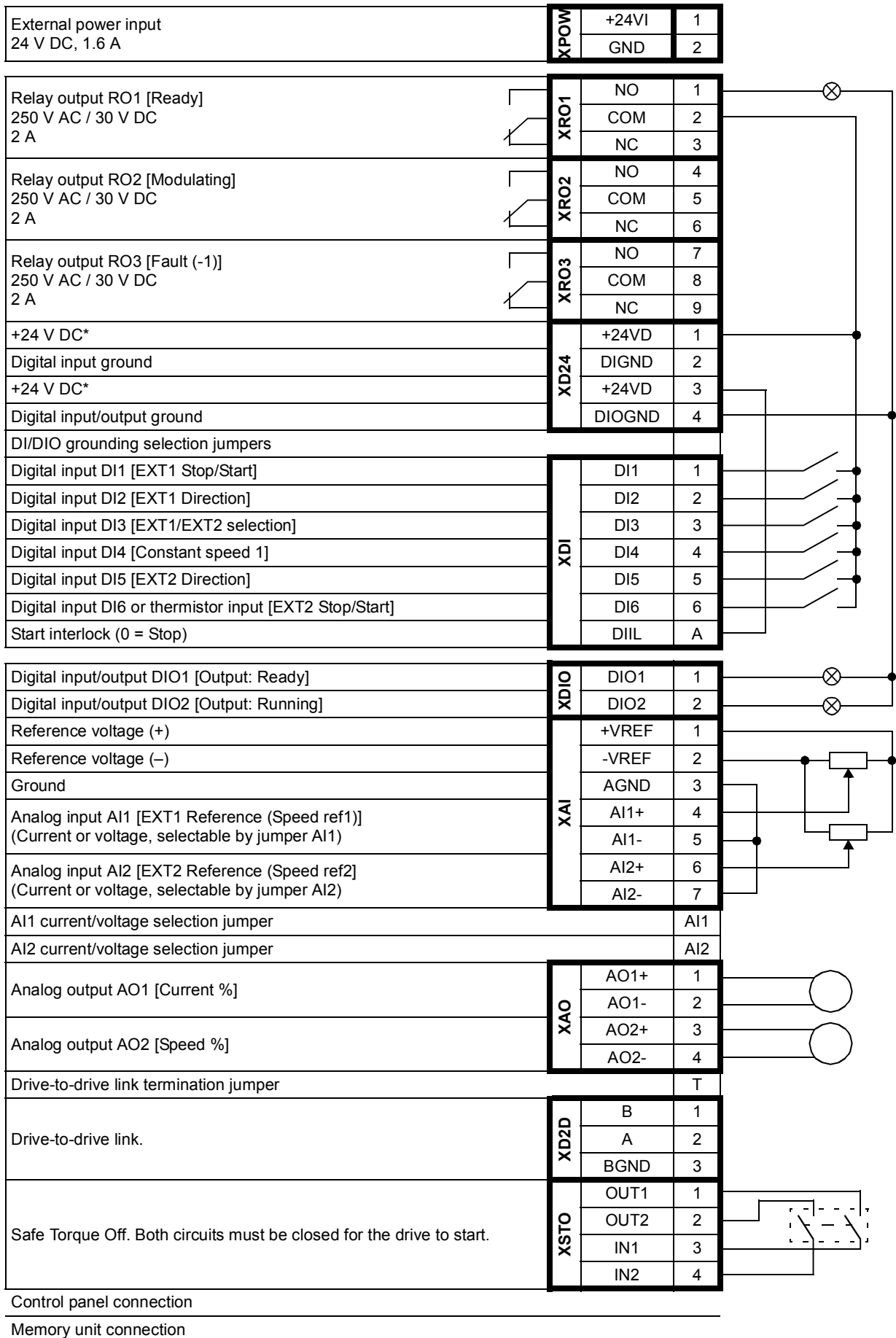

PID control macro

The PID control macro is suitable for process control applications, for example closed-loop pressure, level or flow control systems such as

- pressure boost pumps of municipal water supply systems
- level-controlling pumps of water reservoirs
- pressure boost pumps of district heating systems
- material flow control on a conveyor line.

The process reference signal is connected to analog input AI1 and the process feedback signal to AI2. Alternatively, a direct speed reference can be given to the drive through AI1. Then the PID controller is bypassed and the drive no longer controls the process variable.

Selection between direct speed control (control location EXT1) and process variable control (EXT2) is done through digital input DI3.

The stop/start signals for EXT1 and EXT2 are connected to DI1 and DI6 respectively.

A constant speed (300 rpm) can be activated through DI4.

Default parameter settings for PID control macro

Below is a listing of default parameter values that differ from those listed in chapter [Additional parameter data](#) (page 237).

Parameter		PID control macro default
No.	Name	
10.04	<i>Ext2 start func</i>	<i>In1</i>
10.05	<i>Ext2 start in1</i>	<i>DI6</i>
10.10	<i>Fault reset sel</i>	C.FALSE
12.01	<i>Ext1/Ext2 sel</i>	<i>DI3</i>
13.05	<i>AI1 min scale</i>	0.000
13.09	<i>AI2 max scale</i>	1500.000
13.10	<i>AI2 min scale</i>	0.000
21.02	<i>Speed ref2 sel</i>	<i>PID out</i>
21.04	<i>Speed ref1/2 sel</i>	<i>DI3</i>
26.02	<i>Const speed sel1</i>	<i>DI4</i>
26.06	<i>Const speed1</i>	300 rpm

Default control connections for the PID control macro

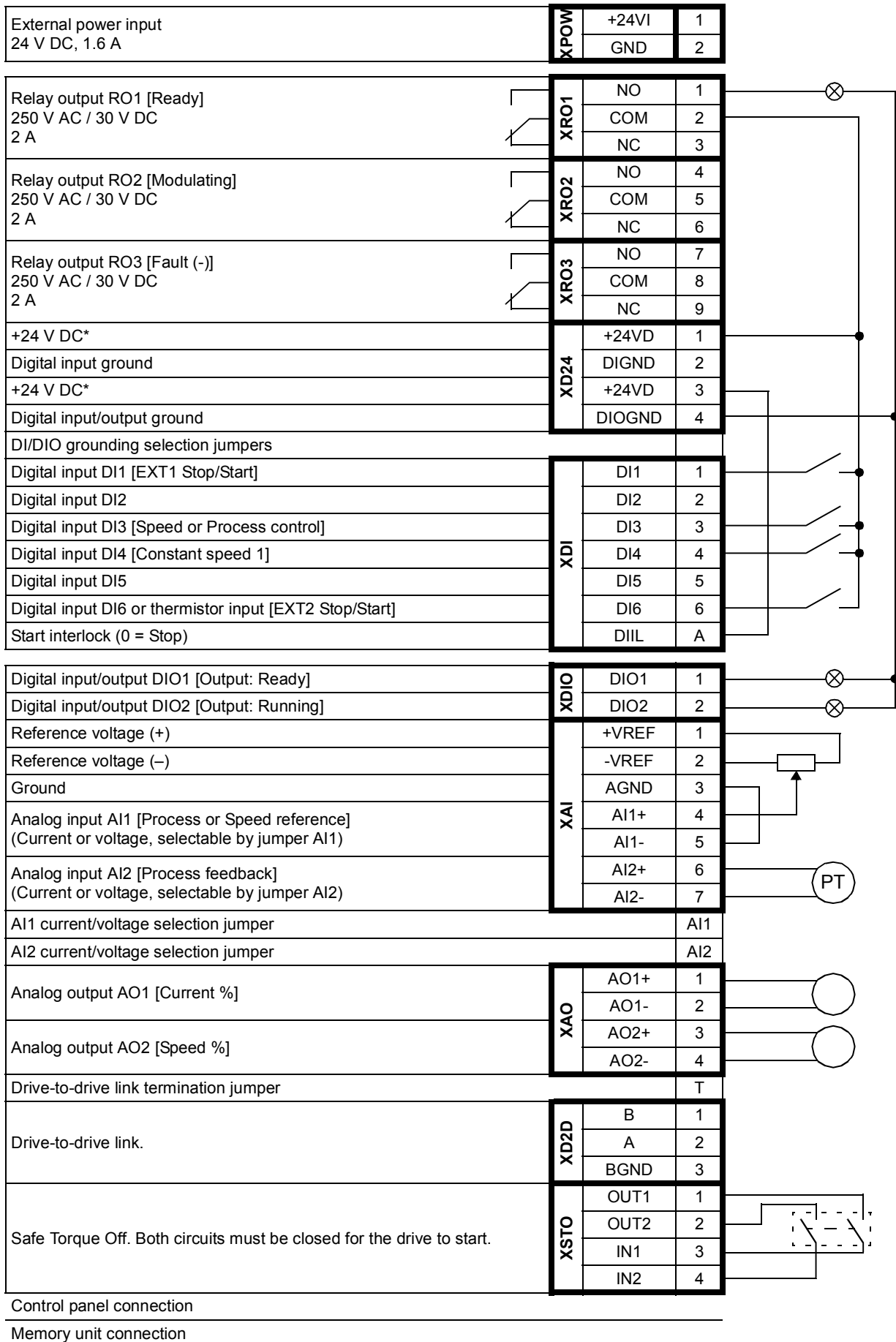

Torque control macro

This macro is used in applications in which torque control of the motor is required. Torque reference is given through analog input AI2, typically as a current signal in the range of 0...20 mA (corresponding to 0...100% of rated motor torque).

The start/stop signal is connected to digital input DI1, direction signal to DI2. Through DI3, it is possible to select speed control instead of torque control.

A constant speed (300 rpm) can be activated through DI4.

Default parameter settings for Torque control macro

Below is a listing of default parameter values that differ from those listed in chapter [Additional parameter data](#) (page 237).

Parameter		Torque control macro default
No.	Name	
10.01	<i>Ext1 start func</i>	<i>In1St In2Dir</i>
10.03	<i>Ext1 start in2</i>	<i>DI2</i>
10.04	<i>Ext2 start func</i>	<i>In1St In2Dir</i>
10.05	<i>Ext2 start in1</i>	<i>DI1</i>
10.06	<i>Ext2 start in2</i>	<i>DI2</i>
10.10	<i>Fault reset sel</i>	C.FALSE
12.01	<i>Ext1/Ext2 sel</i>	<i>DI3</i>
12.05	<i>Ext2 ctrl mode</i>	<i>Torque</i>
13.05	<i>AI1 min scale</i>	0.000
13.10	<i>AI2 min scale</i>	0.000
22.01	<i>Acc/Dec sel</i>	<i>DI5</i>
26.02	<i>Const speed sel1</i>	<i>DI4</i>
26.06	<i>Const speed1</i>	300 rpm

■ Default control connections for the Torque control macro

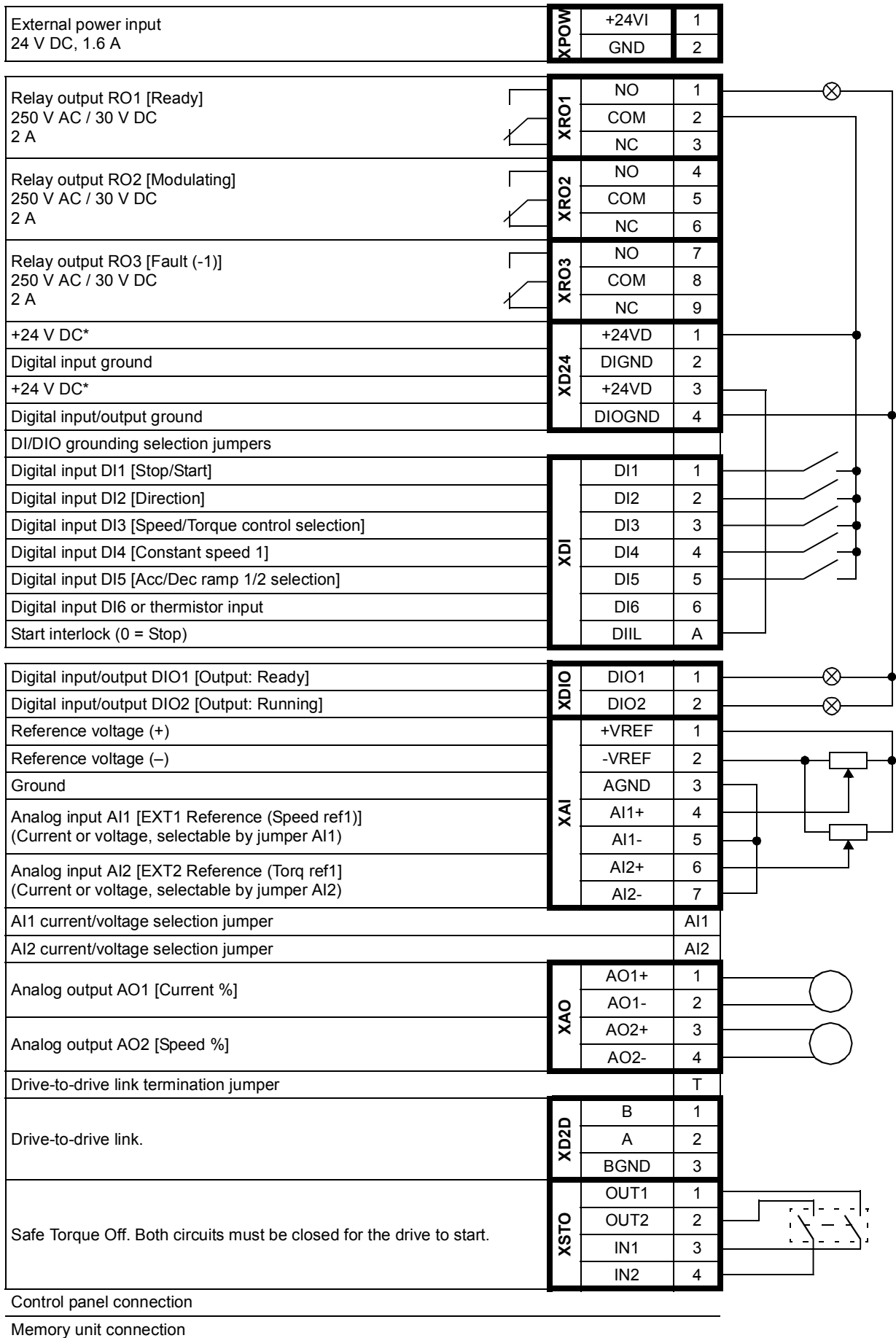

Sequential control macro

The Sequential control macro is suited for speed control applications in which speed reference, multiple constant speeds, and two acceleration and deceleration ramps can be used.

The macro offers seven preset constant speeds which can be activated by digital inputs DI4...DI6 (see parameter [26.01 Const speed func](#)). Two acceleration/ deceleration ramps are selectable through DI3.

An external speed reference can be given through analog input AI1. The reference is active only when no constant speed is activated (all of the digital inputs DI4...DI6 are off). Operational commands can also be given from the control panel.

Operation diagram

The figure below shows an example of the use of the macro.

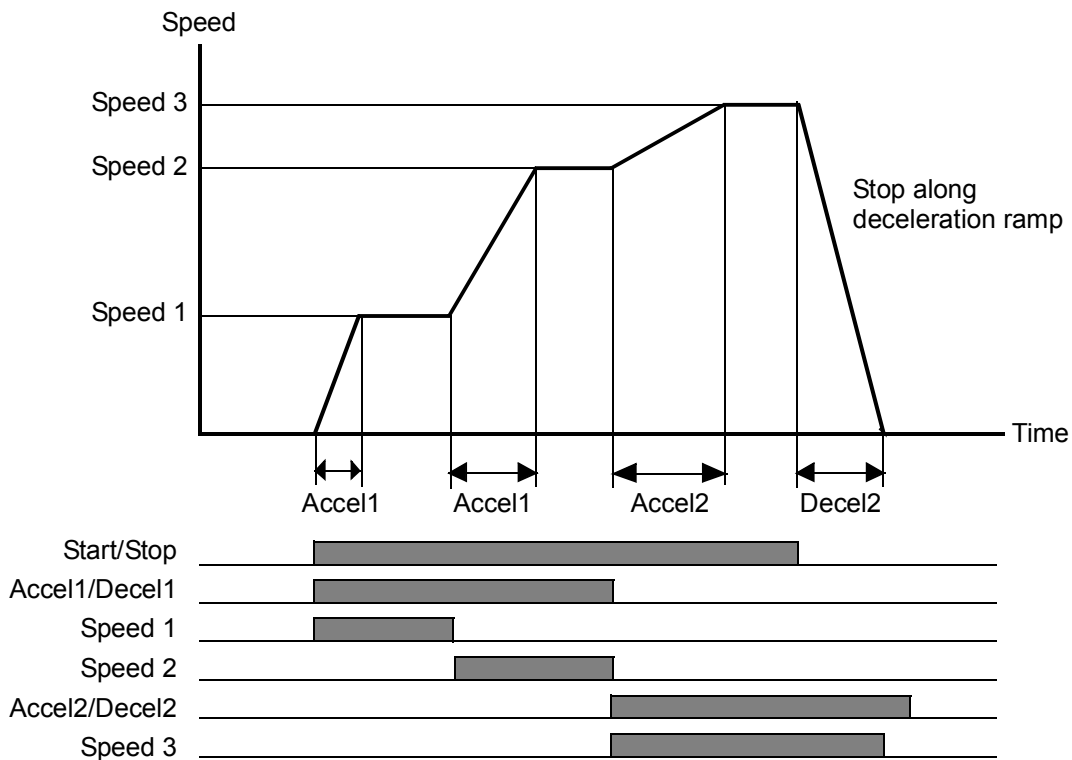

Default parameter settings for Sequential control macro

Below is a listing of default parameter values that differ from those listed in chapter [Additional parameter data](#) (page 237).

Parameter		Sequential control macro default
No.	Name	
10.01	<i>Ext1 start func</i>	<i>In1St In2Dir</i>
10.03	<i>Ext1 start in2</i>	<i>DI2</i>
10.10	<i>Fault reset sel</i>	C.FALSE
11.03	<i>Stop mode</i>	<i>Ramp</i>
13.05	<i>AI1 min scale</i>	0.000
22.01	<i>Acc/Dec sel</i>	<i>DI3</i>
26.01	<i>Const speed func</i>	0b01
26.02	<i>Const speed sel1</i>	<i>DI4</i>
26.03	<i>Const speed sel2</i>	<i>DI5</i>
26.04	<i>Const speed sel3</i>	<i>DI6</i>
26.06	<i>Const speed1</i>	300 rpm
26.07	<i>Const speed2</i>	600 rpm
26.08	<i>Const speed3</i>	900 rpm
26.09	<i>Const speed4</i>	1200 rpm
26.10	<i>Const speed5</i>	1500 rpm
26.11	<i>Const speed6</i>	2400 rpm
26.12	<i>Const speed7</i>	3000 rpm

Default control connections for the Sequential control macro

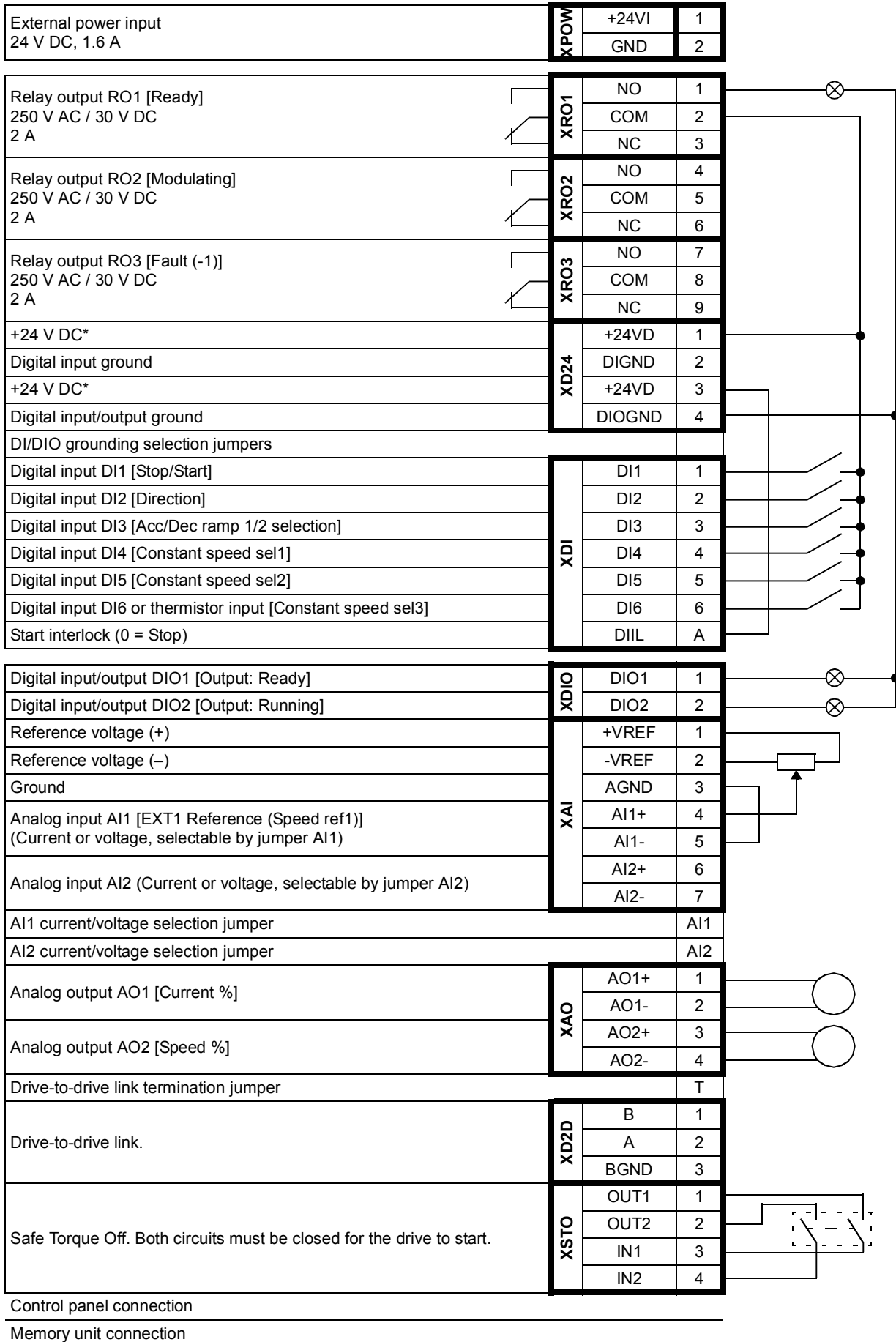



Parameters

What this chapter contains

The chapter describes the parameters, including actual signals, of the control program.

Note: By default, a selective list of parameters is shown by the drive panel or DriveStudio. All parameters can be displayed by setting parameter [16.15 Menu set sel](#) to [Load long](#).

Terms and abbreviations

Term	Definition
Actual signal	Type of parameter that is the result of a measurement or calculation by the drive. Actual signals can be monitored, but not adjusted, by the user. Parameter groups 1...9 typically contain actual signals.
Bit pointer setting	A parameter setting that points to the value of a bit in another parameter (usually an actual signal), or that can be fixed to 0 (FALSE) or 1 (TRUE). When adjusting a bit pointer setting on the optional control panel, "Const" is selected in order to fix the value to 0 (displayed as "C.False") or 1 ("C.True"). "Pointer" is selected to define a source from another parameter. A pointer value is given in the format P.xx.yy.zz , where xx = parameter group, yy = parameter index, zz = bit number. Pointing to a nonexisting bit will be interpreted as 0 (FALSE). In addition to the "Const" and "Pointer" selections, bit pointer settings may also have other pre-selected settings.
FbEq	Fieldbus equivalent. The scaling between the value shown on the panel and the integer used in serial communication.
p.u.	Per unit
Value pointer setting	A parameter value that points to the value of another actual signal or parameter. A pointer value is given in the format P.xx.yy , where xx = parameter group, yy = parameter index.

Parameter listing

No.	Name/Value	Description	FbEq
01 Actual values		Basic signals for monitoring of the drive.	
01.01	Motor speed rpm	Filtered actual speed in rpm. The used speed feedback is defined by parameter 19.02 Speed fb sel . The filter time constant can be adjusted using parameter 19.03 MotorSpeed filt .	100 = 1 rpm
01.02	Motor speed %	Actual speed in percent of the motor synchronous speed.	100 = 1%
01.03	Output frequency	Estimated drive output frequency in Hz.	100 = 1 Hz
01.04	Motor current	Measured motor current in A.	100 = 1 A
01.05	Motor current %	Motor current in percent of the nominal motor current.	10 = 1%
01.06	Motor torque	Motor torque in percent of the nominal motor torque. See also parameter 01.29 Torq nom scale .	10 = 1%
01.07	Dc-voltage	Measured intermediate circuit voltage.	100 = 1 V
01.08	Encoder1 speed	Encoder 1 speed in rpm.	100 = 1 rpm
01.09	Encoder1 pos	Actual position of encoder 1 within one revolution.	100000000 = 1 rev
01.10	Encoder2 speed	Encoder 2 speed in rpm.	100 = 1 rpm
01.11	Encoder2 pos	Actual position of encoder 2 within one revolution.	100000000 = 1 rev
01.12	Pos act	Actual position of encoder 1 in revolutions.	1000 = 1 rev
01.13	Pos 2nd enc	Scaled actual position of encoder 2 in revolutions.	1000 = 1 rev
01.14	Motor speed est	Estimated motor speed in rpm.	100 = 1 rpm
01.15	Temp inverter	Estimated temperature of drive heatsink in percent of fault limit.	10 = 1%
01.16	Temp brk chopper	Brake chopper IGBT temperature in percent of fault limit.	10 = 1%
01.17	Motor temp1	Measured temperature of motor 1 in degrees Celsius.	10 = 1 °C
01.18	Motor temp2	Measured temperature of motor 2 in degrees Celsius.	10 = 1 °C
01.19	Used supply volt	Either the nominal supply voltage defined by parameter 47.04 Supply voltage , or, if auto-identification is enabled by parameter 47.03 SupplyVoltAutold , the automatically determined supply voltage.	10 = 1 V
01.20	Brake res load	Estimated temperature of the braking resistor. The value is given in percent of the temperature the resistor reaches when loaded with the power defined by parameter 48.04 Br power max cnt .	1 = 1%
01.21	Cpu usage	Microprocessor load in percent.	1 = 1%
01.22	Power inu out	Drive output power in kW or hp, depending on setting of parameter 16.17 Power unit .	100 = 1 kW or hp
01.23	Motor power	Measured motor power in kW or hp, depending on setting of parameter 16.17 Power unit .	100 = 1 kW or hp
01.24	kWh inverter	Amount of energy that has passed through the drive (in either direction) in kilowatt-hours.	1 = 1 kWh
01.25	kWh supply	Amount of energy that the drive has taken from the AC supply in kilowatt-hours.	1 = 1 kWh
01.26	On-time counter	On-time counter. The counter runs when the drive is powered. Can be reset using the DriveStudio PC tool.	1 = 1 h

No.	Name/Value	Description	FbEq
01.27	Run-time counter	Motor run-time counter. The counter runs when the inverter modulates. Can be reset using the DriveStudio PC tool.	1 = 1 h
01.28	Fan on-time	Running time of the drive cooling fan. Can be reset by entering 0.	1 = 1 h
01.29	Torq nom scale	Nominal torque which corresponds to 100%. Note: This value is copied from parameter 99.12 Mot nom torque if entered. Otherwise the value is calculated.	1000 = 1 N•m
01.30	Polepairs	Calculated number of pole pairs in the motor.	1 = 1
01.31	Mech time const	Mechanical time constant of the drive and the machinery as determined by the speed controller autotune function. See parameter 23.20 PI tune mode on page 165.	1000 = 1 s
01.32	Temp phase A	Measured temperature of phase U power stage in percent of fault limit.	10 = 1%
01.33	Temp phase B	Measured temperature of phase V power stage in percent of fault limit.	10 = 1%
01.34	Temp phase C	Measured temperature of phase W power stage in percent below fault limit.	10 = 1%
01.35	Saved energy	Energy saved in kWh compared to direct-on-line motor connection. See parameter group 45 Energy optimising on page 211.	1 = 1 kWh
01.36	Saved amount	Monetary savings compared to direct-on-line motor connection. This value is a multiplication of parameters 01.35 Saved energy and 45.02 Energy tariff1 . See parameter group 45 Energy optimising on page 211.	1 = 1
01.37	Saved CO2	Reduction in CO ₂ emissions in metric tons compared to direct-on-line motor connection. This value is calculated by multiplying saved energy in megawatt-hours by 0.5 metric tons/MWh. See parameter group 45 Energy optimising on page 211.	1 = 1 metric ton

02 I/O values		Input and output signals.	
02.01	DI status	Status of digital inputs DI8...DI1. The 7th digit reflects the start interlock input (DIIL). Example: 01000001 = DI1 and DIIL are on, DI2...DI6 and DI8 are off.	-
02.02	RO status	Status of relay outputs RO7...RO1. Example: 0000001 = RO1 is energized, RO2...RO7 are de-energized.	-
02.03	DIO status	Status of digital input/outputs DIO10...DIO1. Example: 0000001001 = DIO1 and DIO4 are on, remainder are off.	-
02.04	AI1	Value of analogue input AI1 in V or mA. Input type is selected with jumper J1 on the JCU Control Unit.	1000 = 1 unit
02.05	AI1 scaled	Scaled value of analogue input AI1. See parameters 13.04 AI1 max scale and 13.05 AI1 min scale .	1000 = 1 unit
02.06	AI2	Value of analogue input AI2 in V or mA. Input type is selected with jumper J2 on the JCU Control Unit.	1000 = 1 unit
02.07	AI2 scaled	Scaled value of analogue input AI2. See parameters 13.09 AI2 max scale and 13.10 AI2 min scale .	1000 = 1 unit
02.08	AI3	Value of analogue input AI3 in V or mA. For input type information, see the extension module manual.	1000 = 1 unit
02.09	AI3 scaled	Scaled value of analogue input AI3. See parameters 13.14 AI3 max scale and 13.15 AI3 min scale .	1000 = 1 unit

96 Parameters

No.	Name/Value	Description	FbEq
02.10	AI4	Value of analogue input AI4 in V or mA. For input type information, see the extension module manual.	1000 = 1 unit
02.11	AI4 scaled	Scaled value of analogue input AI4. See parameters 13.19 AI4 max scale and 13.20 AI4 min scale .	1000 = 1 unit
02.12	AI5	Value of analogue input AI5 in V or mA. For input type information, see the extension module manual.	1000 = 1 unit
02.13	AI5 scaled	Scaled value of analogue input AI5. See parameters 13.24 AI5 max scale and 13.25 AI5 min scale .	1000 = 1 unit
02.14	AI6	Value of analogue input AI6 in V or mA. For input type information, see the extension module manual.	1000 = 1 unit
02.15	AI6 scaled	Scaled value of analogue input AI6. See parameters 13.29 AI6 max scale and 13.30 AI6 min scale .	1000 = 1 unit
02.16	AO1	Value of analogue output AO1 in mA.	1000 = 1 mA
02.17	AO2	Value of analogue output AO2 in mA.	1000 = 1 mA
02.18	AO3	Value of analogue output AO3 in mA.	1000 = 1 mA
02.19	AO4	Value of analogue output AO4 in mA.	1000 = 1 mA
02.20	Freq in	Frequency input value of DIO2 when it is used as a frequency input (parameter 14.06 is set to <i>Freq input</i>).	1000 = 1 Hz
02.21	Freq out	Frequency output value of DIO3 when it is used as a frequency output (parameter 14.10 is set to <i>Freq output</i>).	1000 = 1 Hz

No.	Name/Value	Description	FbEq		
02.22	FBA main cw	Control Word for fieldbus communication. See also chapter Fieldbus control , page 277. Log. = Logical combination (i.e. Bit AND/OR Selection parameter); Par. = Selection parameter.	-		
Bit	Name	Value	Information	Log.	Par.
0*	Stop	1	Stop according to the stop mode selected by par. 11.03 Stop mode or according to the requested stop mode (bits 2...6). Note: Simultaneous stop and start commands result in a stop command.	OR	10.01 , 10.04
		0	No action.		
1	Start	1	Start. Note: Simultaneous stop and start commands result in a stop command.	OR	10.01 , 10.04
		0	No action.		
2*	StpMode em off	1	Emergency OFF2 (bit 0 must be 1). Drive is stopped by cutting off motor power supply (the motor coasts to stop). The drive will restart only with the next rising edge of the start signal when the run enable signal is on.	AND	-
		0	No action.		
3*	StpMode em stop	1	Emergency stop OFF3 (bit 0 must be 1). Stop within time defined by 22.12 Em stop time .	AND	10.13
		0	No action.		
4*	StpMode off1	1	Emergency stop OFF1 (bit 0 must be 1). Stop along the currently active deceleration ramp.	AND	10.15
		0	No action.		
5*	StpMode ramp	1	Stop along the currently active deceleration ramp.	-	11.03
		0	No action.		
6*	StpMode coast	1	Coast to stop.	-	11.03
		0	No action.		
7	Run enable	1	Activate run enable.	AND	10.11
		0	Activate run disable.		
8	Reset	0 -> 1	Fault reset if an active fault exists.	OR	10.10
		other	No action.		
(continued)					
* If all stop mode bits (2...6) are 0, stop mode is selected by parameter 11.03 Stop mode . Coast stop (bit 6) overrides the emergency stop (bits 2/3/4). Emergency stop overrides normal ramp stop (bit 5).					

No.	Name/Value	Description	FbEq			
	Bit	Name	Value	Information	Log.	Par.
	(continued)					
9	Jogging 1	1	Activate Jogging 1. See section Jogging on page 63.	OR	10.07	
		0	Jogging 1 disabled.			
10	Jogging 2	1	Activate Jogging 2. See section Jogging on page 63.	OR	10.08	
		0	Jogging 2 disabled.			
11	Remote cmd	1	Fieldbus control enabled.	-	-	
		0	Fieldbus control disabled.			
12	Ramp out 0	1	Force output of Ramp Function Generator to zero. The drive ramps to a stop (current and DC voltage limits are in force).	-	-	
		0	No action.			
13	Ramp hold	1	Halt ramping (Ramp Function Generator output held).	-	-	
		0	No action.			
14	Ramp in 0	1	Force input of Ramp Function Generator to zero.	-	-	
		0	No action.			
15	Ext1 / Ext2	1	Switch to external control location EXT2.	OR	12.01	
		0	Switch to external control location EXT1.			
16	Req startinh	1	Activate start inhibit.	-	-	
		0	No start inhibit.			
17	Local ctl	1	Request local control for Control Word. Used when the drive is controlled from a PC tool or panel or local fieldbus. <ul style="list-style-type: none"> Local fieldbus: Transfer to fieldbus local control (control through fieldbus Control Word or reference). Fieldbus steals the control. Panel or PC tool: Transfer to local control. 	-	-	
		0	Request external control.			
18	FbLocal ref	1	Request fieldbus local control.	-	-	
		0	No fieldbus local control.			
19...27	Reserved					
28	CW B28	Freely programmable control bits. See parameters 50.08...50.11 and the user manual of the fieldbus adapter.			-	-
29	CW B29					
30	CW B30					
31	CW B31					

No.	Name/Value	Description	FbEq
	Bit	Name	Value Information
	(continued)		
9	Limit	1	Operation is limited by any of the torque limits.
		0	Operation is within the torque limits.
10	Above limit	1	Actual speed exceeds limit defined by parameter 19.08 Above speed lim.
		0	Actual speed is within the defined limits.
11	Ext2 act	1	External control location EXT2 is active.
		0	External control location EXT1 is active.
12	Local fb	1	Fieldbus local control is active.
		0	Fieldbus local control is inactive.
13	Zero speed	1	Drive speed is below limit defined by parameter 19.06 Zero speed limit.
		0	Drive has not reached zero speed limit.
14	Rev act	1	Drive is running in reverse direction.
		0	Drive is running in forward direction.
15	Reserved		
16	Fault	1	A fault is active. See chapter Fault tracing.
		0	No fault is active.
17	Local panel	1	Local control is active, i.e. the drive is controlled from PC tool or control panel.
		0	Local control is inactive.
18...26	Reserved		
27	Request ctl	1	Control Word is requested from fieldbus.
		0	Control Word is not requested from fieldbus.
28	SW B28	Programmable control bits (unless fixed by the used profile). See parameters 50.08...50.11 and the user manual of the fieldbus adapter.	
29	SW B29		
30	SW B30		
31	SW B31		
02.26	FBA main ref1	Scaled fieldbus reference 1. See parameter 50.04 Fba ref1 modesel.	1 = 1
02.27	FBA main ref2	Scaled fieldbus reference 2. See parameter 50.05 Fba ref2 modesel.	1 = 1
02.30	D2D main cw	Drive-to-drive control word received from the master. See also actual signal 02.31 D2D follower cw.	-
	Bit	Information	
	0	Stop.	
	1	Start.	
	2 ... 6	Reserved.	
	7	Run enable. By default, not connected in a follower drive.	
	8	Reset. By default, not connected in a follower drive.	
	9 ... 14	Freely assignable through bit pointer settings.	
	15	EXT1/EXT2 selection. 0 = EXT1 active, 1 = EXT2 active. By default, not connected in a follower drive.	

No.	Name/Value	Description	FbEq																
02.31	D2D follower cw	Drive-to-drive control word sent to the followers by default. See also parameter group 57 D2D communication .	-																
	<table border="1"> <thead> <tr> <th>Bit</th> <th>Information</th> </tr> </thead> <tbody> <tr> <td>0</td> <td>Stop.</td> </tr> <tr> <td>1</td> <td>Start.</td> </tr> <tr> <td>2 ... 6</td> <td>Reserved.</td> </tr> <tr> <td>7</td> <td>Run enable.</td> </tr> <tr> <td>8</td> <td>Reset.</td> </tr> <tr> <td>9 ... 14</td> <td>Freely assignable through bit pointer settings.</td> </tr> <tr> <td>15</td> <td>EXT1/EXT2 selection. 0 = EXT1 active, 1 = EXT2 active.</td> </tr> </tbody> </table>	Bit	Information	0	Stop.	1	Start.	2 ... 6	Reserved.	7	Run enable.	8	Reset.	9 ... 14	Freely assignable through bit pointer settings.	15	EXT1/EXT2 selection. 0 = EXT1 active, 1 = EXT2 active.		
Bit	Information																		
0	Stop.																		
1	Start.																		
2 ... 6	Reserved.																		
7	Run enable.																		
8	Reset.																		
9 ... 14	Freely assignable through bit pointer settings.																		
15	EXT1/EXT2 selection. 0 = EXT1 active, 1 = EXT2 active.																		
02.32	D2D ref1	Drive-to-drive reference 1 received from the master.	1 = 1																
02.33	D2D ref2	Drive-to-drive reference 2 received from the master.	1 = 1																
02.34	Panel ref	Reference given from the control panel.	100 = 1 rpm																
02.35	FEN DI status	Status of the digital inputs of FEN-xx encoder interfaces in drive option slots 1 and 2. Examples: 000001 (01h) = DI1 of FEN-xx in slot 1 is ON, all others are OFF. 000010 (02h) = DI2 of FEN-xx in slot 1 is ON, all others are OFF. 010000 (10h) = DI1 of FEN-xx in slot 2 is ON, all others are OFF. 100000 (20h) = DI2 of FEN-xx in slot 2 is on, all others are OFF.	-																
03 Control values		Speed control, torque control, and other values.																	
03.03	SpeedRef unramp	Used speed reference before ramping and shaping in rpm.	100 = 1 rpm																
03.05	SpeedRef ramped	Ramped and shaped speed reference in rpm.	100 = 1 rpm																
03.06	SpeedRef used	Used speed reference in rpm (reference before speed error calculation).	100 = 1 rpm																
03.07	Speed error filt	Filtered speed error value in rpm.	100 = 1 rpm																
03.08	Acc comp torq	Output of the acceleration compensation (torque in percent).	10 = 1%																
03.09	Torq ref sp ctrl	Limited speed controller output torque in percent.	10 = 1%																
03.11	Torq ref ramped	Ramped torque reference in percent.	10 = 1%																
03.12	Torq ref sp lim	Torque reference limited by the rush control (value in percent). Torque is limited to ensure that the speed is between the minimum and maximum speed limits defined by parameters 20.01 Maximum speed and 20.02 Minimum speed .	10 = 1%																
03.13	Torq ref to TC	Torque reference in percent for the torque control.	10 = 1%																
03.14	Torq ref used	Torque reference after frequency, voltage and torque limiters. 100% corresponds to the motor nominal torque.	10 = 1%																
03.15	Brake torq mem	Torque value (in percent) stored when the mechanical brake close command is issued.	10 = 1%																
03.16	Brake command	Brake on/off command; 0 = close, 1 = open. For brake on/off control, connect this signal to a relay output (or digital output). See section Mechanical brake control on page 66 .	1 = 1																
03.17	Flux ref used	Used flux reference in percent.	1 = 1%																
03.18	Speed ref pot	Output of the motor potentiometer function. (The motor potentiometer is configured using parameters 21.10...21.12 .)	100 = 1 rpm																

102 Parameters

No.	Name/Value	Description	FbEq
04 Appl values		Process and counter values.	
04.01	Process act1	Process feedback 1 for the process PID controller.	100 = 1 unit
04.02	Process act2	Process feedback 2 for the process PID controller.	100 = 1 unit
04.03	Process act	Final process feedback after process feedback selection and modification.	100 = 1 unit
04.04	Process PID err	Process PID error, i.e. difference between PID setpoint and feedback.	10 = 1 unit
04.05	Process PID out	Output of the process PID controller.	10 = 1 unit
04.06	Process var1	Process variable 1. See parameter group 35 Process variable .	1000 = 1
04.07	Process var2	Process variable 2. See parameter group 35 Process variable .	1000 = 1
04.08	Process var3	Process variable 3. See parameter group 35 Process variable .	1000 = 1
04.09	Counter ontime1	Reading of on-time counter 1. See parameter 44.01 Ontime1 func .	1 = 1 s
04.10	Counter ontime2	Reading of on-time counter 2. See parameter group 44.05 Ontime2 func .	1 = 1 s
04.11	Counter edge1	Reading of rising edge counter 1. See parameter group 44.09 Edge count1 func .	1 = 1
04.12	Counter edge2	Reading of rising edge counter 2. See parameter group 44.14 Edge count2 func .	1 = 1
04.13	Counter value1	Reading of value counter 1. See parameter group 44.19 Val count1 func .	1 = 1
04.14	Counter value2	Reading of value counter 2. See parameter group 44.24 Val count2 func .	1 = 1

No.	Name/Value	Description	FbEq
06 Drive status		Drive status words.	
06.01	Status word1	Status word 1 sent to the master.	-
	Bit	Name	Information
	0	Ready	1 = Drive is ready to receive start command. 0 = Drive is not ready.
	1	Enabled	1 = External run enable signal is received. 0 = No external run enable signal is received.
	2	Started	1 = Drive has received start command. 0 = Drive has not received start command.
	3	Running	1 = Drive is modulating. 0 = Drive is not modulating.
	4	Em off (off2)	1 = Emergency OFF2 is active. 0 = Emergency OFF2 is inactive.
	5	Em stop (off3)	1 = Emergency OFF3 (ramp stop) is active. 0 = Emergency OFF3 is inactive.
	6	Ack startinh	1 = Start inhibit is active. 0 = Start inhibit is inactive.
	7	Alarm	1 = Alarm is active. See chapter Fault tracing . 0 = No alarm is active.
	8	Ext2 act	1 = External control EXT2 is active. 0 = External control EXT1 is active.
	9	Local fb	1 = Fieldbus local control is active. 0 = Fieldbus local control is inactive.
	10	Fault	1 = Fault is active. See chapter Fault tracing . 0 = No fault is active.
	11	Local panel	1 = Local control is active, ie. drive is controlled from PC tool or control panel. 0 = Local control is inactive.
	12	Fault(-1)	1 = No fault is active. 0 = Fault is active. See chapter Fault tracing .
	13...31	Reserved	

No.	Name/Value	Description	FbEq
06.02	Status word2	Status word 2 sent to the master.	-
	Bit	Name	Information
	0	Start act	1 = Drive start command is active. 0 = Drive start command is inactive.
	1	Stop act	1 = Drive stop command is active. 0 = Drive stop command is inactive.
	2	Ready relay	1 = Ready to function: run enable signal on, no fault, emergency stop signal off, no ID run inhibition. Connected by default to DIO1 by par. 14.03 DIO1 out src . 0 = Not ready to function.
	3	Modulating	1 = Modulating: IGBTs are controlled, ie. the drive is RUNNING. 0 = No modulation: IGBTs are not controlled.
	4	Ref running	1 = Normal operation is enabled. Running. Drive follows the given reference. 0 = Normal operation is disabled. Drive is not following the given reference (eg. in magnetization phase drive is modulating).
	5	Jogging	1 = Jogging function 1 or 2 is active. 0 = Jogging function is inactive.
	6	Off1	1 = Emergency stop OFF1 is active. 0 = Emergency stop OFF1 is inactive.
	7	Start inh mask	1 = Maskable (by par. 12.01 Start inhibit) start inhibit is active. 0 = No maskable start inhibit is active.
	8	Start inh nomask	1 = Non-maskable start inhibit is active. 0 = No non-maskable start inhibit is active.
	9	Chrg rel closed	1 = Charging relay is closed. 0 = Charging relay is open.
	10	Sto act	1 = Safe Torque Off function is active. See parameter 30.07 Sto diagnostic . 0 = Safe Torque Off function is inactive.
	11	Reserved	
	12	Ramp in 0	1 = Ramp Function Generator input is forced to zero. 0 = Normal operation.
	13	Ramp hold	1 = Ramp Function Generator output is held. 0 = Normal operation.
	14	Ramp out 0	1 = Ramp Function Generator output is forced to zero. 0 = Normal operation.
	15...31	Reserved	

No.	Name/Value	Description	FbEq
06.03	Speed ctrl stat	Speed control status word.	-
	Bit	Name	Information
	0	Speed act neg	1 = Actual speed is negative.
	1	Zero speed	1 = Actual speed has reached the zero speed limit (parameters 19.06 Zero speed limit and 19.07 Zero speed delay).
	2	Above limit	1 = Actual speed has exceeded the supervision limit (parameter 19.08 Above speed lim).
	3	At setpoint	1 = The difference between the actual speed and the unramped speed reference is within the speed window (parameter 19.10 Speed window).
	4	Reserved	
	5	PI tune active	1 = Speed controller autotune is active.
	6	PI tune request	1 = Speed controller autotune has been requested by parameter 23.20 PI tune mode .
	7	PI tune done	1 = Speed controller autotune has been completed successfully.
	8...15	Reserved	
06.05	Limit word1	Limit word 1.	-
	Bit	Name	Information
	0	Torq lim	1 = Drive torque is being limited by the motor control (undervoltage control, current control, load angle control or pull-out control), or by the torque limit parameters in group 20 Limits .
	1	Spd ctl tlim min	1 = Speed controller output minimum torque limit is active. The limit is defined by parameter 23.10 Min torq sp ctrl .
	2	Spd ctl tlim max	1 = Speed controller output maximum torque limit is active. The limit is defined by parameter 23.09 Max torq sp ctrl .
	3	Torq ref max	1 = Torque reference (03.11 Torq ref ramped) maximum limit is active. The limit is defined by parameter 24.03 Maximum torq ref .
	4	Torq ref min	1 = Torque reference (03.11 Torq ref ramped) minimum limit is active. The limit is defined by parameter 24.04 Minimum torq ref .
	5	Tlim max speed	1 = Torque reference maximum value is limited by the rush control, because of maximum speed limit 20.01 Maximum speed .
	6	Tlim min speed	1 = Torque reference minimum value is limited by the rush control, because of minimum speed limit 20.02 Minimum speed .
	7	Reserved	

No.	Name/Value	Description	FbEq
06.07	Torq lim status	Torque controller limitation status word.	-
	Bit	Name	Information
	0	Undervoltage	1 = Intermediate circuit DC undervoltage. *
	1	Overvoltage	1 = Intermediate circuit DC overvoltage. *
	2	Minimum torque	1 = Torque reference minimum limit is active. The limit is defined by parameter 24.04 Minimum torq ref. *
	3	Maximum torque	1 = Torque reference maximum limit is active. The limit is defined by parameter 24.03 Maximum torq ref. *
	4	Internal current	1 = An inverter current limit is active. The limit is identified by bits 8...11.
	5	Load angle	1 = For permanent magnet motor only: Load angle limit is active, i.e. the motor cannot produce more torque.
	6	Motor pull-out	1 = For asynchronous motor only: Motor pull-out limit is active, i.e. the motor cannot produce more torque.
	7	Reserved	
	8	Thermal	1 = Input current is limited by main circuit thermal limit.
	9	Max current	1 = Inverter maximum output current limit is active (limits the drive output current I_{MAX}). **
	10	User current	1 = Maximum inverter output current limit is active. The limit is defined by parameter 20.05 Maximum current. **
	11	Thermal IGBT	1 = Calculated thermal current value limits the inverter output current. **
	* One of bits 0...3 can be on simultaneously. The bit typically indicates the limit that is exceeded first.		
	** Only one of bits 9...11 can be on simultaneously. The bit typically indicates the limit that is exceeded first.		
06.12	Op mode ack	Operation mode acknowledge: 0 = Stopped, 1 = Speed, 2 = Torque, 3 = Min, 4 = Max, 5 = Add, 10 = Scalar, 11 = Forced Magn (i.e. DC Hold)	1 = 1
06.13	Superv status	Supervision status word. Bits 0...2 reflect the status of supervisory functions 1...3 respectively. The functions are configured in parameter group 33 Supervision (page 183).	-
06.14	Timed func stat	Bits 0...3 show the on/off status of the four timers (1...4 respectively) configured in parameter group 36 Timed functions . Bit 4 is on if any one of the four timers is on.	-
06.15	Counter status	Counter status word. Shows whether the maintenance counters configured in parameter group 44 Maintenance have exceeded their limits.	-
	Bit	Name	Information
	0	Ontime1	1 = On-time counter 1 has reached its preset limit.
	1	Ontime2	1 = On-time counter 2 has reached its preset limit.
	2	Edge1	1 = Rising edge counter 1 has reached its preset limit.
	3	Edge2	1 = Rising edge counter 2 has reached its preset limit.
	4	Value1	1 = Value counter 1 has reached its preset limit.
	5	Value2	1 = Value counter 2 has reached its preset limit.
08 Alarms & faults		Alarm and fault information.	
08.01	Active fault	Fault code of the latest fault.	1 = 1
08.02	Last fault	Fault code of the 2nd latest fault.	1 = 1

No.	Name/Value	Description	FbEq
08.03	Fault time hi	Time (real time or power-on time) at which the active fault occurred in format dd.mm.yy (day, month and year).	1 = 1 d
08.04	Fault time lo	Time (real time or power-on time) at which the active fault occurred in format hh.mm.ss (hours, minutes and seconds).	1 = 1
08.05	Alarm word1	Alarm word 1. For possible causes and remedies, see chapter Fault tracing .	-
	Bit	Name	
	0	Brake start torq	
	1	Brake not closed	
	2	Brake not open	
	3	Safe torq off	
	4	Sto mode	
	5	Motor temp1	
	6	Em off	
	7	Run enable	
	8	Id run	
	9	Em stop	
	10	Position scaling	
	11	Br overtemp	
	12	BC igbt overtemp	
	13	Device overtemp	
	14	Int board ovtemp	
	15	BC mod overtemp	
08.06	Alarm word2	Alarm word 2. For possible causes and remedies, see chapter Fault tracing .	-
	Bit	Name	
	0	Inu overtemp	
	1	FBA comm	
	2	Panel loss	
	3	AI supervision	
	4	FBA par conf	
	5	No motor data	
	6	Encoder1	
	7	Encoder2	
	8	Latch pos1	
	9	Latch pos2	
	10	Enc emul	
	11	FEN temp meas	
	12	Emul max freq	
	13	Emul pos ref	
	14	Resolver atune	
	15	Enc1 cable	

No.	Name/Value	Description	FbEq
08.07	Alarm word3	Alarm word 3. For possible causes and remedies, see chapter Fault tracing .	-
	Bit	Name	
	0	Enc2 cable	
	1	D2D comm	
	2	D2D buffer ol	
	3	PS comm	
	4	Restore	
	5	Curr meas calib	
	6	Autophasing	
	7	Earthfault	
	8	Autoreset	
	9	Motor nom value	
	10	D2D config	
	11	Stall	
	12	Load curve	
	13	Load curve conf	
	14	U/f curve conf	
	15	Speed meas	
08.08	Alarm word4	Alarm word 4. For possible causes and remedies, see chapter Fault tracing .	-
	Bit	Name	
	0	Option comm loss	
	1	Solution prog	
	2	Motor temp2	

09 System info		Drive type, program revision and option slot occupation information.	
09.01	Drive type	Displays the drive type (for example, ACS850).	-
09.02	Drive rating ID	Displays the inverter type (ACS850-xx-...) of the drive. 0 = Unconfigured, 101 = 03A0, 102 = 03A6, 103 = 04A8, 104 = 06A0, 105 = 08A0, 106 = 010A, 107 = 014A, 108 = 018A, 109 = 025A, 110 = 030A, 111 = 035A, 112 = 044A, 113 = 050A, 114 = 061A, 115 = 078A, 116 = 094A, 117 = 103A, 118 = 144A, 119 = 166A, 120 = 202A, 121 = 225A, 122 = 260A, 123 = 290A, 124 = 430A, 125 = 521A, 126 = 602A, 127 = 693A, 128 = 720A	1 = 1
09.03	Firmware ID	Displays the firmware name. E.g. UIF1.	-
09.04	Firmware ver	Displays the version of the firmware package in the drive, e.g. E00F hex.	-
09.05	Firmware patch	Displays the version of the firmware patch in the drive.	1 = 1
09.10	Int logic ver	Displays the version of the logic on the main circuit board of the drive.	-

No.	Name/Value	Description	FbEq															
09.20	Option slot1	Displays the type of the optional module in option slot 1. 0 = No option, 1 = No comm, 2 = Unknown, 3 = FEN-01, 4 = FEN-11, 5 = FEN-21, 6 = FIO-01, 7 = FIO-11, 8 = FPBA-01, 9 = FPBA-02, 10 = FCAN-01, 11 = FDNA-01, 12 = FENA-01, 13 = FENA-02, 14 = FLON-01, 15 = FRSA-00, 16 = FMBA-01, 17 = FFOA-01, 18 = FFOA-02, 19 = FSEN-01, 20 = FEN-31, 21 = FIO-21, 22 = FSCA-01, 23 = FSEA-21	1 = 1															
09.21	Option slot2	Displays the type of the optional module in option slot 2. See signal 09.20 Option slot1 .	1 = 1															
09.22	Option slot3	Displays the type of the optional module in option slot 3. See signal 09.20 Option slot1 .	1 = 1															
10 Start/stop		Start/stop/direction etc. signal source selections.																
10.01	Ext1 start func	Selects the source of start and stop commands for external control location 1 (EXT1). Note: This parameter cannot be changed while the drive is running.																
	Not sel	No start or stop command sources selected.	0															
	In1	The source of the start and stop commands is selected by parameter 10.02 Ext1 start in1 . The state transitions of the source bit are interpreted as follows: <table border="1" data-bbox="545 1019 995 1153"> <thead> <tr> <th>State of source (via par 10.02)</th> <th>Command</th> </tr> </thead> <tbody> <tr> <td>0 -> 1</td> <td>Start</td> </tr> <tr> <td>1 -> 0</td> <td>Stop</td> </tr> </tbody> </table>	State of source (via par 10.02)	Command	0 -> 1	Start	1 -> 0	Stop	1									
State of source (via par 10.02)	Command																	
0 -> 1	Start																	
1 -> 0	Stop																	
	3-wire	The sources of the start and stop commands is selected by parameters 10.02 Ext1 start in1 and 10.03 Ext1 start in2 . The state transitions of the source bits are interpreted as follows: <table border="1" data-bbox="545 1310 1262 1478"> <thead> <tr> <th>State of source 1 (via par. 10.02)</th> <th>State of source 2 (via par. 10.03)</th> <th>Command</th> </tr> </thead> <tbody> <tr> <td>0 -> 1</td> <td>1</td> <td>Start</td> </tr> <tr> <td>Any</td> <td>1 -> 0</td> <td>Stop</td> </tr> <tr> <td>Any</td> <td>0</td> <td>Stop</td> </tr> </tbody> </table>	State of source 1 (via par. 10.02)	State of source 2 (via par. 10.03)	Command	0 -> 1	1	Start	Any	1 -> 0	Stop	Any	0	Stop	2			
State of source 1 (via par. 10.02)	State of source 2 (via par. 10.03)	Command																
0 -> 1	1	Start																
Any	1 -> 0	Stop																
Any	0	Stop																
	FBA	The start and stop commands are taken from the fieldbus.	3															
	D2D	The start and stop commands are taken from another drive through the D2D (Drive-to-drive) Control Word.	4															
	In1F In2R	The source selected by 10.02 Ext1 start in1 is the forward start signal, the source selected by 10.03 Ext1 start in2 is the reverse start signal. <table border="1" data-bbox="545 1758 1262 1960"> <thead> <tr> <th>State of source 1 (via par. 10.02)</th> <th>State of source 2 (via par. 10.03)</th> <th>Command</th> </tr> </thead> <tbody> <tr> <td>0</td> <td>0</td> <td>Stop</td> </tr> <tr> <td>1</td> <td>0</td> <td>Start forward</td> </tr> <tr> <td>0</td> <td>1</td> <td>Start reverse</td> </tr> <tr> <td>1</td> <td>1</td> <td>Stop</td> </tr> </tbody> </table>	State of source 1 (via par. 10.02)	State of source 2 (via par. 10.03)	Command	0	0	Stop	1	0	Start forward	0	1	Start reverse	1	1	Stop	5
State of source 1 (via par. 10.02)	State of source 2 (via par. 10.03)	Command																
0	0	Stop																
1	0	Start forward																
0	1	Start reverse																
1	1	Stop																
	In1St In2Dir	The source selected by 10.02 Ext1 start in1 is the start signal (0 = stop, 1 = start), the source selected by 10.03 Ext1 start in2 is the direction signal (0 = forward, 1 = reverse).	6															

110 Parameters

No.	Name/Value	Description	FbEq												
10.02	Ext1 start in1	Selects source 1 of start and stop commands for external control location EXT1. See parameter 10.01 Ext1 start func , selections In1 and 3-wire . Note: This parameter cannot be changed while the drive is running.													
	DI1	Digital input DI1 (as indicated by 02.01 DI status , bit 0).	1073742337												
	DI6	Digital input DI6 (as indicated by 02.01 DI status , bit 5).	1074070017												
	DIO4	Digital input/output DIO4 (as indicated by 02.03 DIO status , bit 3).	1073938947												
	Timed func	Bit 4 of parameter 06.14 Timed func stat . The bit is on when at least one of the four timers configured in parameter group 36 Timed functions is on.	1074005518												
	Const	Constant and bit pointer settings (see Terms and abbreviations on page 93).	-												
	Pointer														
10.03	Ext1 start in2	Selects source 2 of start and stop commands for external control location EXT1. See parameter 10.01 Ext1 start func , selection 3-wire . Note: This parameter cannot be changed while the drive is running.													
	DI2	Digital input DI2 (as indicated by 02.01 DI status , bit 1).	1073807873												
	DI5	Digital input DI5 (as indicated by 02.01 DI status , bit 4).	1074004481												
	DIO5	Digital input/output DIO5 (as indicated by 02.03 DIO status , bit 4).	1074004483												
	Const	Bit pointer setting (see Terms and abbreviations on page 93).	-												
	Pointer														
10.04	Ext2 start func	Selects the source of start and stop commands for external control location 2 (EXT2). Note: This parameter cannot be changed while the drive is running.													
	Not sel	No start or stop command sources selected.	0												
	In1	The source of the start and stop commands is selected by parameter 10.05 Ext2 start in1 . The state transitions of the source bit are interpreted as follows: <table border="1" data-bbox="475 1496 921 1630"> <thead> <tr> <th>State of source (via par 10.05)</th> <th>Command</th> </tr> </thead> <tbody> <tr> <td>0 -> 1</td> <td>Start</td> </tr> <tr> <td>1 -> 0</td> <td>Stop</td> </tr> </tbody> </table>	State of source (via par 10.05)	Command	0 -> 1	Start	1 -> 0	Stop	1						
State of source (via par 10.05)	Command														
0 -> 1	Start														
1 -> 0	Stop														
	3-wire	The sources of the start and stop commands is selected by parameters 10.05 Ext2 start in1 and 10.06 Ext2 start in2 . The state transitions of the source bits are interpreted as follows: <table border="1" data-bbox="475 1787 1188 1955"> <thead> <tr> <th>State of source 1 (via par. 10.05)</th> <th>State of source 2 (via par. 10.06)</th> <th>Command</th> </tr> </thead> <tbody> <tr> <td>0 -> 1</td> <td>1</td> <td>Start</td> </tr> <tr> <td>Any</td> <td>1 -> 0</td> <td>Stop</td> </tr> <tr> <td>Any</td> <td>0</td> <td>Stop</td> </tr> </tbody> </table>	State of source 1 (via par. 10.05)	State of source 2 (via par. 10.06)	Command	0 -> 1	1	Start	Any	1 -> 0	Stop	Any	0	Stop	2
State of source 1 (via par. 10.05)	State of source 2 (via par. 10.06)	Command													
0 -> 1	1	Start													
Any	1 -> 0	Stop													
Any	0	Stop													
	FBA	The start and stop commands are taken from the fieldbus.	3												

No.	Name/Value	Description	FbEq															
	D2D	The start and stop commands are taken from another drive through the D2D (Drive-to-drive) Control Word.	4															
	In1F In2R	<p>The source selected by 10.05 Ext2 start in1 is the forward start signal, the source selected by 10.06 Ext2 start in2 is the reverse start signal.</p> <table border="1"> <thead> <tr> <th>State of source 1 (via par. 10.05)</th> <th>State of source 2 (via par. 10.06)</th> <th>Command</th> </tr> </thead> <tbody> <tr> <td>0</td> <td>0</td> <td>Stop</td> </tr> <tr> <td>1</td> <td>0</td> <td>Start forward</td> </tr> <tr> <td>0</td> <td>1</td> <td>Start reverse</td> </tr> <tr> <td>1</td> <td>1</td> <td>Stop</td> </tr> </tbody> </table>	State of source 1 (via par. 10.05)	State of source 2 (via par. 10.06)	Command	0	0	Stop	1	0	Start forward	0	1	Start reverse	1	1	Stop	5
State of source 1 (via par. 10.05)	State of source 2 (via par. 10.06)	Command																
0	0	Stop																
1	0	Start forward																
0	1	Start reverse																
1	1	Stop																
	In1St In2Dir	The source selected by 10.05 Ext2 start in1 is the start signal (0 = stop, 1 = start), the source selected by 10.06 Ext2 start in2 is the direction signal (0 = forward, 1 = reverse).	6															
10.05	Ext2 start in1	<p>Selects source 1 of start and stop commands for external control location EXT2. See parameter 10.04 Ext2 start func, selections In1 and 3-wire.</p> <p>Note: This parameter cannot be changed while the drive is running.</p>																
	DI1	Digital input DI1 (as indicated by 02.01 DI status , bit 0).	1073742337															
	DI6	Digital input DI6 (as indicated by 02.01 DI status , bit 5).	1074070017															
	DIO4	Digital input/output DIO4 (as indicated by 02.03 DIO status , bit 3).	1073938947															
	Timed func	Bit 4 of parameter 06.14 Timed func stat . The bit is on when any one of the four timers configured in parameter group 36 Timed functions is on.	1074005518															
	Const	Bit pointer setting (see Terms and abbreviations on page 93).	-															
	Pointer																	
10.06	Ext2 start in2	<p>Selects source 2 of start and stop commands for external control location EXT2. See parameter 10.04 Ext2 start func, selection 3-wire.</p> <p>Note: This parameter cannot be changed while the drive is running.</p>																
	DI2	Digital input DI2 (as indicated by 02.01 DI status , bit 1).	1073807873															
	DI5	Digital input DI5 (as indicated by 02.01 DI status , bit 4).	1074004481															
	DIO5	Digital input/output DIO5 (as indicated by 02.03 DIO status , bit 4).	1074004483															
	Const	Bit pointer setting (see Terms and abbreviations on page 93).	-															
	Pointer																	

112 Parameters

No.	Name/Value	Description	FbEq
10.07	Jog1 start	<p>If enabled by parameter 10.09 Jog enable, selects the source for the activation of jogging function 1. (Jogging function 1 can also be activated through fieldbus regardless of parameter 10.09.)</p> <p>1 = Active.</p> <p>See also other jogging function parameters: 10.08 Jog2 start, 10.09 Jog enable, 21.07 Speed ref jog1, 21.08 Speed ref jog2, 22.10 Acc time jogging, 22.11 Dec time jogging and 19.07 Zero speed delay.</p> <p>Note: This parameter cannot be changed while the drive is running.</p>	
	DI3	Digital input DI3 (as indicated by 02.01 DI status , bit 2).	1073873409
	DI4	Digital input DI4 (as indicated by 02.01 DI status , bit 3).	1073938945
	DI5	Digital input DI5 (as indicated by 02.01 DI status , bit 4).	1074004481
	DI6	Digital input DI6 (as indicated by 02.01 DI status , bit 5).	1074070017
	DIO4	Digital input/output DIO4 (as indicated by 02.03 DIO status , bit 3).	1073938947
	DIO5	Digital input/output DIO5 (as indicated by 02.03 DIO status , bit 4).	1074004483
	Const	Bit pointer setting (see Terms and abbreviations on page 93).	-
	Pointer		
10.08	Jog2 start	<p>If enabled by parameter 10.09 Jog enable, selects the source for the activation of jogging function 2. (Jogging function 2 can also be activated through fieldbus regardless of parameter 10.09.)</p> <p>1 = Active.</p> <p>See also parameter 10.07 Jog1 start.</p> <p>Note: This parameter cannot be changed while the drive is running.</p>	
	DI3	Digital input DI3 (as indicated by 02.01 DI status , bit 2).	1073873409
	DI4	Digital input DI4 (as indicated by 02.01 DI status , bit 3).	1073938945
	DI5	Digital input DI5 (as indicated by 02.01 DI status , bit 4).	1074004481
	DI6	Digital input DI6 (as indicated by 02.01 DI status , bit 5).	1074070017
	DIO4	Digital input/output DIO4 (as indicated by 02.03 DIO status , bit 3).	1073938947
	DIO5	Digital input/output DIO5 (as indicated by 02.03 DIO status , bit 4).	1074004483
	Const	Bit pointer setting (see Terms and abbreviations on page 93).	-
	Pointer		
10.09	Jog enable	<p>Selects the source for enabling parameters 10.07 Jog1 start and 10.08 Jog2 start.</p> <p>Note: Jogging can be enabled using this parameter only when no start command from an external control location is active. On the other hand, if jogging is already enabled, the drive cannot be started from an external control location apart from jog commands through fieldbus.</p>	
	DI3	Digital input DI3 (as indicated by 02.01 DI status , bit 2).	1073873409
	DI4	Digital input DI4 (as indicated by 02.01 DI status , bit 3).	1073938945
	DI5	Digital input DI5 (as indicated by 02.01 DI status , bit 4).	1074004481

No.	Name/Value	Description	FbEq
	D16	Digital input DI6 (as indicated by 02.01 DI status , bit 5).	1074070017
	DIO4	Digital input/output DIO4 (as indicated by 02.03 DIO status , bit 3).	1073938947
	DIO5	Digital input/output DIO5 (as indicated by 02.03 DIO status , bit 4).	1074004483
	DIO6	Digital input/output DIO6 (as indicated by 02.03 DIO status , bit 5).	1074070019
	Const	Bit pointer setting (see Terms and abbreviations on page 93).	-
	Pointer		
10.10	Fault reset sel	Selects the source of the external fault reset signal. The signal resets the drive after a fault trip if the cause of the fault no longer exists. 0 -> 1 = Fault reset. Note: A fault reset from the fieldbus is always observed regardless of this setting.	
	D11	Digital input DI1 (as indicated by 02.01 DI status , bit 0).	1073742337
	D12	Digital input DI2 (as indicated by 02.01 DI status , bit 1).	1073807873
	D13	Digital input DI3 (as indicated by 02.01 DI status , bit 2).	1073873409
	D14	Digital input DI4 (as indicated by 02.01 DI status , bit 3).	1073938945
	D15	Digital input DI5 (as indicated by 02.01 DI status , bit 4).	1074004481
	D16	Digital input DI6 (as indicated by 02.01 DI status , bit 5).	1074070017
	DIO4	Digital input/output DIO4 (as indicated by 02.03 DIO status , bit 3).	1073938947
	DIO5	Digital input/output DIO5 (as indicated by 02.03 DIO status , bit 4).	1074004483
	DIO6	Digital input/output DIO6 (as indicated by 02.03 DIO status , bit 5).	1074070019
	Const	Bit pointer setting (see Terms and abbreviations on page 93).	-
	Pointer		
10.11	Run enable	Selects the source of the external run enable signal. If the run enable signal is switched off, the drive will not start, or coasts to stop if running. 1 = Run enable. Note: This parameter cannot be changed while the drive is running.	
	D11	Digital input DI1 (as indicated by 02.01 DI status , bit 0).	1073742337
	D12	Digital input DI2 (as indicated by 02.01 DI status , bit 1).	1073807873
	D13	Digital input DI3 (as indicated by 02.01 DI status , bit 2).	1073873409
	D14	Digital input DI4 (as indicated by 02.01 DI status , bit 3).	1073938945
	D15	Digital input DI5 (as indicated by 02.01 DI status , bit 4).	1074004481
	D16	Digital input DI6 (as indicated by 02.01 DI status , bit 5).	1074070017
	DIO4	Digital input/output DIO4 (as indicated by 02.03 DIO status , bit 3).	1073938947
	DIO5	Digital input/output DIO5 (as indicated by 02.03 DIO status , bit 4).	1074004483
	DIO6	Digital input/output DIO6 (as indicated by 02.03 DIO status , bit 5).	1074070019

No.	Name/Value	Description	FbEq
	Const	Bit pointer setting (see Terms and abbreviations on page 93).	-
	Pointer		
10.13	Em stop off3	<p>Selects the source of the emergency stop OFF3 signal. The drive is stopped along the emergency stop ramp time defined by parameter 22.12 Em stop time.</p> <p>0 = OFF3 active.</p> <p>Note: This parameter cannot be changed while the drive is running.</p>	
	DI1	Digital input DI1 (as indicated by 02.01 DI status , bit 0).	1073742337
	DI2	Digital input DI2 (as indicated by 02.01 DI status , bit 1).	1073807873
	DI3	Digital input DI3 (as indicated by 02.01 DI status , bit 2).	1073873409
	DI4	Digital input DI4 (as indicated by 02.01 DI status , bit 3).	1073938945
	DI5	Digital input DI5 (as indicated by 02.01 DI status , bit 4).	1074004481
	DI6	Digital input DI6 (as indicated by 02.01 DI status , bit 5).	1074070017
	DIO4	Digital input/output DIO4 (as indicated by 02.03 DIO status , bit 3).	1073938947
	DIO5	Digital input/output DIO5 (as indicated by 02.03 DIO status , bit 4).	1074004483
	DIO6	Digital input/output DIO6 (as indicated by 02.03 DIO status , bit 5).	1074070019
	Const	Bit pointer setting (see Terms and abbreviations on page 93).	-
	Pointer		
10.15	Em stop off1	<p>Selects the source of the emergency stop OFF1 signal. The drive is stopped using the active deceleration time.</p> <p>Emergency stop can also be activated through fieldbus (02.22 FBA main cw).</p> <p>0 = OFF1 active.</p> <p>Note: This parameter cannot be changed while the drive is running.</p>	
	DI1	Digital input DI1 (as indicated by 02.01 DI status , bit 0).	1073742337
	DI2	Digital input DI2 (as indicated by 02.01 DI status , bit 1).	1073807873
	DI3	Digital input DI3 (as indicated by 02.01 DI status , bit 2).	1073873409
	DI4	Digital input DI4 (as indicated by 02.01 DI status , bit 3).	1073938945
	DI5	Digital input DI5 (as indicated by 02.01 DI status , bit 4).	1074004481
	DI6	Digital input DI6 (as indicated by 02.01 DI status , bit 5).	1074070017
	DIO4	Digital input/output DIO4 (as indicated by 02.03 DIO status , bit 3).	1073938947
	DIO5	Digital input/output DIO5 (as indicated by 02.03 DIO status , bit 4).	1074004483
	DIO6	Digital input/output DIO6 (as indicated by 02.03 DIO status , bit 5).	1074070019
	Const	Bit pointer setting (see Terms and abbreviations on page 93).	-
	Pointer		

No.	Name/Value	Description	FbEq
10.17	Start enable	Selects the source for the start enable signal. 1 = Start enable. If the signal is switched off, the drive will not start or coasts to stop if running.	
	D11	Digital input DI1 (as indicated by 02.01 DI status , bit 0).	1073742337
	D12	Digital input DI2 (as indicated by 02.01 DI status , bit 1).	1073807873
	D13	Digital input DI3 (as indicated by 02.01 DI status , bit 2).	1073873409
	D14	Digital input DI4 (as indicated by 02.01 DI status , bit 3).	1073938945
	D15	Digital input DI5 (as indicated by 02.01 DI status , bit 4).	1074004481
	D16	Digital input DI6 (as indicated by 02.01 DI status , bit 5).	1074070017
	DIO4	Digital input/output DIO4 (as indicated by 02.03 DIO status , bit 3).	1073938947
	DIO5	Digital input/output DIO5 (as indicated by 02.03 DIO status , bit 4).	1074004483
	DIO6	Digital input/output DIO6 (as indicated by 02.03 DIO status , bit 5).	1074070019
	Const	Bit pointer setting (see Terms and abbreviations on page 93).	-
	Pointer		
10.19	Start inhibit	Enables the start inhibit function. The function prevents drive restart (i.e. protects against unexpected start) if <ul style="list-style-type: none"> the drive trips on a fault and the fault is reset, the run enable signal is activated while the start command is active (see parameter 10.11 Run enable), control changes from local to remote, or external control switches from EXT1 to EXT2 or vice versa. An active start inhibit can be reset with a stop command. Note that in certain applications it is necessary to allow the drive to restart.	
	Disabled	The start inhibit function is disabled.	0
	Enabled	The start inhibit function is enabled.	1
10.20	Start interl func	Defines how the start interlock input (DIIL) on the JCU control unit affects the drive operation.	
	Off2 stop	With the drive running: <ul style="list-style-type: none"> 1 = Normal operation. 0 = Stop by coasting. The drive can be restarted by restoring the start interlock signal and switching the start signal from 0 to 1. With the drive stopped: <ul style="list-style-type: none"> 1 = Starting allowed. 0 = Starting not allowed. 	0
	Off3 stop	With the drive running: <ul style="list-style-type: none"> 1 = Normal operation. 0 = Stop by ramping. The deceleration time is defined by parameter 22.12 Em stop time. The drive can be restarted by restoring the start interlock signal and switching the start signal from 0 to 1. With the drive stopped: <ul style="list-style-type: none"> 1 = Starting allowed. 0 = Starting not allowed. 	1

No.	Name/Value	Description	FbEq										
11 Start/stop mode		Start, stop, magnetization etc. settings.											
11.01	Start mode	<p>Selects the motor start function.</p> <p>Notes:</p> <ul style="list-style-type: none"> • Selections <i>Fast</i> and <i>Const time</i> are ignored if parameter 99.05 is set to <i>Scalar</i>. • Starting to a rotating machine is not possible when DC magnetizing is selected (<i>Fast</i> or <i>Const time</i>). • With permanent magnet motors, <i>Automatic</i> start must be used. 											
	Fast	<p>The drive pre-magnetizes the motor before start. The pre-magnetizing time is determined automatically, being typically 200 ms to 2 s depending on motor size. This mode should be selected if a high break-away torque is required.</p> <p>Note: This parameter cannot be changed while the drive is running.</p>	0										
	Const time	<p>The drive pre-magnetizes the motor before start. The pre-magnetizing time is defined by parameter <i>11.02 Dc-magn time</i>. This mode should be selected if constant pre-magnetizing time is required (e.g. if the motor start must be synchronized with the release of a mechanical brake). This setting also guarantees the highest possible break-away torque when the pre-magnetizing time is set long enough.</p> <p> WARNING! The drive will start after the set magnetizing time has passed even if motor magnetization is not completed. In applications where a full break-away torque is essential, ensure that the constant magnetizing time is long enough to allow generation of full magnetization and torque.</p>	1										
	Automatic	<p>Automatic start guarantees optimal motor start in most cases. It includes the flying start function (starting to a rotating machine) and the automatic restart function (a stopped motor can be restarted immediately without waiting the motor flux to die away). The drive motor control program identifies the flux as well as the mechanical state of the motor and starts the motor instantly under all conditions.</p> <p>Note: If parameter <i>99.05 Motor ctrl mode</i> is set to <i>Scalar</i>, no flying start or automatic restart is possible by default.</p>	2										
11.02	Dc-magn time	<p>Defines the constant DC magnetizing time. See parameter <i>11.01 Start mode</i>. After the start command, the drive automatically premagnetizes the motor the set time. To ensure full magnetizing, set this value to the same value as or higher than the rotor time constant. If not known, use the rule-of-thumb value given in the table below:</p> <table border="1" data-bbox="475 1697 1185 1944"> <thead> <tr> <th>Motor rated power</th> <th>Constant magnetizing time</th> </tr> </thead> <tbody> <tr> <td>< 1 kW</td> <td>≥ 50 to 100 ms</td> </tr> <tr> <td>1 to 10 kW</td> <td>≥ 100 to 200 ms</td> </tr> <tr> <td>10 to 200 kW</td> <td>≥ 200 to 1000 ms</td> </tr> <tr> <td>200 to 1000 kW</td> <td>≥ 1000 to 2000 ms</td> </tr> </tbody> </table> <p>Note: This parameter cannot be changed while the drive is running.</p>	Motor rated power	Constant magnetizing time	< 1 kW	≥ 50 to 100 ms	1 to 10 kW	≥ 100 to 200 ms	10 to 200 kW	≥ 200 to 1000 ms	200 to 1000 kW	≥ 1000 to 2000 ms	
Motor rated power	Constant magnetizing time												
< 1 kW	≥ 50 to 100 ms												
1 to 10 kW	≥ 100 to 200 ms												
10 to 200 kW	≥ 200 to 1000 ms												
200 to 1000 kW	≥ 1000 to 2000 ms												
	0 ... 10000 ms	Constant DC magnetizing time.	1 = 1 ms										

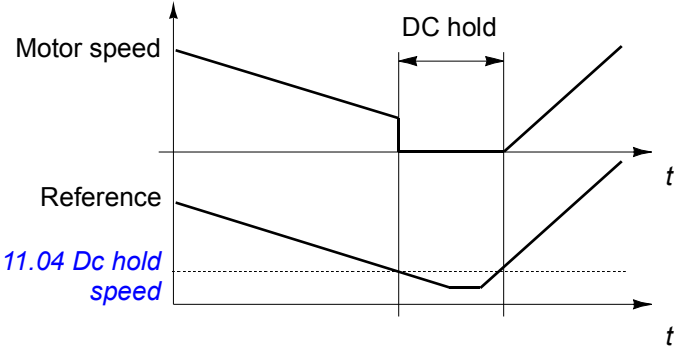
No.	Name/Value	Description	FbEq
11.03	Stop mode	Selects the motor stop function.	
	Coast	Stop by cutting of the motor power supply. The motor coasts to a stop.  WARNING! If the mechanical brake is used, ensure it is safe to stop the drive by coasting.	1
	Ramp	Stop along ramp. See parameter group 22 Speed ref ramp on page 155 .	2
11.04	Dc hold speed	Defines the DC hold speed. See parameter 11.06 Dc hold .	
	0.0 ... 1000.0 rpm	DC hold speed.	10 = 1 rpm
11.05	Dc hold curr ref	Defines the DC hold current in percent of the motor nominal current. See parameter 11.06 Dc hold .	
	0 ... 100%	DC hold current.	1 = 1%
11.06	Dc hold	<p>Enables the DC hold function. The function makes it possible to lock the rotor at zero speed.</p> <p>When both the reference and the speed drop below the value of parameter 11.04 Dc hold speed, the drive will stop generating sinusoidal current and start to inject DC into the motor. The current is set by parameter 11.05 Dc hold curr ref. When the reference speed exceeds parameter 11.04 Dc hold speed, normal drive operation continues.</p>  <p>Notes:</p> <ul style="list-style-type: none"> • The DC hold function has no effect if the start signal is switched off. • The DC hold function can only be activated in speed control mode. • The DC hold function cannot be activated if parameter 99.05 Motor ctrl mode is set to <i>Scalar</i>. • Injecting DC current into the motor causes the motor to heat up. In applications where long DC hold times are required, externally ventilated motors should be used. If the DC hold period is long, the DC hold cannot prevent the motor shaft from rotating if a constant load is applied to the motor. 	
	Disabled	The DC hold function is disabled.	0
	Enabled	The DC hold function is enabled.	1
11.07	Autophasing mode	Selects the way autophasing is performed during the ID run. See section Autophasing on page 58 .	

No.	Name/Value	Description	FbEq
	Turning	This mode gives the most accurate autophasing result. This mode can be used, and is recommended, if it is allowed for the motor to rotate during the ID run and the start-up is not time-critical. Note: This mode will cause the motor to rotate during the ID run.	0
	Standstill 1	Faster than the <i>Turning</i> mode, but not as accurate. The motor will not rotate.	1
	Standstill 2	An alternative standstill autophasing mode that can be used if the <i>Turning</i> mode cannot be used, and the <i>Standstill 1</i> mode gives erratic results. However, this mode is considerably slower than <i>Standstill 1</i> .	2

12 Operating mode		Operating mode and external reference source selection.	
12.01	Ext1/Ext2 sel	Selects the source for external control location EXT1/EXT2 selection. 0 = EXT1 1 = EXT2	
	DI1	Digital input DI1 (as indicated by <i>02.01 DI status</i> , bit 0).	1073742337
	DI2	Digital input DI2 (as indicated by <i>02.01 DI status</i> , bit 1).	1073807873
	DI3	Digital input DI3 (as indicated by <i>02.01 DI status</i> , bit 2).	1073873409
	DI4	Digital input DI4 (as indicated by <i>02.01 DI status</i> , bit 3).	1073938945
	DI5	Digital input DI5 (as indicated by <i>02.01 DI status</i> , bit 4).	1074004481
	DI6	Digital input DI6 (as indicated by <i>02.01 DI status</i> , bit 5).	1074070017
	DIO4	Digital input/output DIO4 (as indicated by <i>02.03 DIO status</i> , bit 3).	1073938947
	DIO5	Digital input/output DIO5 (as indicated by <i>02.03 DIO status</i> , bit 4).	1074004483
	DIO6	Digital input/output DIO6 (as indicated by <i>02.03 DIO status</i> , bit 5).	1074070019
	Const	Bit pointer setting (see <i>Terms and abbreviations</i> on page 93).	-
	Pointer		
12.03	Ext1 ctrl mode	Selects the operating mode for external control location EXT1.	
	Speed	Speed control. Torque reference is <i>03.09 Torq ref sp ctrl</i> .	1
	Torque	Torque control. Torque reference is <i>03.12 Torq ref sp lim</i> .	2
	Min	Combination of selections <i>Speed</i> and <i>Torque</i> : Torque selector compares the torque reference and the speed controller output and the smaller of the two is used.	3
	Max	Combination of selections <i>Speed</i> and <i>Torque</i> : Torque selector compares the torque reference and the speed controller output and the greater of the two is used.	4
	Add	Combination of selections <i>Speed</i> and <i>Torque</i> : Torque selector adds the speed controller output to the torque reference.	5
12.05	Ext2 ctrl mode	Selects the operating mode for external control location EXT2.	
	Speed	Speed control. Torque reference is <i>03.09 Torq ref sp ctrl</i> .	1
	Torque	Torque control. Torque reference is <i>03.12 Torq ref sp lim</i> .	2

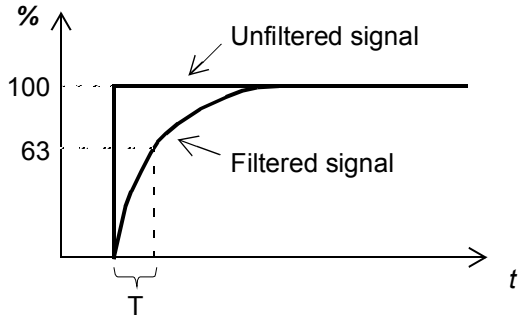
No.	Name/Value	Description	FbEq
	Min	Combination of selections <i>Speed</i> and <i>Torque</i> : Torque selector compares the torque reference and the speed controller output and the smaller of the two is used.	3
	Max	Combination of selections <i>Speed</i> and <i>Torque</i> : Torque selector compares the torque reference and the speed controller output and the greater of the two is used.	4
	Add	Combination of selections <i>Speed</i> and <i>Torque</i> : Torque selector adds the speed controller output to the torque reference.	5
13 Analogue inputs		Analog input signal processing.	
13.01	AI1 filt time	<p>Defines the filter time constant for analogue input AI1.</p>  <p style="text-align: center;">$O = I \times (1 - e^{-t/T})$</p> <p>I = filter input (step) O = filter output t = time T = filter time constant</p> <p>Note: The signal is also filtered due to the signal interface hardware (approximately 0.25 ms time constant). This cannot be changed by any parameter.</p>	
	0.000 ... 30.000 s	Filter time constant.	1000 = 1 s
13.02	AI1 max	Defines the maximum value for analogue input AI1. The input type is selected with jumper J1 on the JCU Control Unit.	
	-22.000 ... 22.000 mA or -11.000 ... 11.000 V	Maximum AI1 value.	1000 = 1 unit
13.03	AI1 min	Defines the minimum value for analogue input AI1. The input type is selected with jumper J1 on the JCU Control Unit.	
	-22.000 ... 22.000 mA or -11.000 ... 11.000 V	Minimum AI1 value.	1000 = 1 unit

120 Parameters

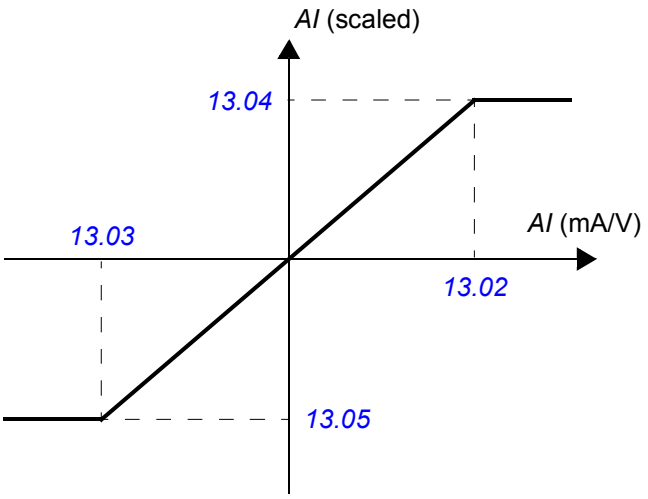
No.	Name/Value	Description	FbEq
13.04	AI1 max scale	<p>Defines the real value that corresponds to the maximum analogue input AI1 value defined by parameter 13.02 AI1 max.</p> 	
	-32768.000 ... 32768.000	Real value corresponding to maximum AI1 value.	1000 = 1
13.05	AI1 min scale	<p>Defines the real value that corresponds to the minimum analogue input AI1 value defined by parameter 13.03 AI1 min. See the drawing at parameter 13.04 AI1 max scale.</p>	
	-32768.000 ...32768.000	Real value corresponding to minimum AI1 value.	1000 = 1
13.06	AI2 filt time	<p>Defines the filter time constant for analogue input AI2. See parameter 13.01 AI1 filt time.</p>	
	0.000 ... 30.000 s	Filter time constant.	1000 = 1 s
13.07	AI2 max	<p>Defines the maximum value for analogue input AI2. The input type is selected with jumper J2 on the JCU Control Unit.</p>	
	-22.000 ... 22.000 mA or -11.000 ... 11.000 V	AI2 maximum value.	1000 = 1 unit
13.08	AI2 min	<p>Defines the minimum value for analogue input AI2. The input type is selected with jumper J2 on the JCU Control Unit.</p>	
	-22.000 ... 22.000 mA or -11.000 ... 11.000 V	AI2 minimum value.	1000 = 1 unit

No.	Name/Value	Description	FbEq
13.09	AI2 max scale	Defines the real value that corresponds to the maximum analogue input AI2 value defined by parameter 13.07 AI2 max .	
	-32768.000 ... 32768.000	Real value corresponding to maximum AI2 value.	1000 = 1
13.10	AI2 min scale	Defines the real value that corresponds to the minimum analogue input AI2 value defined by parameter 13.08 AI2 min . See the drawing at parameter 13.09 AI2 max scale .	
	-32768.000 ... 32768.000	Real value corresponding to minimum AI2 value.	1000 = 1
13.11	AI3 filt time	Defines the filter time constant for analogue input AI3. See parameter 13.01 AI1 filt time .	
	0.000 ... 30.000 s	Filter time constant.	1000 = 1 s
13.12	AI3 max	Defines the maximum value for analogue input AI3. The input type depends on the type and/or settings of the I/O extension module installed. See the user documentation of the extension module.	
	-22.000 ... 22.000 mA or -11.000 ... 11.000 V	AI3 maximum value.	1000 = 1 unit
13.13	AI3 min	Defines the minimum value for analogue input AI3. The input type depends on the type and/or settings of the I/O extension module installed. See the user documentation of the extension module.	
	-22.000 ... 22.000 mA or -11.000 ... 11.000 V	AI3 minimum value.	1000 = 1 unit

122 Parameters

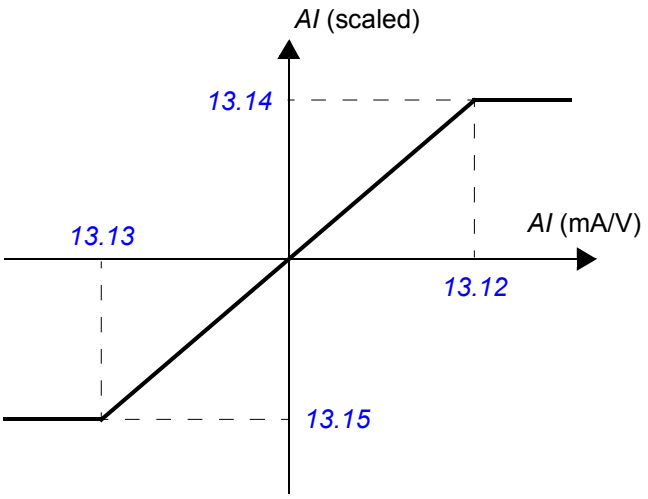

No.	Name/Value	Description	FbEq
13.14	AI3 max scale	<p>Defines the real value that corresponds to the maximum analogue input AI3 value defined by parameter 13.12 AI3 max.</p> 	
	-32768.000 ... 32768.000	Real value corresponding to maximum AI3 value.	1000 = 1
13.15	AI3 min scale	<p>Defines the real value that corresponds to the minimum analogue input AI3 value defined by parameter 13.13 AI3 min. See the drawing at parameter 13.14 AI3 max scale.</p>	
	-32768.000 ... 32768.000	Real value corresponding to minimum AI3 value.	1000 = 1
13.16	AI4 filt time	<p>Defines the filter time constant for analogue input AI4. See parameter 13.01 AI1 filt time.</p>	
	0.000 ... 30.000 s	Filter time constant.	1000 = 1 s
13.17	AI4 max	<p>Defines the maximum value for analogue input AI4. The input type depends on the type and/or settings of the I/O extension module installed. See the user documentation of the extension module.</p>	
	-22.000 ... 22.000 mA or -11.000 ... 11.000 V	AI4 maximum value.	1000 = 1 unit
13.18	AI4 min	<p>Defines the minimum value for analogue input AI4. The input type depends on the type and/or settings of the I/O extension module installed. See the user documentation of the extension module.</p>	
	-22.000 ... 22.000 mA or -11.000 ... 11.000 V	AI4 minimum value.	1000 = 1 unit

No.	Name/Value	Description	FbEq
13.19	AI4 max scale	Defines the real value that corresponds to the maximum analogue input AI4 value defined by parameter 13.17 AI4 max .	
	-32768.000 ... 32768.000	Real value corresponding to maximum AI4 value.	1000 = 1
13.20	AI4 min scale	Defines the real value that corresponds to the minimum analogue input AI4 value defined by parameter 13.18 AI4 min . See the drawing at parameter 13.19 AI4 max scale .	
	-32768.000 ... 32768.000	Real value corresponding to minimum AI4 value.	1000 = 1
13.21	AI5 filt time	Defines the filter time constant for analogue input AI5. See parameter 13.01 AI1 filt time .	
	0.000 ... 30.000 s	Filter time constant.	1000 = 1 s
13.22	AI5 max	Defines the maximum value for analogue input AI5. The input type depends on the type and/or settings of the I/O extension module installed. See the user documentation of the extension module.	
	-22.000 ... 22.000 mA or -11.000 ... 11.000 V	AI5 maximum value.	1000 = 1 unit
13.23	AI5 min	Defines the minimum value for analogue input AI5. The input type depends on the type and/or settings of the I/O extension module installed. See the user documentation of the extension module.	
	-22.000 ... 22.000 mA or -11.000 ... 11.000 V	AI5 minimum value.	1000 = 1 unit

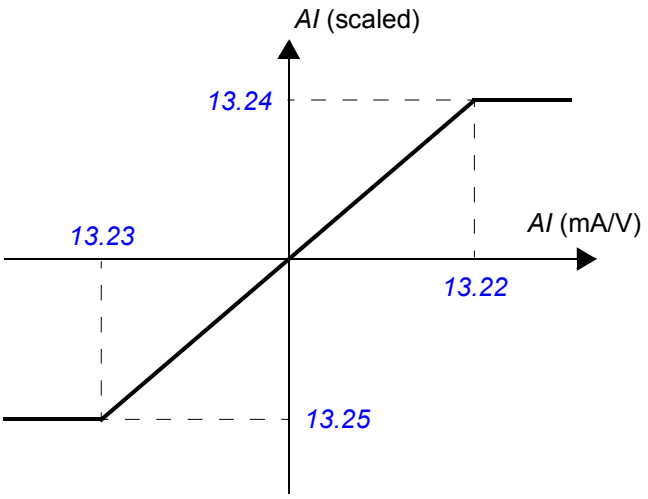
124 Parameters

No.	Name/Value	Description	FbEq
13.24	AI5 max scale	<p>Defines the real value that corresponds to the maximum analogue input AI5 value defined by parameter 13.22 AI5 max.</p> 	
	-32768.000 ... 32768.000	Real value corresponding to maximum AI5 value.	1000 = 1
13.25	AI5 min scale	<p>Defines the real value that corresponds to the minimum analogue input AI5 value defined by parameter 13.23 AI5 min. See the drawing at parameter 13.24 AI5 max scale.</p>	
	-32768.000 ... 32768.000	Real value corresponding to minimum AI5 value.	1000 = 1
13.26	AI6 filt time	<p>Defines the filter time constant for analogue input AI6. See parameter 13.01 AI1 filt time.</p>	
	0.000 ... 30.000 s	Filter time constant.	1000 = 1 s
13.27	AI6 max	<p>Defines the maximum value for analogue input AI6. The input type depends on the type and/or settings of the I/O extension module installed. See the user documentation of the extension module.</p>	
	-22.000 ... 22.000 mA or -11.000 ... 11.000 V	AI6 maximum value.	1000 = 1 unit
13.28	AI6 min	<p>Defines the minimum value for analogue input AI6. The input type depends on the type and/or settings of the I/O extension module installed. See the user documentation of the extension module.</p>	
	-22.000 ... 22.000 mA or -11.000 ... 11.000 V	AI6 minimum value.	1000 = 1 unit

No.	Name/Value	Description	FbEq
13.29	AI6 max scale	Defines the real value that corresponds to the maximum analogue input AI6 value defined by parameter 13.27 AI6 max .	
	-32768.000 ... 32768.000	Real value corresponding to maximum AI6 value.	1000 = 1
13.30	AI6 min scale	Defines the real value that corresponds to the minimum analogue input AI6 value defined by parameter 13.28 AI6 min . See the drawing at parameter 13.29 AI6 max scale .	
	-32768.000 ... 32768.000	Real value corresponding to minimum AI6 value.	1000 = 1
13.31	AI tune	Triggers the AI tuning function. Connect the signal to the input and select the appropriate tuning function.	
	No action	AI tune is not activated.	0
	AI1 min tune	Current analogue input AI1 signal value is set as minimum value of AI1 into parameter 13.03 AI1 min . The value reverts back to <i>No action</i> automatically.	1
	AI1 max tune	Current analogue input AI1 signal value is set as maximum value of AI1 into parameter 13.02 AI1 max . The value reverts back to <i>No action</i> automatically.	2
	AI2 min tune	Current analogue input AI2 signal value is set as minimum value of AI2 into parameter 13.08 AI2 min . The value reverts back to <i>No action</i> automatically.	3
	AI2 max tune	Current analogue input AI2 signal value is set as maximum value of AI2 into parameter 13.07 AI2 max . The value reverts back to <i>No action</i> automatically.	4
13.32	AI superv func	Selects how the drive reacts when analogue input signal limit is reached. The limit is selected by parameter 13.33 AI superv cw .	
	No	No action taken.	0
	Fault	The drive trips on an AI SUPERVISION fault.	1

No.	Name/Value	Description	FbEq															
	Spd ref Safe	The drive generates an AI SUPERVISION alarm and sets the speed to the speed defined by parameter 30.02 Speed ref safe .  WARNING! Make sure that it is safe to continue operation in case of a communication break.	2															
	Last speed	The drive generates an AI SUPERVISION alarm and freezes the speed to the level the drive was operating at. The speed is determined by the average speed over the previous 10 seconds.  WARNING! Make sure that it is safe to continue operation in case of a communication break.	3															
13.33	AI superv cw	Selects the analogue input signal supervision limit.																
<table border="1"> <thead> <tr> <th>Bit</th> <th>Supervision</th> <th>Action selected by parameter 13.32 AI superv func is taken if</th> </tr> </thead> <tbody> <tr> <td>0</td> <td>AI1<min</td> <td>AI1 signal value falls below the value defined by equation: par. 13.03 AI1 min - 0.5 mA or V</td> </tr> <tr> <td>1</td> <td>AI1>max</td> <td>AI1 signal value exceeds the value defined by equation: par. 13.02 AI1 max + 0.5 mA or V</td> </tr> <tr> <td>2</td> <td>AI2<min</td> <td>AI2 signal value falls below the value defined by equation: par. 13.08 AI2 min - 0.5 mA or V</td> </tr> <tr> <td>3</td> <td>AI2>max</td> <td>AI2 signal value exceeds the value defined by equation: par. 13.07 AI2 max + 0.5 mA or V</td> </tr> </tbody> </table>				Bit	Supervision	Action selected by parameter 13.32 AI superv func is taken if	0	AI1<min	AI1 signal value falls below the value defined by equation: par. 13.03 AI1 min - 0.5 mA or V	1	AI1>max	AI1 signal value exceeds the value defined by equation: par. 13.02 AI1 max + 0.5 mA or V	2	AI2<min	AI2 signal value falls below the value defined by equation: par. 13.08 AI2 min - 0.5 mA or V	3	AI2>max	AI2 signal value exceeds the value defined by equation: par. 13.07 AI2 max + 0.5 mA or V
Bit	Supervision	Action selected by parameter 13.32 AI superv func is taken if																
0	AI1<min	AI1 signal value falls below the value defined by equation: par. 13.03 AI1 min - 0.5 mA or V																
1	AI1>max	AI1 signal value exceeds the value defined by equation: par. 13.02 AI1 max + 0.5 mA or V																
2	AI2<min	AI2 signal value falls below the value defined by equation: par. 13.08 AI2 min - 0.5 mA or V																
3	AI2>max	AI2 signal value exceeds the value defined by equation: par. 13.07 AI2 max + 0.5 mA or V																
		Example: If parameter value is set to 0b0010, bit 1 AI1>max is selected.																

14 Digital I/O		Configuration of digital input/outputs and relay outputs.																			
14.01	DI invert mask	Inverts status of digital inputs as reported by 02.01 DI status .																			
<table border="1"> <thead> <tr> <th>Bit</th> <th>Name</th> </tr> </thead> <tbody> <tr> <td>0</td> <td>1 = Invert DI1</td> </tr> <tr> <td>1</td> <td>1 = Invert DI2</td> </tr> <tr> <td>2</td> <td>1 = Invert DI3</td> </tr> <tr> <td>3</td> <td>1 = Invert DI4</td> </tr> <tr> <td>4</td> <td>1 = Invert DI5</td> </tr> <tr> <td>5</td> <td>1 = Invert DI6</td> </tr> <tr> <td>6</td> <td>Reserved</td> </tr> <tr> <td>7</td> <td>1 = Invert DI8 (on optional FIO-21 I/O Extension)</td> </tr> </tbody> </table>				Bit	Name	0	1 = Invert DI1	1	1 = Invert DI2	2	1 = Invert DI3	3	1 = Invert DI4	4	1 = Invert DI5	5	1 = Invert DI6	6	Reserved	7	1 = Invert DI8 (on optional FIO-21 I/O Extension)
Bit	Name																				
0	1 = Invert DI1																				
1	1 = Invert DI2																				
2	1 = Invert DI3																				
3	1 = Invert DI4																				
4	1 = Invert DI5																				
5	1 = Invert DI6																				
6	Reserved																				
7	1 = Invert DI8 (on optional FIO-21 I/O Extension)																				
14.02	DIO1 conf	Selects whether DIO1 is used as a digital output or input.																			
	Output	DIO1 is used as a digital output.	0																		
	Input	DIO1 is used as a digital input.	1																		
14.03	DIO1 out src	Selects a drive signal to be connected to digital output DIO1 (when 14.02 DIO1 conf is set to <i>Output</i>).																			
	Brake cmd	03.16 Brake command (see page 101).	1073742608																		
	Ready	Bit 0 of 06.01 Status word1 (see page 103).	1073743361																		
	Enabled	Bit 1 of 06.01 Status word1 (see page 103).	1073808897																		
	Started	Bit 2 of 06.01 Status word1 (see page 103).	1073874433																		

No.	Name/Value	Description	FbEq
	Running	Bit 3 of 06.01 Status word1 (see page 103).	1073939969
	Alarm	Bit 7 of 06.01 Status word1 (see page 103).	1074202113
	Ext2 active	Bit 8 of 06.01 Status word1 (see page 103).	1074267649
	Fault	Bit 10 of 06.01 Status word1 (see page 103).	1074398721
	Fault(-1)	Bit 12 of 06.01 Status word1 (see page 103).	1074529793
	Ready relay	Bit 2 of 06.02 Status word2 (see page 104).	1073874434
	RunningRelay	Bit 3 of 06.02 Status word2 (see page 104).	1073939970
	Ref running	Bit 4 of 06.02 Status word2 (see page 104).	1074005506
	Charge ready	Bit 9 of 06.02 Status word2 (see page 104).	1074333186
	Neg speed	Bit 0 of 06.03 Speed ctrl stat (see page 105).	1073743363
	Zero speed	Bit 1 of 06.03 Speed ctrl stat (see page 105).	1073808899
	Above limit	Bit 2 of 06.03 Speed ctrl stat (see page 105).	1073874435
	At setpoint	Bit 3 of 06.03 Speed ctrl stat (see page 105).	1073939971
	Supervision1	Bit 0 of 06.13 Superv status (see page 106).	1073743373
	Supervision2	Bit 1 of 06.13 Superv status (see page 106).	1073808909
	Supervision3	Bit 2 of 06.13 Superv status (see page 106).	1073874445
	Const	Bit pointer setting (see Terms and abbreviations on page 93).	-
	Pointer		
14.04	DIO1 Ton	Defines the on (activation) delay for digital input/output DIO1 when 14.02 DIO1 conf is set to Output .	
<p>The diagram shows two waveforms: 'Drive status' and 'DIO1 status' plotted against 'Time'. The 'Drive status' signal has several pulses. The 'DIO1 status' signal shows a delay between the start of a pulse in 'Drive status' and the start of a pulse in 'DIO1 status'. This delay is labeled as t_{On}. Similarly, when 'Drive status' returns to 0, 'DIO1 status' remains at 1 for a short duration before returning to 0, labeled as t_{Off}.</p> <p style="text-align: center;"> t_{On} 14.04 DIO1 Ton t_{Off} 14.05 DIO1 Toff </p>			
	0.0 ... 3000.0 s	On (activation) delay for DIO1 when set as an output.	10 = 1 s
14.05	DIO1 Toff	Defines the off (deactivation) delay for digital input/output DIO1 when 14.02 DIO1 conf is set to Output . See parameter 14.04 DIO1 Ton .	
	0.0 ... 3000.0 s	Off (deactivation) delay for DIO1 when set as an output.	10 = 1 s
14.06	DIO2 conf	Selects whether DIO2 is used as a digital output, digital input or frequency input.	
	Output	DIO2 is used as a digital output.	0
	Input	DIO2 is used as a digital input.	1
	Freq input	DIO2 is used as a frequency input.	2

No.	Name/Value	Description	FbEq
14.07	DIO2 out src	Selects a drive signal to be connected to digital output DIO2 (when 14.06 DIO2 conf is set to <i>Output</i>).	
	Brake cmd	03.16 Brake command (see page 101).	1073742608
	Ready	Bit 0 of 06.01 Status word1 (see page 103).	1073743361
	Enabled	Bit 1 of 06.01 Status word1 (see page 103).	1073808897
	Started	Bit 2 of 06.01 Status word1 (see page 103).	1073874433
	Running	Bit 3 of 06.01 Status word1 (see page 103).	1073939969
	Alarm	Bit 7 of 06.01 Status word1 (see page 103).	1074202113
	Ext2 active	Bit 8 of 06.01 Status word1 (see page 103).	1074267649
	Fault	Bit 10 of 06.01 Status word1 (see page 103).	1074398721
	Fault(-1)	Bit 12 of 06.01 Status word1 (see page 103).	1074529793
	Ready relay	Bit 2 of 06.02 Status word2 (see page 104).	1073874434
	RunningRelay	Bit 3 of 06.02 Status word2 (see page 104).	1073939970
	Ref running	Bit 4 of 06.02 Status word2 (see page 104).	1074005506
	Charge ready	Bit 9 of 06.02 Status word2 (see page 104).	1074333186
	Neg speed	Bit 0 of 06.03 Speed ctrl stat (see page 105).	1073743363
	Zero speed	Bit 1 of 06.03 Speed ctrl stat (see page 105).	1073808899
	Above limit	Bit 2 of 06.03 Speed ctrl stat (see page 105).	1073874435
	At setpoint	Bit 3 of 06.03 Speed ctrl stat (see page 105).	1073939971
	Supervision1	Bit 0 of 06.13 Superv status (see page 106).	1073743373
	Supervision2	Bit 1 of 06.13 Superv status (see page 106).	1073808909
	Supervision3	Bit 2 of 06.13 Superv status (see page 106).	1073874445
	Const	Bit pointer setting (see Terms and abbreviations on page 93).	-
	Pointer		
14.08	DIO2 Ton	Defines the on (activation) delay for digital input/output DIO2 when 14.06 DIO2 conf is set to <i>Output</i> .	
<p style="text-align: center;"> t_{On} t_{Off} t_{On} t_{Off} </p> <p style="text-align: center;"> t_{On} 14.08 DIO2 Ton t_{Off} 14.09 DIO2 Toff </p>			
	0.0 ... 3000.0 s	On (activation) delay for DIO2 when set as an output.	10 = 1 s

No.	Name/Value	Description	FbEq
14.09	DIO2 Toff	Defines the off (deactivation) delay for digital input/output DIO2 when 14.06 DIO2 conf is set to <i>Output</i> . See parameter 14.08 DIO2 Ton .	
	0.0 ... 3000.0 s	Off (deactivation) delay for DIO2 when set as an output.	10 = 1 s
14.10	DIO3 conf	Selects whether DIO3 is used as a digital output, digital input or frequency output.	
	Output	DIO3 is used as a digital output.	0
	Input	DIO3 is used as a digital input.	1
	Freq output	DIO3 is used as a frequency output.	3
14.11	DIO3 out src	Selects a drive signal to be connected to digital output DIO3 (when 14.10 DIO3 conf is set to <i>Output</i>).	
	Brake cmd	03.16 Brake command (see page 101).	1073742608
	Ready	Bit 0 of 06.01 Status word1 (see page 103).	1073743361
	Enabled	Bit 1 of 06.01 Status word1 (see page 103).	1073808897
	Started	Bit 2 of 06.01 Status word1 (see page 103).	1073874433
	Running	Bit 3 of 06.01 Status word1 (see page 103).	1073939969
	Alarm	Bit 7 of 06.01 Status word1 (see page 103).	1074202113
	Ext2 active	Bit 8 of 06.01 Status word1 (see page 103).	1074267649
	Fault	Bit 10 of 06.01 Status word1 (see page 103).	1074398721
	Fault(-1)	Bit 12 of 06.01 Status word1 (see page 103).	1074529793
	Ready relay	Bit 2 of 06.02 Status word2 (see page 104).	1073874434
	RunningRelay	Bit 3 of 06.02 Status word2 (see page 104).	1073939970
	Ref running	Bit 4 of 06.02 Status word2 (see page 104).	1074005506
	Charge ready	Bit 9 of 06.02 Status word2 (see page 104).	1074333186
	Neg speed	Bit 0 of 06.03 Speed ctrl stat (see page 105).	1073743363
	Zero speed	Bit 1 of 06.03 Speed ctrl stat (see page 105).	1073808899
	Above limit	Bit 2 of 06.03 Speed ctrl stat (see page 105).	1073874435
	At setpoint	Bit 3 of 06.03 Speed ctrl stat (see page 105).	1073939971
	Supervision1	Bit 0 of 06.13 Superv status (see page 106).	1073743373
	Supervision2	Bit 1 of 06.13 Superv status (see page 106).	1073808909
	Supervision3	Bit 2 of 06.13 Superv status (see page 106).	1073874445
	Const	Bit pointer setting (see Terms and abbreviations on page 93).	-
	Pointer		
14.14	DIO4 conf	Selects whether DIO4 is used as a digital output or input.	
	Output	DIO4 is used as a digital output.	0
	Input	DIO4 is used as a digital input.	1
14.15	DIO4 out src	Selects a drive signal to be connected to digital output DIO4 (when 14.14 DIO4 conf is set to <i>Output</i>).	
	Brake cmd	03.16 Brake command (see page 101).	1073742608
	Ready	Bit 0 of 06.01 Status word1 (see page 103).	1073743361
	Enabled	Bit 1 of 06.01 Status word1 (see page 103).	1073808897
	Started	Bit 2 of 06.01 Status word1 (see page 103).	1073874433
	Running	Bit 3 of 06.01 Status word1 (see page 103).	1073939969

130 Parameters

No.	Name/Value	Description	FbEq
	Alarm	Bit 7 of 06.01 Status word1 (see page 103).	1074202113
	Ext2 active	Bit 8 of 06.01 Status word1 (see page 103).	1074267649
	Fault	Bit 10 of 06.01 Status word1 (see page 103).	1074398721
	Fault(-1)	Bit 12 of 06.01 Status word1 (see page 103).	1074529793
	Ready relay	Bit 2 of 06.02 Status word2 (see page 104).	1073874434
	RunningRelay	Bit 3 of 06.02 Status word2 (see page 104).	1073939970
	Ref running	Bit 4 of 06.02 Status word2 (see page 104).	1074005506
	Charge ready	Bit 9 of 06.02 Status word2 (see page 104).	1074333186
	Neg speed	Bit 0 of 06.03 Speed ctrl stat (see page 105).	1073743363
	Zero speed	Bit 1 of 06.03 Speed ctrl stat (see page 105).	1073808899
	Above limit	Bit 2 of 06.03 Speed ctrl stat (see page 105).	1073874435
	At setpoint	Bit 3 of 06.03 Speed ctrl stat (see page 105).	1073939971
	Supervision1	Bit 0 of 06.13 Superv status (see page 106).	1073743373
	Supervision2	Bit 1 of 06.13 Superv status (see page 106).	1073808909
	Supervision3	Bit 2 of 06.13 Superv status (see page 106).	1073874445
	Const	Bit pointer setting (see Terms and abbreviations on page 93).	-
	Pointer		
14.18	DIO5 conf	Selects whether DIO5 is used as a digital output or input.	
	Output	DIO5 is used as a digital output.	0
	Input	DIO5 is used as a digital input.	1
14.19	DIO5 out src	Selects a drive signal to be connected to digital output DIO5 (when 14.18 DIO5 conf is set to Output).	
	Brake cmd	03.16 Brake command (see page 101).	1073742608
	Ready	Bit 0 of 06.01 Status word1 (see page 103).	1073743361
	Enabled	Bit 1 of 06.01 Status word1 (see page 103).	1073808897
	Started	Bit 2 of 06.01 Status word1 (see page 103).	1073874433
	Running	Bit 3 of 06.01 Status word1 (see page 103).	1073939969
	Alarm	Bit 7 of 06.01 Status word1 (see page 103).	1074202113
	Ext2 active	Bit 8 of 06.01 Status word1 (see page 103).	1074267649
	Fault	Bit 10 of 06.01 Status word1 (see page 103).	1074398721
	Fault(-1)	Bit 12 of 06.01 Status word1 (see page 103).	1074529793
	Ready relay	Bit 2 of 06.02 Status word2 (see page 104).	1073874434
	RunningRelay	Bit 3 of 06.02 Status word2 (see page 104).	1073939970
	Ref running	Bit 4 of 06.02 Status word2 (see page 104).	1074005506
	Charge ready	Bit 9 of 06.02 Status word2 (see page 104).	1074333186
	Neg speed	Bit 0 of 06.03 Speed ctrl stat (see page 105).	1073743363
	Zero speed	Bit 1 of 06.03 Speed ctrl stat (see page 105).	1073808899
	Above limit	Bit 2 of 06.03 Speed ctrl stat (see page 105).	1073874435
	At setpoint	Bit 3 of 06.03 Speed ctrl stat (see page 105).	1073939971
	Supervision1	Bit 0 of 06.13 Superv status (see page 106).	1073743373
	Supervision2	Bit 1 of 06.13 Superv status (see page 106).	1073808909

No.	Name/Value	Description	FbEq
	Supervision3	Bit 2 of 06.13 Superv status (see page 106).	1073874445
	Const	Bit pointer setting (see Terms and abbreviations on page 93).	-
	Pointer		
14.22	DIO6 conf	Selects whether DIO6 is used as a digital output or input.	
	Output	DIO6 is used as a digital output.	0
	Input	DIO6 is used as a digital input.	1
14.23	DIO6 out src	Selects a drive signal to be connected to digital output DIO6 (when 14.22 DIO6 conf is set to <i>Output</i>).	
	Brake cmd	03.16 Brake command (see page 101).	1073742608
	Ready	Bit 0 of 06.01 Status word1 (see page 103).	1073743361
	Enabled	Bit 1 of 06.01 Status word1 (see page 103).	1073808897
	Started	Bit 2 of 06.01 Status word1 (see page 103).	1073874433
	Running	Bit 3 of 06.01 Status word1 (see page 103).	1073939969
	Alarm	Bit 7 of 06.01 Status word1 (see page 103).	1074202113
	Ext2 active	Bit 8 of 06.01 Status word1 (see page 103).	1074267649
	Fault	Bit 10 of 06.01 Status word1 (see page 103).	1074398721
	Fault(-1)	Bit 12 of 06.01 Status word1 (see page 103).	1074529793
	Ready relay	Bit 2 of 06.02 Status word2 (see page 104).	1073874434
	RunningRelay	Bit 3 of 06.02 Status word2 (see page 104).	1073939970
	Ref running	Bit 4 of 06.02 Status word2 (see page 104).	1074005506
	Charge ready	Bit 9 of 06.02 Status word2 (see page 104).	1074333186
	Neg speed	Bit 0 of 06.03 Speed ctrl stat (see page 105).	1073743363
	Zero speed	Bit 1 of 06.03 Speed ctrl stat (see page 105).	1073808899
	Above limit	Bit 2 of 06.03 Speed ctrl stat (see page 105).	1073874435
	At setpoint	Bit 3 of 06.03 Speed ctrl stat (see page 105).	1073939971
	Supervision1	Bit 0 of 06.13 Superv status (see page 106).	1073743373
	Supervision2	Bit 1 of 06.13 Superv status (see page 106).	1073808909
	Supervision3	Bit 2 of 06.13 Superv status (see page 106).	1073874445
	Const	Bit pointer setting (see Terms and abbreviations on page 93).	-
	Pointer		
14.26	DIO7 conf	Selects whether DIO7 is used as a digital output or input.	
	Output	DIO7 is used as a digital output.	0
	Input	DIO7 is used as a digital input.	1
14.27	DIO7 out src	Selects a drive signal to be connected to digital output DIO7 (when 14.26 DIO7 conf is set to <i>Output</i>).	
	Brake cmd	03.16 Brake command (see page 101).	1073742608
	Ready	Bit 0 of 06.01 Status word1 (see page 103).	1073743361
	Enabled	Bit 1 of 06.01 Status word1 (see page 103).	1073808897
	Started	Bit 2 of 06.01 Status word1 (see page 103).	1073874433
	Running	Bit 3 of 06.01 Status word1 (see page 103).	1073939969
	Alarm	Bit 7 of 06.01 Status word1 (see page 103).	1074202113
	Ext2 active	Bit 8 of 06.01 Status word1 (see page 103).	1074267649

132 Parameters

No.	Name/Value	Description	FbEq
	Fault	Bit 10 of 06.01 Status word1 (see page 103).	1074398721
	Fault(-1)	Bit 12 of 06.01 Status word1 (see page 103).	1074529793
	Ready relay	Bit 2 of 06.02 Status word2 (see page 104).	1073874434
	RunningRelay	Bit 3 of 06.02 Status word2 (see page 104).	1073939970
	Ref running	Bit 4 of 06.02 Status word2 (see page 104).	1074005506
	Charge ready	Bit 9 of 06.02 Status word2 (see page 104).	1074333186
	Neg speed	Bit 0 of 06.03 Speed ctrl stat (see page 105).	1073743363
	Zero speed	Bit 1 of 06.03 Speed ctrl stat (see page 105).	1073808899
	Above limit	Bit 2 of 06.03 Speed ctrl stat (see page 105).	1073874435
	At setpoint	Bit 3 of 06.03 Speed ctrl stat (see page 105).	1073939971
	Supervision1	Bit 0 of 06.13 Superv status (see page 106).	1073743373
	Supervision2	Bit 1 of 06.13 Superv status (see page 106).	1073808909
	Supervision3	Bit 2 of 06.13 Superv status (see page 106).	1073874445
	Const	Bit pointer setting (see Terms and abbreviations on page 93).	-
	Pointer		
14.30	DIO8 conf	Selects whether DIO8 is used as a digital output or input.	
	Output	DIO8 is used as a digital output.	0
	Input	DIO8 is used as a digital input.	1
14.31	DIO8 out src	Selects a drive signal to be connected to digital output DIO8 (when 14.30 DIO8 conf is set to Output).	
	Brake cmd	03.16 Brake command (see page 101).	1073742608
	Ready	Bit 0 of 06.01 Status word1 (see page 103).	1073743361
	Enabled	Bit 1 of 06.01 Status word1 (see page 103).	1073808897
	Started	Bit 2 of 06.01 Status word1 (see page 103).	1073874433
	Running	Bit 3 of 06.01 Status word1 (see page 103).	1073939969
	Alarm	Bit 7 of 06.01 Status word1 (see page 103).	1074202113
	Ext2 active	Bit 8 of 06.01 Status word1 (see page 103).	1074267649
	Fault	Bit 10 of 06.01 Status word1 (see page 103).	1074398721
	Fault(-1)	Bit 12 of 06.01 Status word1 (see page 103).	1074529793
	Ready relay	Bit 2 of 06.02 Status word2 (see page 104).	1073874434
	RunningRelay	Bit 3 of 06.02 Status word2 (see page 104).	1073939970
	Ref running	Bit 4 of 06.02 Status word2 (see page 104).	1074005506
	Charge ready	Bit 9 of 06.02 Status word2 (see page 104).	1074333186
	Neg speed	Bit 0 of 06.03 Speed ctrl stat (see page 105).	1073743363
	Zero speed	Bit 1 of 06.03 Speed ctrl stat (see page 105).	1073808899
	Above limit	Bit 2 of 06.03 Speed ctrl stat (see page 105).	1073874435
	At setpoint	Bit 3 of 06.03 Speed ctrl stat (see page 105).	1073939971
	Supervision1	Bit 0 of 06.13 Superv status (see page 106).	1073743373
	Supervision2	Bit 1 of 06.13 Superv status (see page 106).	1073808909
	Supervision3	Bit 2 of 06.13 Superv status (see page 106).	1073874445

No.	Name/Value	Description	FbEq
	Const	Bit pointer setting (see Terms and abbreviations on page 93).	-
	Pointer		
14.34	DIO9 conf	Selects whether DIO9 is used as a digital output or input.	
	Output	DIO9 is used as a digital output.	0
	Input	DIO9 is used as a digital input.	1
14.35	DIO9 out src	Selects a drive signal to be connected to digital output DIO9 (when 14.34 DIO9 conf is set to Output).	
	Brake cmd	03.16 Brake command (see page 101).	1073742608
	Ready	Bit 0 of 06.01 Status word1 (see page 103).	1073743361
	Enabled	Bit 1 of 06.01 Status word1 (see page 103).	1073808897
	Started	Bit 2 of 06.01 Status word1 (see page 103).	1073874433
	Running	Bit 3 of 06.01 Status word1 (see page 103).	1073939969
	Alarm	Bit 7 of 06.01 Status word1 (see page 103).	1074202113
	Ext2 active	Bit 8 of 06.01 Status word1 (see page 103).	1074267649
	Fault	Bit 10 of 06.01 Status word1 (see page 103).	1074398721
	Fault(-1)	Bit 12 of 06.01 Status word1 (see page 103).	1074529793
	Ready relay	Bit 2 of 06.02 Status word2 (see page 104).	1073874434
	RunningRelay	Bit 3 of 06.02 Status word2 (see page 104).	1073939970
	Ref running	Bit 4 of 06.02 Status word2 (see page 104).	1074005506
	Charge ready	Bit 9 of 06.02 Status word2 (see page 104).	1074333186
	Neg speed	Bit 0 of 06.03 Speed ctrl stat (see page 105).	1073743363
	Zero speed	Bit 1 of 06.03 Speed ctrl stat (see page 105).	1073808899
	Above limit	Bit 2 of 06.03 Speed ctrl stat (see page 105).	1073874435
	At setpoint	Bit 3 of 06.03 Speed ctrl stat (see page 105).	1073939971
	Supervision1	Bit 0 of 06.13 Superv status (see page 106).	1073743373
	Supervision2	Bit 1 of 06.13 Superv status (see page 106).	1073808909
	Supervision3	Bit 2 of 06.13 Superv status (see page 106).	1073874445
	Const	Bit pointer setting (see Terms and abbreviations on page 93).	-
	Pointer		
14.38	DIO10 conf	Selects whether DIO10 is used as a digital output or input.	
	Output	DIO10 is used as a digital output.	0
	Input	DIO10 is used as a digital input.	1
14.39	DIO10 out src	Selects a drive signal to be connected to digital output DIO10 (when 14.38 DIO10 conf is set to Output).	
	Brake cmd	03.16 Brake command (see page 101).	1073742608
	Ready	Bit 0 of 06.01 Status word1 (see page 103).	1073743361
	Enabled	Bit 1 of 06.01 Status word1 (see page 103).	1073808897
	Started	Bit 2 of 06.01 Status word1 (see page 103).	1073874433
	Running	Bit 3 of 06.01 Status word1 (see page 103).	1073939969
	Alarm	Bit 7 of 06.01 Status word1 (see page 103).	1074202113
	Ext2 active	Bit 8 of 06.01 Status word1 (see page 103).	1074267649
	Fault	Bit 10 of 06.01 Status word1 (see page 103).	1074398721

134 Parameters

No.	Name/Value	Description	FbEq
	Fault(-1)	Bit 12 of 06.01 Status word1 (see page 103).	1074529793
	Ready relay	Bit 2 of 06.02 Status word2 (see page 104).	1073874434
	RunningRelay	Bit 3 of 06.02 Status word2 (see page 104).	1073939970
	Ref running	Bit 4 of 06.02 Status word2 (see page 104).	1074005506
	Charge ready	Bit 9 of 06.02 Status word2 (see page 104).	1074333186
	Neg speed	Bit 0 of 06.03 Speed ctrl stat (see page 105).	1073743363
	Zero speed	Bit 1 of 06.03 Speed ctrl stat (see page 105).	1073808899
	Above limit	Bit 2 of 06.03 Speed ctrl stat (see page 105).	1073874435
	At setpoint	Bit 3 of 06.03 Speed ctrl stat (see page 105).	1073939971
	Supervision1	Bit 0 of 06.13 Superv status (see page 106).	1073743373
	Supervision2	Bit 1 of 06.13 Superv status (see page 106).	1073808909
	Supervision3	Bit 2 of 06.13 Superv status (see page 106).	1073874445
	Const	Bit pointer setting (see Terms and abbreviations on page 93).	-
	Pointer		
14.42	RO1 src	Selects a drive signal to be connected to relay output RO1.	
	Brake cmd	03.16 Brake command (see page 101).	1073742608
	Ready	Bit 0 of 06.01 Status word1 (see page 103).	1073743361
	Enabled	Bit 1 of 06.01 Status word1 (see page 103).	1073808897
	Started	Bit 2 of 06.01 Status word1 (see page 103).	1073874433
	Running	Bit 3 of 06.01 Status word1 (see page 103).	1073939969
	Alarm	Bit 7 of 06.01 Status word1 (see page 103).	1074202113
	Ext2 active	Bit 8 of 06.01 Status word1 (see page 103).	1074267649
	Fault	Bit 10 of 06.01 Status word1 (see page 103).	1074398721
	Fault(-1)	Bit 12 of 06.01 Status word1 (see page 103).	1074529793
	Ready relay	Bit 2 of 06.02 Status word2 (see page 104).	1073874434
	RunningRelay	Bit 3 of 06.02 Status word2 (see page 104).	1073939970
	Ref running	Bit 4 of 06.02 Status word2 (see page 104).	1074005506
	Charge ready	Bit 9 of 06.02 Status word2 (see page 104).	1074333186
	Neg speed	Bit 0 of 06.03 Speed ctrl stat (see page 105).	1073743363
	Zero speed	Bit 1 of 06.03 Speed ctrl stat (see page 105).	1073808899
	Above limit	Bit 2 of 06.03 Speed ctrl stat (see page 105).	1073874435
	At setpoint	Bit 3 of 06.03 Speed ctrl stat (see page 105).	1073939971
	Supervision1	Bit 0 of 06.13 Superv status (see page 106).	1073743373
	Supervision2	Bit 1 of 06.13 Superv status (see page 106).	1073808909
	Supervision3	Bit 2 of 06.13 Superv status (see page 106).	1073874445
	Const	Bit pointer setting (see Terms and abbreviations on page 93).	-
	Pointer		

No.	Name/Value	Description	FbEq
14.43	RO1 Ton	Defines the on (activation) delay for relay output RO1.	
<p style="text-align: center;"> t_{On} t_{Off} t_{On} t_{Off} </p> <p style="text-align: center;"> t_{On} 14.43 RO1 Ton t_{Off} 14.44 RO1 Toff </p>			
	0.0 ... 3000.0 s	On (activation) delay for RO1.	10 = 1 s
14.44	RO1 Toff	Defines the off (deactivation) delay for relay output RO1. See parameter 14.43 RO1 Ton .	
	0.0 ... 3000.0 s	Off (deactivation) delay for RO1.	10 = 1 s
14.45	RO2 src	Selects a drive signal to be connected to relay output RO2.	
	Brake cmd	03.16 Brake command (see page 101).	1073742608
	Ready	Bit 0 of 06.01 Status word1 (see page 103).	1073743361
	Enabled	Bit 1 of 06.01 Status word1 (see page 103).	1073808897
	Started	Bit 2 of 06.01 Status word1 (see page 103).	1073874433
	Running	Bit 3 of 06.01 Status word1 (see page 103).	1073939969
	Alarm	Bit 7 of 06.01 Status word1 (see page 103).	1074202113
	Ext2 active	Bit 8 of 06.01 Status word1 (see page 103).	1074267649
	Fault	Bit 10 of 06.01 Status word1 (see page 103).	1074398721
	Fault(-1)	Bit 12 of 06.01 Status word1 (see page 103).	1074529793
	Ready relay	Bit 2 of 06.02 Status word2 (see page 104).	1073874434
	RunningRelay	Bit 3 of 06.02 Status word2 (see page 104).	1073939970
	Ref running	Bit 4 of 06.02 Status word2 (see page 104).	1074005506
	Charge ready	Bit 9 of 06.02 Status word2 (see page 104).	1074333186
	Neg speed	Bit 0 of 06.03 Speed ctrl stat (see page 105).	1073743363
	Zero speed	Bit 1 of 06.03 Speed ctrl stat (see page 105).	1073808899
	Above limit	Bit 2 of 06.03 Speed ctrl stat (see page 105).	1073874435
	At setpoint	Bit 3 of 06.03 Speed ctrl stat (see page 105).	1073939971
	Supervision1	Bit 0 of 06.13 Superv status (see page 106).	1073743373
	Supervision2	Bit 1 of 06.13 Superv status (see page 106).	1073808909
	Supervision3	Bit 2 of 06.13 Superv status (see page 106).	1073874445
	Const	Bit pointer setting (see Terms and abbreviations on page 93).	-
	Pointer		

No.	Name/Value	Description	FbEq
14.48	RO3 src	Selects a drive signal to be connected to relay output RO3.	
	Brake cmd	03.16 Brake command (see page 101).	1073742608
	Ready	Bit 0 of 06.01 Status word1 (see page 103).	1073743361
	Enabled	Bit 1 of 06.01 Status word1 (see page 103).	1073808897
	Started	Bit 2 of 06.01 Status word1 (see page 103).	1073874433
	Running	Bit 3 of 06.01 Status word1 (see page 103).	1073939969
	Alarm	Bit 7 of 06.01 Status word1 (see page 103).	1074202113
	Ext2 active	Bit 8 of 06.01 Status word1 (see page 103).	1074267649
	Fault	Bit 10 of 06.01 Status word1 (see page 103).	1074398721
	Fault(-1)	Bit 12 of 06.01 Status word1 (see page 103).	1074529793
	Ready relay	Bit 2 of 06.02 Status word2 (see page 104).	1073874434
	RunningRelay	Bit 3 of 06.02 Status word2 (see page 104).	1073939970
	Ref running	Bit 4 of 06.02 Status word2 (see page 104).	1074005506
	Charge ready	Bit 9 of 06.02 Status word2 (see page 104).	1074333186
	Neg speed	Bit 0 of 06.03 Speed ctrl stat (see page 105).	1073743363
	Zero speed	Bit 1 of 06.03 Speed ctrl stat (see page 105).	1073808899
	Above limit	Bit 2 of 06.03 Speed ctrl stat (see page 105).	1073874435
	At setpoint	Bit 3 of 06.03 Speed ctrl stat (see page 105).	1073939971
	Supervision1	Bit 0 of 06.13 Superv status (see page 106).	1073743373
	Supervision2	Bit 1 of 06.13 Superv status (see page 106).	1073808909
	Supervision3	Bit 2 of 06.13 Superv status (see page 106).	1073874445
	Const	Bit pointer setting (see Terms and abbreviations on page 93).	-
	Pointer		
14.51	RO4 src	Selects a drive signal to be connected to relay output RO4.	
	Const	Bit pointer setting (see Terms and abbreviations on page 93).	-
	Pointer		
14.54	RO5 src	Selects a drive signal to be connected to relay output RO5.	
	Const	Bit pointer setting (see Terms and abbreviations on page 93).	-
	Pointer		

No.	Name/Value	Description	FbEq
14.57	Freq in max	<p>Defines the maximum input frequency for DIO2 when parameter 14.06 DIO2 conf is set to <i>Freq input</i>.</p>	
	3 ... 32768 Hz	DIO2 maximum frequency.	1 = 1 Hz
14.58	Freq in min	<p>Defines the minimum input frequency for DIO2 when parameter 14.06 DIO2 conf is set to <i>Freq input</i>. (See diagram at parameter 14.57 Freq in max.)</p>	
	3 ... 32768 Hz	DIO2 minimum frequency.	1 = 1 Hz
14.59	Freq in max scal	<p>Defines the real value that corresponds to the maximum input frequency defined by parameter 14.57 Freq in max. (See diagram at parameter 14.57 Freq in max.)</p>	
	-32768 ... 32768	Real value corresponding to DIO2 maximum frequency.	1 = 1
14.60	Freq in min scal	<p>Defines the real value that corresponds to the minimum input frequency defined by 14.58 Freq in min. (See diagram at parameter 14.57 Freq in max.)</p>	
	-32768 ... 32768	Real value corresponding to DIO2 minimum frequency.	1 = 1
14.61	Freq out src	<p>Selects a drive signal to be connected to frequency output DIO3 (when 14.10 DIO3 conf is set to <i>Freq output</i>).</p>	
		Value pointer setting (see Terms and abbreviations on page 93).	-

No.	Name/Value	Description	FbEq
14.62	Freq out max src	<p>When 14.10 DIO3 conf is set to <i>Freq output</i>, defines the real value of the signal (selected by parameter 14.61 Freq out src) that corresponds to the maximum DIO3 frequency output value (defined by parameter 14.64 Freq out max sca).</p> <p>The top graph shows the frequency f_{DIO3} (Hz) on the y-axis and the signal value on the x-axis. The signal value starts at 14.63 and increases to 14.62. The frequency starts at 14.65 and increases to 14.64. The bottom graph shows the frequency f_{DIO3} (Hz) on the y-axis and the signal value on the x-axis. The signal value starts at 14.62 and increases to 14.63. The frequency starts at 14.64 and decreases to 14.65.</p>	
	0 ... 32768	Real signal value corresponding to maximum DIO3 output frequency.	1 = 1
14.63	Freq out min src	When 14.10 DIO3 conf is set to <i>Freq output</i> , defines the real value of the signal (selected by parameter 14.61 Freq out src) that corresponds to the minimum DIO3 frequency output value (defined by parameter 14.65 Freq out min sca).	
	0 ... 32768	Real signal value corresponding to minimum DIO3 output frequency.	1 = 1
14.64	Freq out max sca	When 14.10 DIO3 conf is set to <i>Freq output</i> , defines the maximum DIO3 output frequency.	
	3 ... 32768 Hz	Maximum DIO3 output frequency.	1 = 1 Hz
14.65	Freq out min sca	When 14.10 DIO3 conf is set to <i>Freq output</i> , defines the minimum DIO3 output frequency.	
	3 ... 32768 Hz	Minimum DIO3 output frequency.	1 = 1 Hz
14.67	RO6 src	Selects a drive signal to be connected to relay output RO6.	
	Const	Bit pointer setting (see Terms and abbreviations on page 93).	-
	Pointer		
14.70	RO7 src	Selects a drive signal to be connected to relay output RO7.	
	Const	Bit pointer setting (see Terms and abbreviations on page 93).	-
	Pointer		

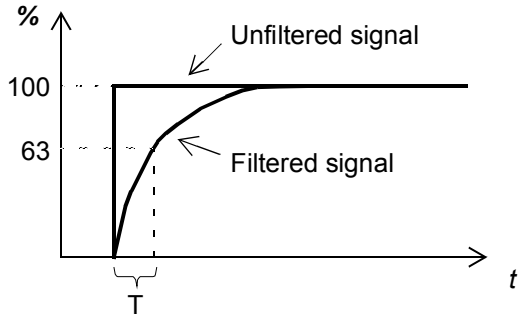
No.	Name/Value	Description	FbEq
15 Analogue outputs		Selection and processing of actual signals to be indicated through the analogue outputs. See section Programmable analog outputs on page 72.	
15.01	AO1 src	Selects a drive signal to be connected to analogue output AO1.	
	Speed rpm	01.01 Motor speed rpm (see page 94).	1073742081
	Speed %	01.02 Motor speed % (see page 94).	1073742082
	Frequency	01.03 Output frequency (see page 94).	1073742083
	Current	01.04 Motor current (see page 94).	1073742084
	Current %	01.05 Motor current % (see page 94).	1073742085
	Torque	01.06 Motor torque (see page 94).	1073742086
	Dc-voltage	01.07 Dc-voltage (see page 94).	1073742087
	Power inu	01.22 Power inu out (see page 94).	1073742102
	Power motor	01.23 Motor power (see page 94).	1073742103
	SpRef unramp	03.03 SpeedRef unramp (see page 101).	1073742595
	SpRef ramped	03.05 SpeedRef ramped (see page 101).	1073742597
	SpRef used	03.06 SpeedRef used (see page 101).	1073742598
	TorqRef used	03.14 Torq ref used (see page 101).	1073742606
	Process act	04.03 Process act (see page 102).	1073742851
	Proc PID out	04.05 Process PID out (see page 102).	1073742853
	Pointer	Value pointer setting (see Terms and abbreviations on page 93).	-
15.02	AO1 filt time	<p>Defines the filtering time constant for analogue output AO1.</p>  <p style="text-align: center;">$O = I \times (1 - e^{-t/T})$</p> <p>I = filter input (step) O = filter output t = time T = filter time constant</p>	
	0.000 ... 30.000 s	Filter time constant.	1000 = 1 s
15.03	AO1 out max	Defines the maximum output value for analogue output AO1.	
	0.000 ... 22.700 mA	Maximum AO1 output value.	1000 = 1 mA
15.04	AO1 out min	Defines the minimum output value for analogue output AO1.	
	0.000 ... 22.700 mA	Minimum AO1 output value.	1000 = 1 mA

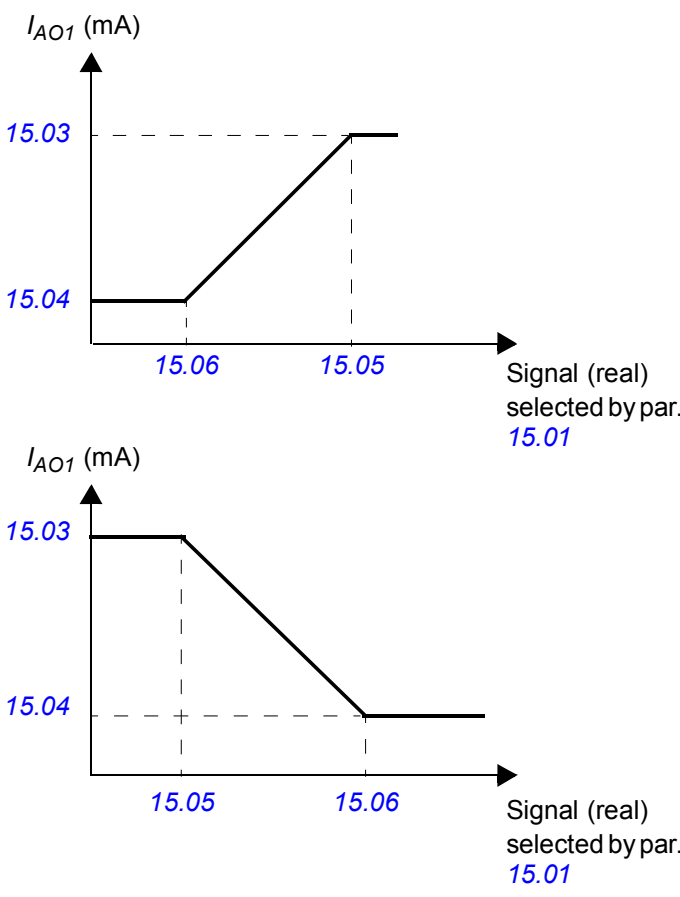
No.	Name/Value	Description	FbEq
15.05	AO1 src max	<p>Defines the real value of the signal (selected by parameter 15.01 AO1 src) that corresponds to the maximum AO1 output value (defined by parameter 15.03 AO1 out max).</p>  <p>The figure contains two graphs. Both graphs have I_{AO1} (mA) on the vertical axis and 'Signal (real) selected by par. 15.01' on the horizontal axis. The top graph shows a signal value increasing from 15.06 to 15.05, with the output current I_{AO1} increasing from 15.04 mA to 15.03 mA. The bottom graph shows a signal value increasing from 15.05 to 15.06, with the output current I_{AO1} decreasing from 15.03 mA to 15.04 mA.</p>	
	-32768.000 ... 32768.000	Real signal value corresponding to maximum AO1 output value.	1000 = 1
15.06	AO1 src min	Defines the real value of the signal (selected by parameter 15.01 AO1 src) that corresponds to the minimum AO1 output value (defined by parameter 15.04 AO1 out min). See parameter 15.05 AO1 src max .	
	-32768.000 ... 32768.000	Real signal value corresponding to minimum AO1 output value.	1000 = 1
15.07	AO2 src	Selects a drive signal to be connected to analogue output AO2.	
	Speed rpm	01.01 Motor speed rpm (see page 94).	1073742081
	Speed %	01.02 Motor speed % (see page 94).	1073742082
	Frequency	01.03 Output frequency (see page 94).	1073742083
	Current	01.04 Motor current (see page 94).	1073742084
	Current %	01.05 Motor current % (see page 94).	1073742085
	Torque	01.06 Motor torque (see page 94).	1073742086
	Dc-voltage	01.07 Dc-voltage (see page 94).	1073742087
	Power inu	01.22 Power inu out (see page 94).	1073742102
	Power motor	01.23 Motor power (see page 94).	1073742103
	SpRef unramp	03.03 SpeedRef unramp (see page 101).	1073742595

No.	Name/Value	Description	FbEq
	SpRef ramped	03.05 SpeedRef ramped (see page 101).	1073742597
	SpRef used	03.06 SpeedRef used (see page 101).	1073742598
	TorqRef used	03.14 Torq ref used (see page 101).	1073742606
	Process act	04.03 Process act (see page 102).	1073742851
	Proc PID out	04.05 Process PID out (see page 102).	1073742853
	Pointer	Value pointer setting (see Terms and abbreviations on page 93).	-
15.08	AO2 filt time	Defines the filtering time constant for analogue output AO2. See parameter 15.02 AO1 filt time .	
	0.000 ... 30.000 s	Filter time constant.	1000 = 1 s
15.09	AO2 out max	Defines the maximum output value for analogue output AO2.	
	0.000 ... 22.700 mA	Maximum AO2 output value.	1000 = 1 mA
15.10	AO2 out min	Defines the minimum output value for analogue output AO2.	
	0.000 ... 22.700 mA	Minimum AO2 output value.	1000 = 1 mA
15.11	AO2 src max	Defines the real value of the signal (selected by parameter 15.07 AO2 src) that corresponds to the maximum AO2 output value (defined by parameter 15.09 AO2 out max).	
		<p>The figure contains two graphs. Both graphs have I_{AO2} (mA) on the vertical axis and 'Signal (real) selected by par. 15.07' on the horizontal axis. The top graph shows a signal increasing from 15.12 to 15.11, with the AO2 current increasing from 15.10 to 15.09. The bottom graph shows a signal decreasing from 15.11 to 15.12, with the AO2 current decreasing from 15.09 to 15.10.</p>	
	-32768.000 ... 32768.000	Real signal value corresponding to maximum AO2 output value.	1000 = 1

142 Parameters

No.	Name/Value	Description	FbEq
15.12	AO2 src min	Defines the real value of the signal (selected by parameter 15.07 AO2 src) that corresponds to the minimum AO1 output value (defined by parameter 15.10 AO2 out min). See parameter 15.11 AO2 src max .	
	-32768.000 ... 32768.000	Real signal value corresponding to minimum AO2 output value.	1000 = 1
15.13	AO3 src	Selects a drive signal to be connected to analogue output AO3.	
	Speed rpm	01.01 Motor speed rpm (see page 94).	1073742081
	Speed %	01.02 Motor speed % (see page 94).	1073742082
	Frequency	01.03 Output frequency (see page 94).	1073742083
	Current	01.04 Motor current (see page 94).	1073742084
	Current %	01.05 Motor current % (see page 94).	1073742085
	Torque	01.06 Motor torque (see page 94).	1073742086
	Dc-voltage	01.07 Dc-voltage (see page 94).	1073742087
	Power inu	01.22 Power inu out (see page 94).	1073742102
	Power motor	01.23 Motor power (see page 94).	1073742103
	SpRef unramp	03.03 SpeedRef unramp (see page 101).	1073742595
	SpRef ramped	03.05 SpeedRef ramped (see page 101).	1073742597
	SpRef used	03.06 SpeedRef used (see page 101).	1073742598
	TorqRef used	03.14 Torq ref used (see page 101).	1073742606
	Process act	04.03 Process act (see page 102).	1073742851
	Proc PID out	04.05 Process PID out (see page 102).	1073742853
	Pointer	Value pointer setting (see Terms and abbreviations on page 93).	-
15.14	AO3 filt time	Defines the filtering time constant for analogue output AO3. See parameter 15.02 AO1 filt time .	
	0.000 ... 30.000 s	Filter time constant.	1000 = 1 s
15.15	AO3 out max	Defines the maximum output value for analogue output AO3.	
	0.000 ... 22.700 mA	Maximum AO3 output value.	1000 = 1 mA
15.16	AO3 out min	Defines the minimum output value for analogue output AO3.	
	0.000 ... 22.700 mA	Minimum AO3 output value.	1000 = 1 mA

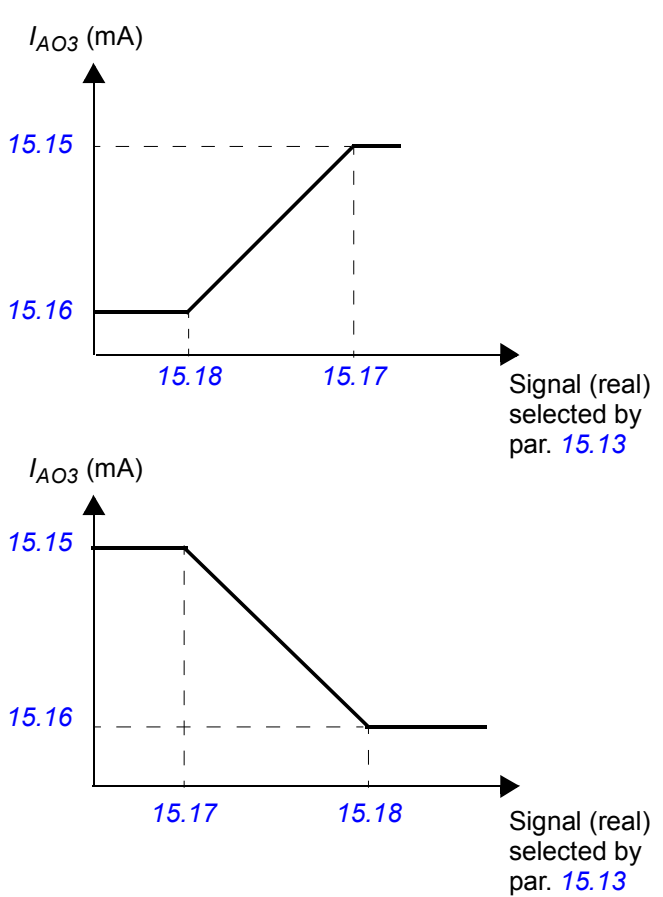
No.	Name/Value	Description	FbEq
15.17	AO3 src max	<p>Defines the real value of the signal (selected by parameter 15.13 AO3 src) that corresponds to the maximum AO3 output value (defined by parameter 15.15 AO3 out max).</p> 	
	-32768.000 ... 32768.000	Real signal value corresponding to maximum AO3 output value.	1000 = 1
15.18	AO3 src min	<p>Defines the real value of the signal (selected by parameter 15.13 AO3 src) that corresponds to the minimum AO3 output value (defined by parameter 15.16 AO3 out min). See parameter 15.17 AO3 src max.</p>	
	-32768.000 ... 32768.000	Real signal value corresponding to minimum AO3 output value.	1000 = 1
15.19	AO4 src	Selects a drive signal to be connected to analogue output AO4.	
	Speed rpm	01.01 Motor speed rpm (see page 94).	1073742081
	Speed %	01.02 Motor speed % (see page 94).	1073742082
	Frequency	01.03 Output frequency (see page 94).	1073742083
	Current	01.04 Motor current (see page 94).	1073742084
	Current %	01.05 Motor current % (see page 94).	1073742085
	Torque	01.06 Motor torque (see page 94).	1073742086
	Dc-voltage	01.07 Dc-voltage (see page 94).	1073742087
	Power inu	01.22 Power inu out (see page 94).	1073742102
	Power motor	01.23 Motor power (see page 94).	1073742103
	SpRef unramp	03.03 SpeedRef unramp (see page 101).	1073742595

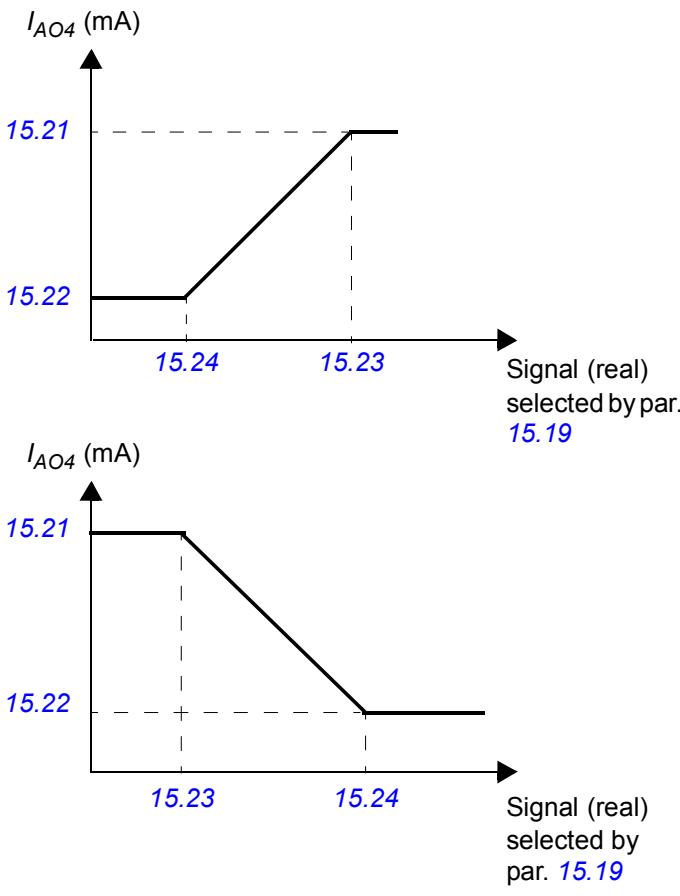
No.	Name/Value	Description	FbEq
	SpRef ramped	03.05 SpeedRef ramped (see page 101).	1073742597
	SpRef used	03.06 SpeedRef used (see page 101).	1073742598
	TorqRef used	03.14 Torq ref used (see page 101).	1073742606
	Process act	04.03 Process act (see page 102).	1073742851
	Proc PID out	04.05 Process PID out (see page 102).	1073742853
	Pointer	Value pointer setting (see Terms and abbreviations on page 93).	-
15.20	AO4 filt time	Defines the filtering time constant for analogue output AO4. See parameter 15.02 AO1 filt time .	
	0.000 ... 30.000 s	Filter time constant.	1000 = 1 s
15.21	AO4 out max	Defines the maximum output value for analogue output AO4.	
	0.000 ... 22.700 mA	Maximum AO4 output value.	1000 = 1 mA
15.22	AO4 out min	Defines the minimum output value for analogue output AO4.	
	0.000 ... 22.700 mA	Minimum AO4 output value.	1000 = 1 mA
15.23	AO4 src max	<p>Defines the real value of the signal (selected by parameter 15.19 AO4 src) that corresponds to the maximum AO4 output value (defined by parameter 15.21 AO4 out max).</p>  <p>The figure contains two graphs. Both graphs have I_{AO4} (mA) on the vertical axis and 'Signal (real) selected by par. 15.19' on the horizontal axis. The top graph shows a signal that is constant at 15.22 mA until parameter 15.24, then ramps up to 15.21 mA at parameter 15.23, and remains constant thereafter. The bottom graph shows a signal that is constant at 15.21 mA until parameter 15.23, then ramps down to 15.22 mA at parameter 15.24, and remains constant thereafter.</p>	
	-32768.000 ... 32768.000	Real signal value corresponding to maximum AO4 output value.	1000 = 1

No.	Name/Value	Description	FbEq											
15.24	AO4 src min	Defines the real value of the signal (selected by parameter 15.19 AO4 src) that corresponds to the minimum AO4 output value (defined by parameter 15.22 AO4 out min). See parameter 15.23 AO4 src max .												
	-32768.000 ... 32768.000	Real signal value corresponding to minimum AO4 output value.	1000 = 1											
15.25	AO ctrl word	Defines how a signed source is processed before output.												
		<table border="1"> <thead> <tr> <th>Bit</th> <th>Name</th> <th>Information</th> </tr> </thead> <tbody> <tr> <td rowspan="2">0</td> <td rowspan="2">AO1 func</td> <td>1 = AO1 is bipolar</td> </tr> <tr> <td>0 = AO1 is absolute value of source</td> </tr> <tr> <td rowspan="2">1</td> <td rowspan="2">AO2 func</td> <td>1 = AO2 is bipolar</td> </tr> <tr> <td>0 = AO2 is absolute value of source</td> </tr> </tbody> </table>	Bit	Name	Information	0	AO1 func	1 = AO1 is bipolar	0 = AO1 is absolute value of source	1	AO2 func	1 = AO2 is bipolar	0 = AO2 is absolute value of source	
Bit	Name	Information												
0	AO1 func	1 = AO1 is bipolar												
		0 = AO1 is absolute value of source												
1	AO2 func	1 = AO2 is bipolar												
		0 = AO2 is absolute value of source												

16 System		Parameter lock, parameter restore, user parameter sets etc.	
16.01	Local lock	<p>Selects the source for disabling local control (Take/Release button in the PC tool, LOC/REM key of the panel).</p> <p>0 = Local control enabled. 1 = Local control disabled.</p> <p> WARNING! Before activating, ensure that the control panel is not needed for stopping the drive!</p>	
	Const	Bit pointer setting (see Terms and abbreviations on page 93).	-
	Pointer		
16.02	Parameter lock	Selects the state of the parameter lock. The lock prevents parameter changing.	
	Locked	Locked. Parameter values cannot be changed from the control panel. The lock can be opened by entering the valid code into parameter 16.03 Pass code .	0
	Open	The lock is open. Parameter values can be changed.	1
	Not saved	The lock is open. Parameter values can be changed, but the changes will not be stored at power switch-off.	2
16.03	Pass code	Selects the pass code for the parameter lock (see parameter 16.02 Parameter lock). After entering 358 at this parameter, parameter 16.02 Parameter lock can be adjusted. The value reverts back to 0 automatically.	
	0 ... 2147483647	Pass code for parameter lock.	1 = 1
16.04	Param restore	Restores the original settings of the application, i.e. parameter factory default values. Note: This parameter cannot be changed while the drive is running.	
	Done	Restoring is completed.	0
	Restore defs	All parameter values are restored to default values, except motor data, ID run results, and fieldbus, drive-to-drive link and encoder configuration data.	1
	Clear all	All parameter values are restored to default values, including motor data, ID run results and fieldbus and encoder configuration data. PC tool communication is interrupted during the restoring. Drive CPU is re-booted after the restoring is completed.	2

No.	Name/Value	Description	FbEq
16.07	Param save	Saves the valid parameter values to the permanent memory. Note: A new parameter value is saved automatically when changed from the PC tool or panel but not when altered through a fieldbus connection.	
	Done	Save completed.	0
	Save	Save in progress.	1
16.09	User set sel	Enables the saving and restoring of up to four custom sets of parameter settings. The set that was in use before powering down the drive is in use after the next power-up. Notes: <ul style="list-style-type: none"> Fieldbus and encoder parameters (groups 50-53 and 90-93 respectively) are not part of the user parameter sets. Any parameter changes made after loading a set are not automatically stored – they must be saved using this parameter. 	
	No request	Load or save operation complete; normal operation.	1
	Load set 1	Load user parameter set 1.	2
	Load set 2	Load user parameter set 2.	3
	Load set 3	Load user parameter set 3.	4
	Load set 4	Load user parameter set 4.	5
	Save set 1	Save user parameter set 1.	6
	Save set 2	Save user parameter set 2.	7
	Save set 3	Save user parameter set 3.	8
	Save set 4	Save user parameter set 4.	9
	IO mode	Load user parameter set using parameters 16.11 User IO sel lo and 16.12 User IO sel hi .	10
16.10	User set log	Shows the status of the user parameter sets (see parameter 16.09 User set sel). Read-only.	
	N/A	No user sets have been saved.	0
	Loading	A user set is being loaded.	1
	Saving	A user set is being saved.	2
	Faulted	Invalid or empty parameter set.	4
	Set1 IO act	User parameter set 1 has been selected by parameters 16.11 User IO sel lo and 16.12 User IO sel hi .	8
	Set2 IO act	User parameter set 2 has been selected by parameters 16.11 User IO sel lo and 16.12 User IO sel hi .	16
	Set3 IO act	User parameter set 3 has been selected by parameters 16.11 User IO sel lo and 16.12 User IO sel hi .	32
	Set4 IO act	User parameter set 4 has been selected by parameters 16.11 User IO sel lo and 16.12 User IO sel hi .	64
	Set1 par act	User parameter set 1 has been loaded using parameter 16.09 User set sel .	128
	Set2 par act	User parameter set 2 has been loaded using parameter 16.09 User set sel .	256
	Set3 par act	User parameter set 3 has been loaded using parameter 16.09 User set sel .	512

No.	Name/Value	Description	FbEq															
	Set4 par act	User parameter set 4 has been loaded using parameter 16.09 User set sel .	1024															
16.11	User IO sel lo	When parameter 16.09 User set sel is set to <i>IO mode</i> , selects the user parameter set together with parameter 16.12 User IO sel hi . The status of the source defined by this parameter and parameter 16.12 select the user parameter set as follows: <table border="1" data-bbox="548 448 1254 761"> <thead> <tr> <th>Status of source defined by par. 16.11</th> <th>Status of source defined by par. 16.12</th> <th>User parameter set selected</th> </tr> </thead> <tbody> <tr> <td>FALSE</td> <td>FALSE</td> <td>Set 1</td> </tr> <tr> <td>TRUE</td> <td>FALSE</td> <td>Set 2</td> </tr> <tr> <td>FALSE</td> <td>TRUE</td> <td>Set 3</td> </tr> <tr> <td>TRUE</td> <td>TRUE</td> <td>Set 4</td> </tr> </tbody> </table>	Status of source defined by par. 16.11	Status of source defined by par. 16.12	User parameter set selected	FALSE	FALSE	Set 1	TRUE	FALSE	Set 2	FALSE	TRUE	Set 3	TRUE	TRUE	Set 4	
Status of source defined by par. 16.11	Status of source defined by par. 16.12	User parameter set selected																
FALSE	FALSE	Set 1																
TRUE	FALSE	Set 2																
FALSE	TRUE	Set 3																
TRUE	TRUE	Set 4																
	Const	Bit pointer setting (see Terms and abbreviations on page 93).	-															
	Pointer																	
16.12	User IO sel hi	See parameter 16.11 User IO sel lo .																
	Const	Bit pointer setting (see Terms and abbreviations on page 93).	-															
	Pointer																	
16.14	Reset ChgParLog	Resets the log of latest parameter changes.																
	Done	Reset not requested (normal operation).	0															
	Reset	Reset log of latest parameter changes. The value reverts automatically to <i>Done</i> .	1															
16.15	Menu set sel	Loads a short, long or custom parameter list. By default, short parameter list is displayed by drive.																
	No request	No change has been requested.	0															
	Load short	Load short parameter list. Only a selective list of parameters will be displayed.	1															
	Load long	Load long parameter list. All parameters will be displayed.	2															
16.16	Menu set active	Shows which parameter list is active. See parameter 16.15 Menu set sel .																
	None	No parameter list is active.	0															
	Short menu	Short parameter list is active.	1															
	Long menu	Long parameter list is active. All parameters are displayed.	2															
16.17	Power unit	Selects the unit of power for parameters such as 01.22 Power inu out , 01.23 Motor power and 99.10 Mot nom power .																
	kW	Kilowatt.	0															
	hp	Horsepower.	1															
19 Speed calculation		Speed feedback, speed window, etc. settings.																
19.01	Speed scaling	Defines the terminal speed value used in acceleration and the initial speed value used in deceleration (see parameter group 22 Speed ref ramp). Also defines the rpm value that corresponds to 20000 for fieldbus communication with ABB Drives communication profile.																
	0 ... 30000 rpm	Acceleration/deceleration terminal/initial speed.	1 = 1 rpm															

No.	Name/Value	Description	FbEq
19.02	Speed fb sel	Selects the speed feedback value used in control.	
	Estimated	A calculated speed estimate is used.	0
	Enc1 speed	Actual speed measured with encoder 1. The encoder is selected by parameter 90.01 Encoder 1 sel.	1
	Enc2 speed	Actual speed measured with encoder 2. The encoder is selected by parameter 90.02 Encoder 2 sel.	2
19.03	MotorSpeed filt	<p>Defines the time constant of the actual speed filter, i.e. time within the actual speed has reached 63% of the nominal speed (filtered speed = 01.01 Motor speed rpm).</p> <p>If the used speed reference remains constant, the possible interferences in the speed measurement can be filtered with the actual speed filter. Reducing the ripple with filter may cause speed controller tuning problems. A long filter time constant and fast acceleration time contradict one another. A very long filter time results in unstable control.</p> <p>If there are substantial interferences in the speed measurement, the filter time constant should be proportional to the total inertia of the load and motor, in this case 10...30% of the mechanical time constant</p> $t_{\text{mech}} = (n_{\text{nom}} / T_{\text{nom}}) \times J_{\text{tot}} \times 2\pi / 60$, where J_{tot} = total inertia of the load and motor (the gear ratio between the load and motor must be taken into account) n_{nom} = motor nominal speed T_{nom} = motor nominal torque See also parameter 23.07 Speed err Ftime .	
	0.000 ... 10000.000 ms	Time constant of the actual speed filter.	1000 = 1 ms
19.06	Zero speed limit	Defines the zero speed limit. The motor is stopped along a speed ramp until the defined zero speed limit is reached. After the limit, the motor coasts to stop.	
	0.00 ... 30000.00 rpm	Zero speed limit.	100 = 1 rpm

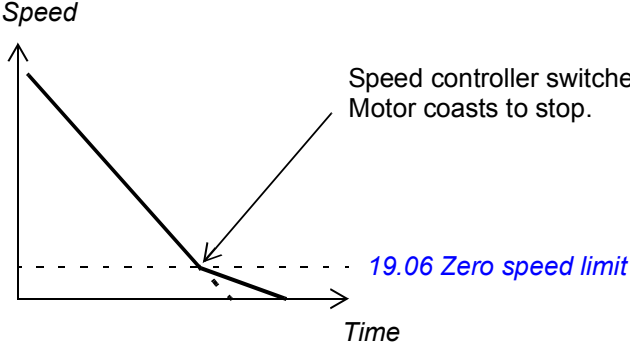
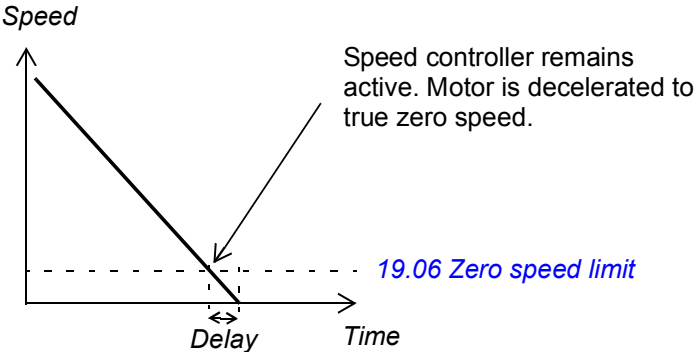
No.	Name/Value	Description	FbEq
19.07	Zero speed delay	<p>Defines the delay for the zero speed delay function. The function is useful in applications where a smooth and quick restarting is essential. During the delay, the drive knows accurately the rotor position.</p> <p>Without Zero Speed Delay: The drive receives a stop command and decelerates along a ramp. When the motor actual speed falls below an internal limit (called Zero Speed Limit), the speed controller is switched off. The inverter modulation is stopped and the motor coasts to standstill.</p>  <p>With Zero Speed Delay: The drive receives a stop command and decelerates along a ramp. When the actual motor speed falls below an internal limit (called Zero Speed Limit), the zero speed delay function activates. During the delay the function keeps the speed controller live: the inverter modulates, motor is magnetised and the drive is ready for a quick restart. Zero speed delay can be used e.g. with the jogging function.</p> 	
	0 ... 30000 ms	Zero speed delay.	1 = 1 ms
19.08	Above speed lim	Defines the supervision limit for the actual speed.	
	0 ... 30000 rpm	Actual speed supervision limit.	1 = 1 rpm

No.	Name/Value	Description	FbEq
19.09	Speed TripMargin	<p>Defines, together with 20.01 Maximum speed and 20.02 Minimum speed, the maximum allowed speed of the motor (overspeed protection). If actual speed (01.01 Motor speed rpm) exceeds the speed limit defined by parameter 20.01 or 20.02 by more than the value of this parameter, the drive trips on the OVERSPEED fault.</p> <p>Example: If the maximum speed is 1420 rpm and speed trip margin is 300 rpm, the drive trips at 1720 rpm.</p>	
	0.0 ... 10000.0 rpm	Overspeed trip margin.	10 = 1 rpm
19.10	Speed window	<p>Defines the absolute value for the motor speed window supervision, i.e. the absolute value for the difference between the actual speed and the unramped speed reference (01.01 Motor speed rpm - 03.03 SpeedRef unramp). When the motor speed is within the limits defined by this parameter, signal 02.24 FBA main sw bit 8 (AT_SETPOINT) is 1. If the motor speed is not within the defined limits, bit 8 is 0.</p>	
	0 ... 30000 rpm	Absolute value for motor speed window supervision.	1 = 1 rpm
20 Limits		Drive operation limits. See also section Speed controller tuning on page 74.	
20.01	Maximum speed	Defines the allowed maximum speed.	
	0 ... 30000 rpm	Maximum speed.	1 = 1 rpm
20.02	Minimum speed	Defines the allowed minimum speed.	
	-30000 ... 0 rpm	Minimum speed.	1 = 1 rpm

No.	Name/Value	Description	FbEq
20.03	Pos speed ena	<p>Selects the source of the positive speed reference enable command.</p> <p>1 = Positive speed reference is enabled. 0 = Positive speed reference is interpreted as zero speed reference (In the figure below 03.03 SpeedRef unramp is set to zero after the positive speed enable signal has cleared).</p> <p>Actions in different control modes: Speed control: Speed reference is set to zero and the motor is stopped along the currently active deceleration ramp. Torque control: Torque limit is set to zero and the rush controller stops the motor.</p>	
		<p>Example: The motor is rotating in the forward direction. To stop the motor, the positive speed enable signal is deactivated by a hardware limit switch (e.g. via digital input). If the positive speed enable signal remains deactivated and the negative speed enable signal is active, only reverse rotation of the motor is allowed.</p>	
	Const	Bit pointer setting (see Terms and abbreviations on page 93).	-
	Pointer		
20.04	Neg speed ena	Selects the source of the negative speed reference enable command. See parameter 20.03 Pos speed ena .	
	Const	Bit pointer setting (see Terms and abbreviations on page 93).	-
	Pointer		
20.05	Maximum current	Defines the maximum allowed motor current.	
	0.00 ... 30000.00 A	Maximum motor current.	100 = 1 A
20.06	Torq lim sel	<p>Defines a source that selects between the two sets of torque limits defined by parameters 20.07...20.10.</p> <p>0 = The torque limits defined by parameters 20.07 Maximum torque1 and 20.08 Minimum torque1 are in force. 1 = The torque limits defined by parameters 20.09 Maximum torque2 and 20.10 Minimum torque2 are in force.</p>	
	Const	Bit pointer setting (see Terms and abbreviations on page 93).	-
	Pointer		
20.07	Maximum torque1	Defines maximum torque limit 1 for the drive (in percent of the motor nominal torque). See parameter 20.06 Torq lim sel .	
	0.0 ... 1600.0%	Maximum torque 1.	10 = 1%

152 Parameters

No.	Name/Value	Description	FbEq
20.08	Minimum torque1	Defines minimum torque limit 1 for the drive (in percent of the motor nominal torque). See parameter 20.06 Torq lim sel .	
	-1600.0 ... 0.0%	Minimum torque 1.	10 = 1%
20.09	Maximum torque2	Defines maximum torque limit 2 for the drive (in percent of the motor nominal torque). See parameter 20.06 Torq lim sel .	
	AI1 scaled	02.05 AI1 scaled (see page 95).	1073742341
	AI2 scaled	02.07 AI2 scaled (see page 95).	1073742343
	FBA ref1	02.26 FBA main ref1 (see page 100).	1073742362
	FBA ref2	02.27 FBA main ref2 (see page 100).	1073742363
	D2D ref1	02.32 D2D ref1 (see page 101).	1073742368
	D2D ref2	02.33 D2D ref2 (see page 101).	1073742369
	PID out	04.05 Process PID out (see page 102).	1073742853
	Max torque1	20.07 Maximum torque1 (see page 151).	1073746951
	Pointer	Value pointer setting (see Terms and abbreviations on page 93).	-
20.10	Minimum torque2	Defines minimum torque limit 2 for the drive (in percent of the motor nominal torque). See parameter 20.06 Torq lim sel .	
	AI1 scaled	02.05 AI1 scaled (see page 95).	1073742341
	AI2 scaled	02.07 AI2 scaled (see page 95).	1073742343
	FBA ref1	02.26 FBA main ref1 (see page 100).	1073742362
	FBA ref2	02.27 FBA main ref2 (see page 100).	1073742363
	D2D ref1	02.32 D2D ref1 (see page 101).	1073742368
	D2D ref2	02.33 D2D ref2 (see page 101).	1073742369
	PID out	04.05 Process PID out (see page 102).	1073742853
	Min torque1	20.08 Minimum torque1 (see page 152).	1073746952
	Pointer	Value pointer setting (see Terms and abbreviations on page 93).	-
20.12	P motoring lim	Defines the maximum allowed power fed by the inverter to the motor in percent of the motor nominal power.	
	0.0 ... 1600.0%	Maximum motoring power.	10 = 1%
20.13	P generating lim	Defines the maximum allowed power fed by the motor to the inverter in percent of the motor nominal power.	
	0.0 ... 1600.0%	Maximum generating power.	10 = 1%
21 Speed ref		Speed reference source and scaling settings; motor potentiometer settings.	
21.01	Speed ref1 sel	Selects the source for speed reference 1. See also parameter 21.03 Speed ref1 func .	
	Zero	Zero speed reference.	0
	AI1 scaled	02.05 AI1 scaled (see page 95).	1073742341
	AI2 scaled	02.07 AI2 scaled (see page 95).	1073742343
	Freq in	02.20 Freq in (see page 96).	1073742356
	FBA ref1	02.26 FBA main ref1 (see page 100).	1073742362
	FBA ref2	02.27 FBA main ref2 (see page 100).	1073742363
	D2D ref1	02.32 D2D ref1 (see page 101).	1073742368

No.	Name/Value	Description	FbEq
	D2D ref2	02.33 D2D ref2 (see page 101).	1073742369
	Panel	02.34 Panel ref (see page 101).	1073742370
	Mot pot	03.18 Speed ref pot (see page 101).	1073742610
	PID out	04.05 Process PID out (see page 102).	1073742853
	Pointer	Value pointer setting (see Terms and abbreviations on page 93).	-
21.02	Speed ref2 sel	Selects the source for speed reference 2.	
	Zero	Zero speed reference.	0
	AI1 scaled	02.05 AI1 scaled (see page 95).	1073742341
	AI2 scaled	02.07 AI2 scaled (see page 95).	1073742343
	Freq in	02.20 Freq in (see page 96).	1073742356
	FBA ref1	02.26 FBA main ref1 (see page 100).	1073742362
	FBA ref2	02.27 FBA main ref2 (see page 100).	1073742363
	D2D ref1	02.32 D2D ref1 (see page 101).	1073742368
	D2D ref2	02.33 D2D ref2 (see page 101).	1073742369
	Panel	02.34 Panel ref (see page 101).	1073742370
	Mot pot	03.18 Speed ref pot (see page 101).	1073742610
	PID out	04.05 Process PID out (see page 102).	1073742853
	Pointer	Value pointer setting (see Terms and abbreviations on page 93).	-
21.03	Speed ref1 func	Selects a mathematical function between the reference sources selected by parameters 21.01 Speed ref1 sel and 21.02 Speed ref2 sel to be used as speed reference 1.	
	Ref1	Signal selected by 21.01 Speed ref1 sel is used as speed reference 1 as such.	0
	Add	The sum of the reference sources is used as speed reference 1.	1
	Sub	The subtraction ($[\text{21.01 Speed ref1 sel}] - [\text{21.02 Speed ref2 sel}]$) of the reference sources is used as speed reference 1.	2
	Mul	The multiplication of the reference sources is used as speed reference 1.	3
	Min	The smaller of the reference sources is used as speed reference 1.	4
	Max	The greater of the reference sources is used as speed reference 1.	5
21.04	Speed ref1/2 sel	Configures the selection between speed references 1 and 2. (The sources for the references are defined by parameters 21.01 Speed ref1 sel and 21.02 Speed ref2 sel respectively.) 0 = Speed reference 1 1 = Speed reference 2	
	DI1	Digital input DI1 (as indicated by 02.01 DI status , bit 0).	1073742337
	DI2	Digital input DI2 (as indicated by 02.01 DI status , bit 1).	1073807873
	DI3	Digital input DI3 (as indicated by 02.01 DI status , bit 2).	1073873409
	DI4	Digital input DI4 (as indicated by 02.01 DI status , bit 3).	1073938945
	DI5	Digital input DI5 (as indicated by 02.01 DI status , bit 4).	1074004481
	DI6	Digital input DI6 (as indicated by 02.01 DI status , bit 5).	1074070017

154 Parameters

No.	Name/Value	Description	FbEq
	Const	Bit pointer setting (see Terms and abbreviations on page 93).	-
	Pointer		
21.05	Speed share	Defines the scaling factor for speed reference 1/2 (speed reference 1 or 2 is multiplied by the defined value). Speed reference 1 or 2 is selected by parameter 21.04 Speed ref1/2 sel.	
	-8.000 ... 8.000	Speed reference scaling factor.	1000 = 1
21.07	Speed ref jog1	Defines the speed reference for jogging function 1. For more information on jogging, see page 63.	
	-30000 ... 30000 rpm	Speed reference for jogging function 1.	1 = 1 rpm
21.08	Speed ref jog2	Defines the speed reference for jogging function 2. For more information on jogging, see page 63.	
	-30000 ... 30000 rpm	Speed reference for jogging function 2.	1 = 1 rpm
21.09	SpeedRef min abs	Defines the absolute minimum limit for the speed reference.	
<p><i>Limited speed reference</i></p> <p>The graph illustrates the 'Limited speed reference' function. The vertical axis represents the speed reference, and the horizontal axis represents the speed reference. The function is defined by several key parameters:</p> <ul style="list-style-type: none"> 20.01 Maximum speed: The upper limit of the speed reference, indicated by a dashed horizontal line. 21.09 SpeedRef min abs: The absolute minimum limit for the speed reference, indicated by a dashed horizontal line. -(21.09 SpeedRef min abs): The negative absolute minimum limit for the speed reference, indicated by a dashed horizontal line. 20.02 Minimum speed: The lower limit of the speed reference, indicated by a dashed horizontal line. <p>The function starts at the minimum speed (20.02), increases linearly to the absolute minimum limit (21.09), remains constant at that level, then increases linearly to the maximum speed (20.01), and remains constant at that level.</p>			
	0 ... 30000 rpm	Absolute minimum limit for speed reference.	1 = 1 rpm
21.10	Mot pot func	Selects whether the value of the motor potentiometer is retained upon drive power-off.	
	Reset	Drive power-off resets the value of the motor potentiometer.	0
	Store	The value of the motor potentiometer is retained over drive power-off.	1
21.11	Mot pot up	Selects the source of motor potentiometer up signal.	
	DI4	Digital input DI4 (as indicated by 02.01 DI status , bit 3).	1073938945
	DI5	Digital input DI5 (as indicated by 02.01 DI status , bit 4).	1074004481
	DI6	Digital input DI6 (as indicated by 02.01 DI status , bit 5).	1074070017
	Const	Bit pointer setting (see Terms and abbreviations on page 93).	-
	Pointer		

No.	Name/Value	Description	FbEq
21.12	Mot pot down	Selects the source of motor potentiometer down signal.	
	DI4	Digital input DI4 (as indicated by 02.01 DI status , bit 3).	1073938945
	DI5	Digital input DI5 (as indicated by 02.01 DI status , bit 4).	1074004481
	DI6	Digital input DI6 (as indicated by 02.01 DI status , bit 5).	1074070017
	Const	Bit pointer setting (see Terms and abbreviations on page 93).	-
	Pointer		
22 Speed ref ramp		Speed reference ramp settings.	
22.01	Acc/Dec sel	Selects the source that switches between the two sets of acceleration/deceleration times defined by parameters 22.02...22.05 . 0 = Acceleration time 1 and deceleration time 1 are in force 1 = Acceleration time 2 and deceleration time 2 are in force.	
	DI1	Digital input DI1 (as indicated by 02.01 DI status , bit 0).	1073742337
	DI2	Digital input DI2 (as indicated by 02.01 DI status , bit 1).	1073807873
	DI3	Digital input DI3 (as indicated by 02.01 DI status , bit 2).	1073873409
	DI4	Digital input DI4 (as indicated by 02.01 DI status , bit 3).	1073938945
	DI5	Digital input DI5 (as indicated by 02.01 DI status , bit 4).	1074004481
	DI6	Digital input DI6 (as indicated by 02.01 DI status , bit 5).	1074070017
	Const	Bit pointer setting (see Terms and abbreviations on page 93).	-
	Pointer		
22.02	Acc time1	Defines acceleration time 1 as the time required for the speed to change from zero to the speed value defined by parameter 19.01 Speed scaling . If the speed reference increases faster than the set acceleration rate, the motor speed will follow the acceleration rate. If the speed reference increases slower than the set acceleration rate, the motor speed will follow the reference signal. If the acceleration time is set too short, the drive will automatically prolong the acceleration in order not to exceed the drive torque limits.	
	0.000 ... 1800.000 s	Acceleration time 1.	1000 = 1 s

No.	Name/Value	Description	FbEq
22.03	Dec time1	<p>Defines deceleration time 1 as the time required for the speed to change from the speed value defined by parameter 19.01 Speed scaling to zero.</p> <p>If the speed reference decreases slower than the set deceleration rate, the motor speed will follow the reference signal.</p> <p>If the reference changes faster than the set deceleration rate, the motor speed will follow the deceleration rate.</p> <p>If the deceleration time is set too short, the drive will automatically prolong the deceleration in order not to exceed drive torque limits. If there is any doubt about the deceleration time being too short, ensure that the DC overvoltage control is on (parameter 47.01 Overvolt ctrl).</p> <p>Note: If a short deceleration time is needed for a high inertia application, the drive should be equipped with an electric braking option e.g. with a brake chopper (built-in) and a brake resistor.</p>	
	0.000 ... 1800.000 s	Deceleration time 1.	1000 = 1 s
22.04	Acc time2	Defines acceleration time 2. See parameter 22.02 Acc time1 .	
	0.000 ... 1800.000 s	Acceleration time 2.	1000 = 1 s
22.05	Dec time2	Defines deceleration time 2. See parameter 22.03 Dec time1 .	
	0.000 ... 1800.000 s	Deceleration time 2.	1000 = 1 s

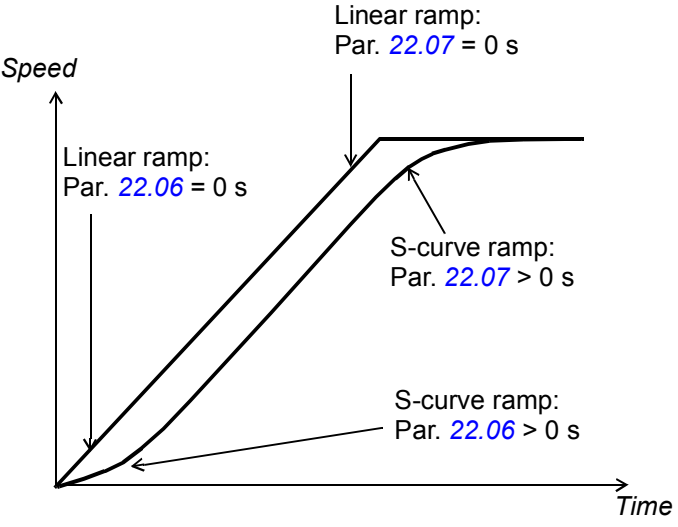
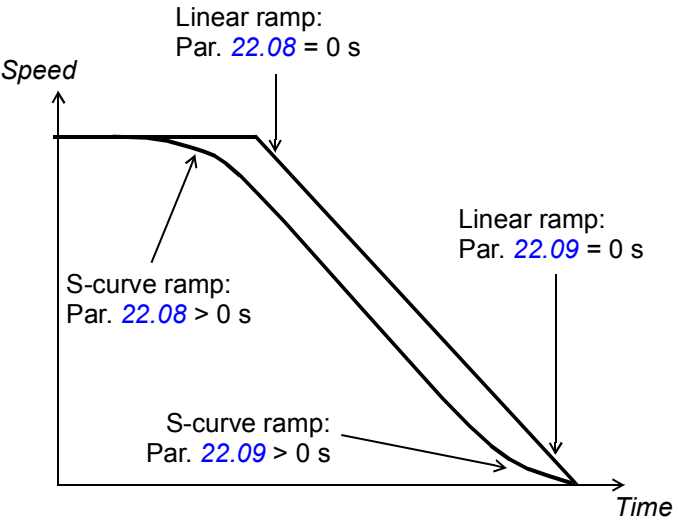
No.	Name/Value	Description	FbEq
22.06	Shape time acc1	<p>Defines the shape of the acceleration ramp at the beginning of the acceleration.</p> <p>0.000 s: Linear ramp. Suitable for steady acceleration or deceleration and for slow ramps.</p> <p>0.001... 1000.000 s: S-curve ramp. S-curve ramps are ideal for lifting applications. The S-curve consists of symmetrical curves at both ends of the ramp and a linear part in between.</p> <p>Acceleration:</p>  <p>Deceleration:</p> 	
	0.000 ... 1800.000 s	Ramp shape at start of acceleration.	1000 = 1 s
22.07	Shape time acc2	Defines the shape of the acceleration ramp at the end of the acceleration. See parameter 22.06 Shape time acc1 .	
	0.000 ... 1800.000 s	Ramp shape at end of acceleration.	1000 = 1 s
22.08	Shape time dec1	Defines the shape of the deceleration ramp at the beginning of the deceleration. See parameter 22.06 Shape time acc1 .	
	0.000 ... 1800.000 s	Ramp shape at start of deceleration.	1000 = 1 s

No.	Name/Value	Description	FbEq
22.09	Shape time dec2	Defines the shape of the deceleration ramp at the end of the deceleration. See parameter 22.06 Shape time acc1 .	
	0.000 ... 1800.000 s	Ramp shape at end of deceleration.	1000 = 1 s
22.10	Acc time jogging	Defines the acceleration time for the jogging function i.e. the time required for the speed to change from zero to the speed value defined by parameter 19.01 Speed scaling .	
	0.000 ... 1800.000 s	Acceleration time for jogging.	1000 = 1 s
22.11	Dec time jogging	Defines the deceleration time for the jogging function i.e. the time required for the speed to change from the speed value defined by parameter 19.01 Speed scaling to zero.	
	0.000 ... 1800.000 s	Deceleration time for jogging.	1000 = 1 s
22.12	Em stop time	Defines the time inside which the drive is stopped if an emergency stop OFF3 is activated (i.e. the time required for the speed to change from the speed value defined by parameter 19.01 Speed scaling to zero). Emergency stop activation source is selected by parameter 10.13 Em stop off3 . Emergency stop can also be activated through fieldbus (02.22 FBA main cw). Note: Emergency stop OFF1 uses the active ramp time.	
	0.000 ... 1800.000 s	Emergency stop OFF3 deceleration time.	1000 = 1 s

23 Speed ctrl		Speed controller settings. For an autotune function, see parameter 23.20 PI tune mode .	
23.01	Proport gain	Defines the proportional gain (K_p) of the speed controller. Too great a gain may cause speed oscillation. The figure below shows the speed controller output after an error step when the error remains constant.	
<p>Gain = $K_p = 1$ T_I = Integration time = 0 T_D = Derivation time = 0</p> <p>Controller output = $K_p \times e$</p> <p>e = Error value</p>			
	0.00 ... 200.00	Proportional gain for speed controller.	100 = 1

If gain is set to 1, a 10% change in error value (reference - actual value) causes the speed controller output to change by 10%.
Note: This parameter is automatically set by the speed controller autotune function. See parameter [23.20 PI tune mode](#).

No.	Name/Value	Description	FbEq
23.02	Integration time	<p>Defines the integration time of the speed controller. The integration time defines the rate at which the controller output changes when the error value is constant and the proportional gain of the speed controller is 1. The shorter the integration time, the faster the continuous error value is corrected. Too short an integration time makes the control unstable.</p> <p>If parameter value is set to zero, the I-part of the controller is disabled.</p> <p>Anti-windup stops the integrator if the controller output is limited. See 06.05 Limit word1.</p> <p>The figure below shows the speed controller output after an error step when the error remains constant.</p>	
<p>The graph plots Controller output (%) on the vertical axis against Time on the horizontal axis. A horizontal dashed line represents a constant error value e. The controller output starts at zero, jumps to $K_p \times e$ at time T_i, and then continues to rise linearly. A vertical dashed line marks the time T_i when the output reaches the level $K_p \times e$. Text on the right specifies: Gain = $K_p = 1$, $T_i =$ Integration time > 0, and $T_D =$ Derivation time $= 0$. A bracket on the horizontal axis indicates the time T_i from the start of the error step to the point where the output reaches $K_p \times e$.</p>			
<p>Note: This parameter is automatically set by the speed controller autotune function. See parameter 23.20 PI tune mode.</p>			
	0.00 ... 600.00 s	Integration time for speed controller.	100 = 1 s

No.	Name/Value	Description	FbEq
23.03	Derivation time	<p>Defines the derivation time of the speed controller. Derivative action boosts the controller output if the error value changes. The longer the derivation time, the more the speed controller output is boosted during the change. If the derivation time is set to zero, the controller works as a PI controller, otherwise as a PID controller. The derivation makes the control more responsive for disturbances.</p> <p>The speed error derivative must be filtered with a low pass filter to eliminate disturbances.</p> <p>The figure below shows the speed controller output after an error step when the error remains constant.</p> <p>Gain = $K_p = 1$ T_i = Integration time > 0 T_D = Derivation time > 0 T_s = Sample time period = 250 μs Δe = Error value change between two samples</p> <p>Note: Changing this parameter value is recommended only if a pulse encoder is used.</p>	
	0.000 ... 10.000 s	Derivation time for speed controller.	1000 = 1 s
23.04	Deriv filt time	Defines the derivation filter time constant. See parameter 23.03 Derivation time .	
	0.0 ... 1000.0 ms	Derivation filter time constant.	10 = 1 ms

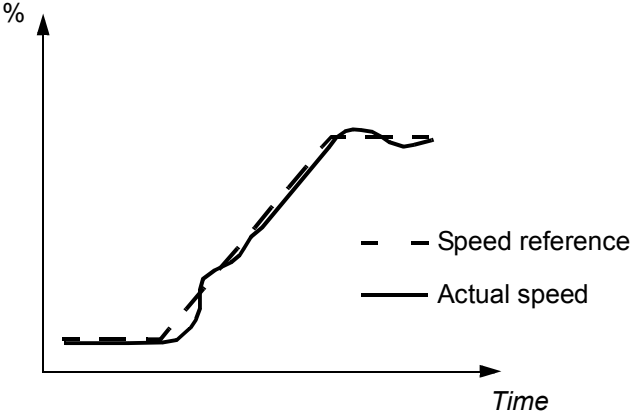
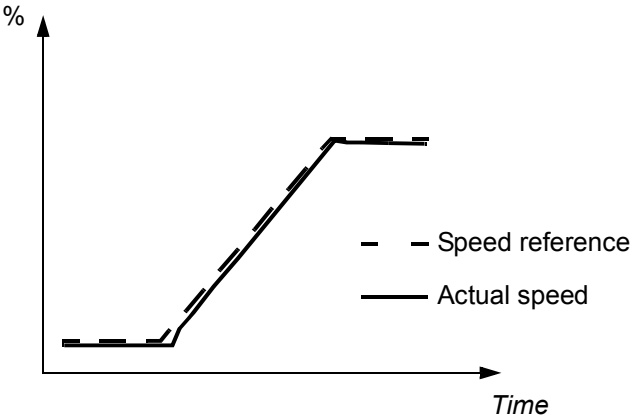
No.	Name/Value	Description	FbEq
23.05	Acc comp DerTime	<p>Defines the derivation time for acceleration/(deceleration) compensation. In order to compensate inertia during acceleration, a derivative of the reference is added to the output of the speed controller. The principle of a derivative action is described for parameter 23.03 Derivation time.</p> <p>Note: As a general rule, set this parameter to the value between 50 and 100% of the sum of the mechanical time constants of the motor and the driven machine.</p> <p>The figure below shows the speed responses when a high inertia load is accelerated along a ramp.</p> <p>No acceleration compensation:</p>  <p>Acceleration compensation:</p> 	
	0.00 ... 600.00 s	Acceleration compensation derivation time.	100 = 1 s
23.06	Acc comp Ftime	<p>Defines the derivation filter time constant for the acceleration/(deceleration) compensation. See parameters 23.03 Derivation time and 23.05 Acc comp DerTime.</p> <p>Note: This parameter is automatically set by the speed controller autotune function (when performed in User mode). See parameter 23.20 PI tune mode.</p>	
	0.0 ... 1000.0 ms	Derivation filter time constant for acceleration compensation.	10 = 1 ms

162 Parameters

No.	Name/Value	Description	FbEq
23.07	Speed err Ftime	Defines the time constant of the speed error low pass filter. If the used speed reference changes rapidly (like in a servo application), the possible interferences in the speed measurement can be filtered with the speed error filter. Reducing the ripple with filter may cause speed controller tuning problems. A long filter time constant and fast acceleration time contradict one another. A very long filter time results in unstable control.	
	0.0 ... 1000.0 ms	Speed error filtering time constant. 0 = filtering disabled.	10 = 1 ms
23.08	Speed additive	Defines a speed reference to be added after ramping. Note: For safety reasons, the additive is not applied when stop functions are active.	
	Zero	Zero speed additive.	0
	AI1 scaled	02.05 AI1 scaled (see page 95).	1073742341
	AI2 scaled	02.07 AI2 scaled (see page 95).	1073742343
	FBA ref1	02.26 FBA main ref1 (see page 100).	1073742362
	FBA ref2	02.27 FBA main ref2 (see page 100).	1073742363
	D2D ref1	02.32 D2D ref1 (see page 101).	1073742368
	D2D ref2	02.33 D2D ref2 (see page 101).	1073742369
	PID out	04.05 Process PID out (see page 102).	1073742853
	Pointer	Value pointer setting (see Terms and abbreviations on page 93).	-
23.09	Max torq sp ctrl	Defines the maximum speed controller output torque.	
	-1600.0 ... 1600.0%	Maximum speed controller output torque.	10 = 1%
23.10	Min torq sp ctrl	Defines the minimum speed controller output torque.	
	-1600.0 ... 1600.0%	Minimum speed controller output torque.	10 = 1%
23.11	SpeedErr winFunc	Enables or disables speed error window control. Speed error window control forms a speed supervision function for a torque-controlled drive. It supervises the speed error value (speed reference – actual speed). In the normal operating range, window control keeps the speed controller input at zero. The speed controller is evoked only if <ul style="list-style-type: none"> the speed error exceeds the upper boundary of the window (parameter 23.12 SpeedErr win hi), or the absolute value of the negative speed error exceeds the lower boundary of the window (23.13 SpeedErr win lo). When the speed error moves outside the window, the exceeding part of the error value is connected to the speed controller. The speed controller produces a reference term relative to the input and gain of the speed controller (parameter 23.01 Proport gain) which the torque selector adds to the torque reference. The result is used as the internal torque reference for the drive. Example: In a load loss condition, the internal torque reference of the drive is decreased to prevent an excessive rise of the motor speed. If window control were inactive, the motor speed would rise until a speed limit of the drive were reached.	
	Disabled	Speed error window control inactive.	0

No.	Name/Value	Description	FbEq
	Absolute	Speed error window control active. The boundaries defined by parameters 23.12 SpeedErr win hi and 23.13 SpeedErr win lo are absolute.	1
	Relative	Speed error window control active. The boundaries defined by parameters 23.12 SpeedErr win hi and 23.13 SpeedErr win lo are relative to speed reference.	2
23.12	SpeedErr win hi	Defines the upper boundary of the speed error window. Depending on setting of parameter 23.11 SpeedErr winFunc , this is either an absolute value or relative to speed reference.	
	0 ... 3000 rpm	Upper boundary of speed error window.	1 = 1 rpm
23.13	SpeedErr win lo	Defines the lower boundary of the speed error window. Depending on setting of parameter 23.11 SpeedErr winFunc , this is either an absolute value or relative to speed reference.	
	0 ... 3000 rpm	Lower boundary of speed error window.	1 = 1 rpm
23.14	Drooping rate	<p>Defines the droop rate (in percent of the motor nominal speed). The drooping slightly decreases the drive speed as the drive load increases. The actual speed decrease at a certain operating point depends on the droop rate setting and the drive load (= torque reference / speed controller output). At 100% speed controller output, drooping is at its nominal level, i.e. equal to the value of this parameter. The drooping effect decreases linearly to zero along with the decreasing load.</p> <p>Droop rate can be used e.g. to adjust the load sharing in a Master/Follower application run by several drives. In a Master/Follower application the motor shafts are coupled to each other.</p> <p>The correct droop rate for a process must be found out case by case in practice.</p>	
<p>Speed decrease = Speed controller output × Drooping × Max. speed</p> <p>Example: Speed controller output is 50%, droop rate is 1%, maximum speed of the drive is 1500 rpm.</p> <p>Speed decrease = 0.50 × 0.01 × 1500 rpm = 7.5 rpm.</p>			
	0.00 ... 100.00%	Droop rate.	100 = 1%

No.	Name/Value	Description	FbEq
23.15	PI adapt max sp	<p>Maximum actual speed for speed controller adaptation. Speed controller gain and integration time can be adapted according to actual speed. This is done by multiplying the gain (23.01 Proport gain) and integration time (23.02 Integration time) by coefficients at certain speeds. The coefficients are defined individually for both gain and integration time.</p> <p>When the actual speed is below or equal to 23.16 PI adapt min sp, 23.01 Proport gain and 23.02 Integration time are multiplied by 23.17 Pcoef at min sp and 23.18 lcoef at min sp respectively.</p> <p>When the actual speed is equal to or exceeds 23.15 PI adapt max sp, no adaptation takes place; in other words, 23.01 Proport gain and 23.02 Integration time are used as such.</p> <p>Between 23.16 PI adapt min sp and 23.15 PI adapt max sp, the coefficients are calculated linearly on the basis of the breakpoints.</p> <div data-bbox="241 797 1332 1422" style="text-align: center;"> <p>Coefficient for K_p or T_i</p> <p>K_p = Proportional gain T_i = Integration time</p> </div>	
	0 ... 30000 rpm	Maximum actual speed for speed controller adaptation.	1 = 1 rpm
23.16	PI adapt min sp	Minimum actual speed for speed controller adaptation. See parameter 23.15 PI adapt max sp.	
	0 ... 30000 rpm	Minimum actual speed for speed controller adaptation.	1 = 1 rpm
23.17	Pcoef at min sp	Proportional gain coefficient at minimum actual speed. See parameter 23.15 PI adapt max sp.	
	0.000 ... 10.000	Proportional gain coefficient at minimum actual speed.	1000 = 1
23.18	lcoef at min sp	Integration time coefficient at minimum actual speed. See parameter 23.15 PI adapt max sp.	
	0.000 ... 10.000	Integration time coefficient at minimum actual speed.	1000 = 1

No.	Name/Value	Description	FbEq
23.20	PI tune mode	<p>Activates the speed controller autotune function. The autotune will automatically set parameters 23.01 Proport gain and 23.02 Integration time, as well as 01.31 Mech time const. If the <i>User</i> autotune mode is chosen, also 23.07 Speed err Ftime is automatically set.</p> <p>The status of the autotune routine is shown by parameter 06.03 Speed ctrl stat.</p> <p> WARNING! The motor will reach the torque and current limits during the autotune routine. ENSURE THAT IT IS SAFE TO RUN THE MOTOR BEFORE PERFORMING THE AUTOTUNE ROUTINE!</p> <p>Notes:</p> <ul style="list-style-type: none"> • Before using the autotune function, the following parameters should be set: <ul style="list-style-type: none"> • All parameters adjusted during the start-up as described in the <i>ACS850 (Standard Control Program) Quick Start-up Guide</i> • 19.01 Speed scaling • 19.03 MotorSpeed filt • 19.06 Zero speed limit • Speed reference ramp settings in group 22 Speed ref ramp • 23.07 Speed err Ftime. • The drive must be in local control mode and stopped before an autotune is requested. • After requesting an autotune with this parameter, start the drive within 20 seconds. • Wait until the autotune routine is completed (this parameter has reverted to the value <i>Done</i>). The routine can be aborted by stopping the drive. <p>See also section Speed controller tuning (page 74).</p>	
	Done	No tuning has been requested (normal operation). The parameter also reverts to this value after an autotune is completed.	0
	Smooth	Request speed controller autotune with preset settings for smooth operation.	1
	Middle	Request speed controller autotune with preset settings for medium-tight operation.	2
	Tight	Request speed controller autotune with preset settings for tight operation.	3
	User	Request speed controller autotune with the settings defined by parameters 23.21 Tune bandwidth and 23.22 Tune damping .	4
23.21	Tune bandwidth	Speed controller bandwidth for autotune procedure, <i>User</i> mode (see parameter 23.20 PI tune mode). A larger bandwidth results in more restricted speed controller settings.	
	00.00 ... 2000.00 Hz	Tune bandwidth for <i>User</i> autotune mode.	100 = 1 Hz
23.22	Tune damping	Speed controller damping for autotune procedure, <i>User</i> mode (see parameter 23.20 PI tune mode). Higher damping results in safer and smoother operation.	
	0.0 ... 200.0	Speed controller damping for <i>User</i> autotune mode.	10 = 1

No.	Name/Value	Description	FbEq
24 Torque ref		Torque reference selection, limitation and modification settings.	
24.01	Torq ref1 sel	Selects the source for torque reference 1.	
	Zero	No torque reference selected.	0
	AI1 scaled	02.05 AI1 scaled (see page 95).	1073742341
	AI2 scaled	02.07 AI2 scaled (see page 95).	1073742343
	FBA ref1	02.26 FBA main ref1 (see page 100).	1073742362
	FBA ref2	02.27 FBA main ref2 (see page 100).	1073742363
	D2D ref1	02.32 D2D ref1 (see page 101).	1073742368
	D2D ref2	02.33 D2D ref2 (see page 101).	1073742369
	PID out	04.05 Process PID out (see page 102).	1073742853
	Pointer	Value pointer setting (see Terms and abbreviations on page 93).	-
24.02	Torq ref add sel	Selects the source for the torque reference addition. Because the reference is added after the torque reference selection, this parameter can be used in speed and torque control modes. Note: For safety reasons, this reference addition is not applied when stop functions are active.	
	Zero	No torque reference addition selected.	0
	AI1 scaled	02.05 AI1 scaled (see page 95).	1073742341
	AI2 scaled	02.07 AI2 scaled (see page 95).	1073742343
	FBA ref1	02.26 FBA main ref1 (see page 100).	1073742362
	FBA ref2	02.27 FBA main ref2 (see page 100).	1073742363
	D2D ref1	02.32 D2D ref1 (see page 101).	1073742368
	D2D ref2	02.33 D2D ref2 (see page 101).	1073742369
	PID out	04.05 Process PID out (see page 102).	1073742853
	Pointer	Value pointer setting (see Terms and abbreviations on page 93).	-
24.03	Maximum torq ref	Defines the maximum torque reference.	
	0.0 ... 1000.0%	Maximum torque reference.	10 = 1%
24.04	Minimum torq ref	Defines the minimum torque reference.	
	-1000.0 ... 0.0%	Minimum torque reference.	10 = 1%
24.05	Load share	Scales the torque reference to a required level (torque reference is multiplied by the selected value).	
	-8.000 ... 8.000	Torque reference scaling.	1000 = 1
24.06	Torq ramp up	Defines the torque reference ramp-up time, i.e. the time for the reference to increase from zero to the nominal motor torque.	
	0.000 ... 60.000 s	Torque reference ramp-up time.	1000 = 1 s
24.07	Torq ramp down	Defines the torque reference ramp-down time, i.e. the time for the reference to decrease from the nominal motor torque to zero.	
	0.000 ... 60.000 s	Torque reference ramp-down time.	1000 = 1 s

No.	Name/Value	Description	FbEq								
25 Critical speed		Sets up critical speeds, or ranges of speeds, that are avoided due to, for example, mechanical resonance problems.									
25.01	Crit speed sel	<p>Enables/disables the critical speeds function.</p> <p>Example: A fan has vibrations in the range of 540 to 690 rpm and 1380 to 1560 rpm. To make the drive to jump over the vibration speed ranges:</p> <ul style="list-style-type: none"> • activate the critical speeds function, • set the critical speed ranges as in the figure below. <div style="text-align: center;"> </div> <table border="1" style="margin-left: auto; margin-right: auto;"> <tbody> <tr> <td>1</td> <td>Par. 25.02 = 540 rpm</td> </tr> <tr> <td>2</td> <td>Par. 25.03 = 690 rpm</td> </tr> <tr> <td>3</td> <td>Par. 25.04 = 1380 rpm</td> </tr> <tr> <td>4</td> <td>Par. 25.05 = 1590 rpm</td> </tr> </tbody> </table>	1	Par. 25.02 = 540 rpm	2	Par. 25.03 = 690 rpm	3	Par. 25.04 = 1380 rpm	4	Par. 25.05 = 1590 rpm	
1	Par. 25.02 = 540 rpm										
2	Par. 25.03 = 690 rpm										
3	Par. 25.04 = 1380 rpm										
4	Par. 25.05 = 1590 rpm										
	Disable	Critical speeds are disabled.	0								
	Enable	Critical speeds are enabled.	1								
25.02	Crit speed1 lo	<p>Defines the low limit for critical speed range 1.</p> <p>Note: This value must be less than or equal to the value of 25.03 Crit speed1 hi.</p>									
	-30000 ... 30000 rpm	Low limit for critical speed 1.	1 = 1 rpm								
25.03	Crit speed1 hi	<p>Defines the high limit for critical speed range 1.</p> <p>Note: This value must be greater than or equal to the value of 25.02 Crit speed1 lo.</p>									
	-30000 ... 30000 rpm	High limit for critical speed 1.	1 = 1 rpm								
25.04	Crit speed2 lo	<p>Defines the low limit for critical speed range 2.</p> <p>Note: This value must be less than or equal to the value of 25.05 Crit speed2 hi.</p>									
	-30000 ... 30000 rpm	Low limit for critical speed 2.	1 = 1 rpm								
25.05	Crit speed2 hi	<p>Defines the high limit for critical speed range 2.</p> <p>Note: This value must be greater than or equal to the value of 25.04 Crit speed2 lo.</p>									

No.	Name/Value	Description	FbEq
	-30000 ... 30000 rpm	High limit for critical speed 2.	1 = 1 rpm
25.06	Crit speed3 lo	Defines the low limit for critical speed range 3. Note: This value must be less than or equal to the value of 25.07 Crit speed3 hi .	
	-30000 ... 30000 rpm	Low limit for critical speed 3.	1 = 1 rpm
25.07	Crit speed3 hi	Defines the high limit for critical speed range 3. Note: This value must be greater than or equal to the value of 25.06 Crit speed3 lo .	
	-30000 ... 30000 rpm	High limit for critical speed 3.	1 = 1 rpm

26 Constant speeds		Constant speed selection and values. An active constant speed overrides the drive speed reference. See section Constant speeds on page 59.																																					
26.01	Const speed func	Determines how constant speeds are selected, and whether the rotation direction signal is considered or not when applying a constant speed.																																					
		<table border="1"> <thead> <tr> <th>Bit</th> <th>Name</th> <th>Information</th> </tr> </thead> <tbody> <tr> <td>0</td> <td>Const speed mode</td> <td>1 = Packed: 7 constant speeds are selectable using the three sources defined by parameters 26.02, 26.03 and 26.04. 0 = Separate: Constant speeds 1, 2 and 3 are separately activated by the sources defined by parameters 26.02, 26.03 and 26.04 respectively. In case of conflict, the constant speed with the smaller number takes priority.</td> </tr> <tr> <td>1</td> <td>Dir ena</td> <td>1 = Start dir: To determine running direction for a constant speed, the sign of the constant speed setting (parameters 26.06...26.12) is multiplied by the direction signal (forward: +1, reverse: -1). For example, if the direction signal is reverse and the active constant speed is negative, the drive will run in the forward direction. 0 = Accord Par: The running direction for the constant speed is determined by the sign of the constant speed setting (parameters 26.06...26.12).</td> </tr> </tbody> </table>	Bit	Name	Information	0	Const speed mode	1 = Packed: 7 constant speeds are selectable using the three sources defined by parameters 26.02 , 26.03 and 26.04 . 0 = Separate: Constant speeds 1, 2 and 3 are separately activated by the sources defined by parameters 26.02 , 26.03 and 26.04 respectively. In case of conflict, the constant speed with the smaller number takes priority.	1	Dir ena	1 = Start dir: To determine running direction for a constant speed, the sign of the constant speed setting (parameters 26.06...26.12) is multiplied by the direction signal (forward: +1, reverse: -1). For example, if the direction signal is reverse and the active constant speed is negative, the drive will run in the forward direction. 0 = Accord Par: The running direction for the constant speed is determined by the sign of the constant speed setting (parameters 26.06...26.12).																												
Bit	Name	Information																																					
0	Const speed mode	1 = Packed: 7 constant speeds are selectable using the three sources defined by parameters 26.02 , 26.03 and 26.04 . 0 = Separate: Constant speeds 1, 2 and 3 are separately activated by the sources defined by parameters 26.02 , 26.03 and 26.04 respectively. In case of conflict, the constant speed with the smaller number takes priority.																																					
1	Dir ena	1 = Start dir: To determine running direction for a constant speed, the sign of the constant speed setting (parameters 26.06...26.12) is multiplied by the direction signal (forward: +1, reverse: -1). For example, if the direction signal is reverse and the active constant speed is negative, the drive will run in the forward direction. 0 = Accord Par: The running direction for the constant speed is determined by the sign of the constant speed setting (parameters 26.06...26.12).																																					
26.02	Const speed sel1	When bit 0 of parameter 26.01 Const speed func is 0 (Separate), selects a source that activates constant speed 1. When bit 0 of parameter 26.01 Const speed func is 1 (Packed), this parameter and parameters 26.03 Const speed sel2 and 26.04 Const speed sel3 select three sources whose states activate constant speeds as follows:																																					
		<table border="1"> <thead> <tr> <th>Source defined by par. 26.02</th> <th>Source defined by par. 26.03</th> <th>Source defined by par. 26.04</th> <th>Constant speed active</th> </tr> </thead> <tbody> <tr> <td>0</td> <td>0</td> <td>0</td> <td>None</td> </tr> <tr> <td>1</td> <td>0</td> <td>0</td> <td>Constant speed 1</td> </tr> <tr> <td>0</td> <td>1</td> <td>0</td> <td>Constant speed 2</td> </tr> <tr> <td>1</td> <td>1</td> <td>0</td> <td>Constant speed 3</td> </tr> <tr> <td>0</td> <td>0</td> <td>1</td> <td>Constant speed 4</td> </tr> <tr> <td>1</td> <td>0</td> <td>1</td> <td>Constant speed 5</td> </tr> <tr> <td>0</td> <td>1</td> <td>1</td> <td>Constant speed 6</td> </tr> <tr> <td>1</td> <td>1</td> <td>1</td> <td>Constant speed 7</td> </tr> </tbody> </table>	Source defined by par. 26.02	Source defined by par. 26.03	Source defined by par. 26.04	Constant speed active	0	0	0	None	1	0	0	Constant speed 1	0	1	0	Constant speed 2	1	1	0	Constant speed 3	0	0	1	Constant speed 4	1	0	1	Constant speed 5	0	1	1	Constant speed 6	1	1	1	Constant speed 7	
Source defined by par. 26.02	Source defined by par. 26.03	Source defined by par. 26.04	Constant speed active																																				
0	0	0	None																																				
1	0	0	Constant speed 1																																				
0	1	0	Constant speed 2																																				
1	1	0	Constant speed 3																																				
0	0	1	Constant speed 4																																				
1	0	1	Constant speed 5																																				
0	1	1	Constant speed 6																																				
1	1	1	Constant speed 7																																				
DI1		Digital input DI1 (as indicated by 02.01 DI status , bit 0).	1073742337																																				

No.	Name/Value	Description	FbEq
	D12	Digital input DI2 (as indicated by 02.01 DI status , bit 1).	1073807873
	D13	Digital input DI3 (as indicated by 02.01 DI status , bit 2).	1073873409
	D14	Digital input DI4 (as indicated by 02.01 DI status , bit 3).	1073938945
	D15	Digital input DI5 (as indicated by 02.01 DI status , bit 4).	1074004481
	D16	Digital input DI6 (as indicated by 02.01 DI status , bit 5).	1074070017
	Const	Bit pointer setting (see Terms and abbreviations on page 93).	-
	Pointer		
26.03	Const speed sel2	When bit 0 of parameter 26.01 Const speed func is 0 (Separate), selects a source that activates constant speed 2. When bit 0 of parameter 26.01 Const speed func is 1 (Packed), this parameter and parameters 26.02 Const speed sel1 and 26.04 Const speed sel3 select three sources that are used to activate constant speeds. See table at parameter 26.02 Const speed sel1 .	
	D11	Digital input DI1 (as indicated by 02.01 DI status , bit 0).	1073742337
	D12	Digital input DI2 (as indicated by 02.01 DI status , bit 1).	1073807873
	D13	Digital input DI3 (as indicated by 02.01 DI status , bit 2).	1073873409
	D14	Digital input DI4 (as indicated by 02.01 DI status , bit 3).	1073938945
	D15	Digital input DI5 (as indicated by 02.01 DI status , bit 4).	1074004481
	D16	Digital input DI6 (as indicated by 02.01 DI status , bit 5).	1074070017
	Const	Bit pointer setting (see Terms and abbreviations on page 93).	-
	Pointer		
26.04	Const speed sel3	When bit 0 of parameter 26.01 Const speed func is 0 (Separate), selects a source that activates constant speed 3. When bit 0 of parameter 26.01 Const speed func is 1 (Packed), this parameter and parameters 26.02 Const speed sel1 and 26.03 Const speed sel2 select three sources that are used to activate constant speeds. See table at parameter 26.02 Const speed sel1 .	
	D11	Digital input DI1 (as indicated by 02.01 DI status , bit 0).	1073742337
	D12	Digital input DI2 (as indicated by 02.01 DI status , bit 1).	1073807873
	D13	Digital input DI3 (as indicated by 02.01 DI status , bit 2).	1073873409
	D14	Digital input DI4 (as indicated by 02.01 DI status , bit 3).	1073938945
	D15	Digital input DI5 (as indicated by 02.01 DI status , bit 4).	1074004481
	D16	Digital input DI6 (as indicated by 02.01 DI status , bit 5).	1074070017
	Const	Bit pointer setting (see Terms and abbreviations on page 93).	-
	Pointer		
26.06	Const speed1	Defines constant speed 1.	
	-30000 ... 30000 rpm	Constant speed 1.	1 = 1 rpm
26.07	Const speed2	Defines constant speed 2.	
	-30000 ... 30000 rpm	Constant speed 2.	1 = 1 rpm
26.08	Const speed3	Defines constant speed 3.	
	-30000 ... 30000 rpm	Constant speed 3.	1 = 1 rpm

170 Parameters

No.	Name/Value	Description	FbEq
26.09	Const speed4	Defines constant speed 4.	
	-30000 ... 30000 rpm	Constant speed 4.	1 = 1 rpm
26.10	Const speed5	Defines constant speed 5.	
	-30000 ... 30000 rpm	Constant speed 5.	1 = 1 rpm
26.11	Const speed6	Defines constant speed 6.	
	-30000 ... 30000 rpm	Constant speed 6.	1 = 1 rpm
26.12	Const speed7	Defines constant speed 7.	
	-30000 ... 30000 rpm	Constant speed 7.	1 = 1 rpm
27 Process PID		Configuration of process PID control. See also section Process PID control on page 70.	
27.01	PID setpoint sel	Selects the source of setpoint (reference) for the PID controller.	
	Zero	Zero reference.	0
	AI1 scaled	02.05 AI1 scaled (see page 95).	1073742341
	AI2 scaled	02.07 AI2 scaled (see page 95).	1073742343
	FBA ref1	02.26 FBA main ref1 (see page 100).	1073742362
	FBA ref2	02.27 FBA main ref2 (see page 100).	1073742363
	D2D ref1	02.32 D2D ref1 (see page 101).	1073742368
	D2D ref2	02.33 D2D ref2 (see page 101).	1073742369
	Pointer	Value pointer setting (see Terms and abbreviations on page 93).	-
27.02	PID fbk func	Defines how the final process feedback is calculated from the two sources selected by parameters 27.03 PID fbk1 src and 27.04 PID fbk2 src .	
	Act1	Process feedback 1 used.	0
	Add	Sum of feedback 1 and feedback 2.	1
	Sub	Feedback 2 subtracted from feedback 1.	2
	Mul	Feedback 1 multiplied by feedback 2.	3
	div	Feedback 1 divided by feedback 2.	4
	Max	Greater of the two feedback sources used.	5
	Min	Smaller of the two feedbacks sources used.	6
	Sqrt sub	Square root of (feedback 1 – feedback 2).	7
	Sqrt add	Square root of feedback 1 + square root of feedback 2.	8
27.03	PID fbk1 src	Selects the source of process feedback 1.	
	Zero	Zero feedback.	0
	AI1 scaled	02.05 AI1 scaled (see page 95).	1073742341
	AI2 scaled	02.07 AI2 scaled (see page 95).	1073742343
	FBA ref1	02.26 FBA main ref1 (see page 100).	1073742362
	FBA ref2	02.27 FBA main ref2 (see page 100).	1073742363
	D2D ref1	02.32 D2D ref1 (see page 101).	1073742368

No.	Name/Value	Description	FbEq
	D2D ref2	02.33 D2D ref2 (see page 101).	1073742369
	Pointer	Value pointer setting (see Terms and abbreviations on page 93).	-
27.04	PID fbk2 src	Selects the source of process feedback 2.	
	Zero	Zero feedback.	0
	AI1 scaled	02.05 AI1 scaled (see page 95).	1073742341
	AI2 scaled	02.07 AI2 scaled (see page 95).	1073742343
	FBA ref1	02.26 FBA main ref1 (see page 100).	1073742362
	FBA ref2	02.27 FBA main ref2 (see page 100).	1073742363
	D2D ref1	02.32 D2D ref1 (see page 101).	1073742368
	D2D ref2	02.33 D2D ref2 (see page 101).	1073742369
	Pointer	Value pointer setting (see Terms and abbreviations on page 93).	-
27.05	PID fbk1 max	Maximum value for process feedback 1.	
	-32768.00 ... 32768.00	Maximum value for process feedback 1.	100 = 1
27.06	PID fbk1 min	Minimum value for process feedback 1.	
	-32768.00 ... 32768.00	Minimum value for process feedback 1.	100 = 1
27.07	PID fbk2 max	Maximum value for process feedback 2.	
	-32768.00 ... 32768.00	Maximum value for process feedback 2.	100 = 1
27.08	PID fbk2 min	Minimum value for process feedback 2.	
	-32768.00 ... 32768.00	Minimum value for process feedback 2.	100 = 1
27.09	PID fbk gain	Multiplier for scaling the final feedback value for process PID controller.	
	-32.768 ... 32.767	PID feedback gain.	1000 = 1

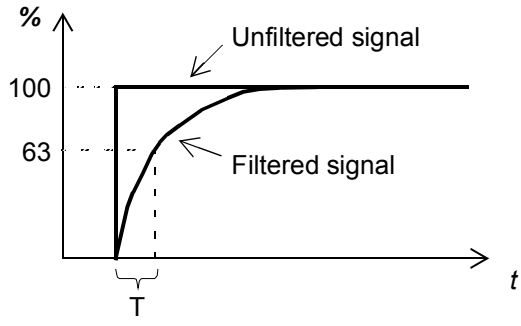
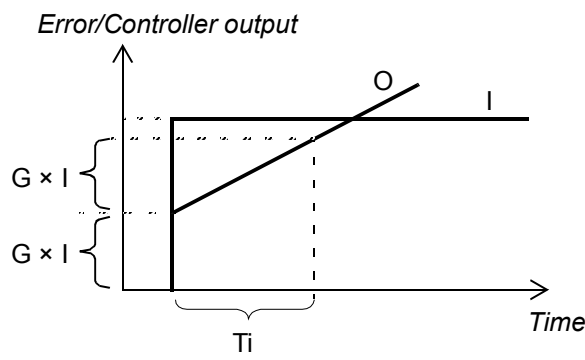

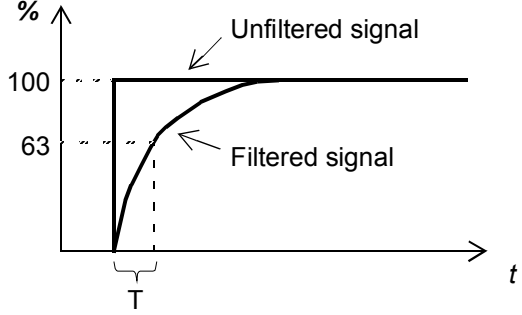
No.	Name/Value	Description	FbEq
27.10	PID fbk time	Defines the time constant for the filter through which the process feedback is connected to the PID controller.	
	0.000 ... 30.000 s	<p>Filter time constant.</p>  $O = I \times (1 - e^{-t/T})$ <p> I = filter input (step) O = filter output t = time T = filter time constant </p>	1000 = 1 s
27.12	PID gain	Defines the gain for the process PID controller. See parameter 27.13 PID integ time .	
	0.00 ... 100.00	Gain for PID controller.	100 = 1
27.13	PID integ time	<p>Defines the integration time for the process PID controller.</p>  <p> I = controller input (error) O = controller output G = gain Ti = integration time </p> <p>Note: Setting this value to 0 disables the “I” part, turning the PID controller into a PD controller.</p>	
	0.00 ... 320.00 s	Integration time.	100 = 1 s
27.14	PID deriv time	<p>Defines the derivation time of the process PID controller. The derivative component at the controller output is calculated on basis of two consecutive error values (E_{K-1} and E_K) according to the following formula:</p> <p>PID DERIV TIME $\times (E_K - E_{K-1})/T_S$, in which</p> <p>$T_S = 12$ ms sample time</p> <p>E = Error = Process reference - process feedback.</p>	
	0.00 ... 10.00 s	Derivation time.	100 = 1 s

No.	Name/Value	Description	FbEq
27.15	PID deriv filter	<p>Defines the time constant of the 1-pole filter used to smooth the derivative component of the process PID controller.</p>  <p>$O = I \times (1 - e^{-t/T})$</p> <p>I = filter input (step) O = filter output t = time T = filter time constant</p>	
	0.00 ... 10.00 s	Filter time constant.	100 = 1 s
27.16	PID error inv	PID error inversion. When the source selected by this parameter is on, the error (process setpoint – process feedback) at the PID controller input is inverted.	
	Const	Bit pointer setting (see Terms and abbreviations on page 93).	-
	Pointer		
27.17	PID mode	Activates the PID controller output trimming function. Using the trim it is possible to apply a correction factor to the drive reference.	
	Direct	Trimming not used.	0
	Prop speed	PID controller output is trimmed in proportion to speed.	1
	Prop torque	PID controller output is trimmed in proportion to torque.	2
27.18	PID maximum	Defines the maximum limit for the PID controller output. Using the minimum and maximum limits, it is possible to restrict the operation range.	
	-32768.0 ... 32768.0	Maximum limit for PID controller output.	10 = 1
27.19	PID minimum	Defines the minimum limit for the PID controller output. See parameter 27.18 PID maximum .	
	-32768.0 ... 32768.0	Minimum limit for PID controller output.	10 = 1
27.22	Sleep mode	Activates the sleep function.	
	No	Sleep function inactive.	0
	Internal	The sleep function is activated and deactivated automatically as defined by parameters 27.23 Sleep level and 27.24 Sleep delay . The sleep and wake-up delays (27.24 Sleep delay and 27.26 Wake up delay) are effective.	1
	External	The sleep function is activated by the source selected by parameter 27.27 Sleep ena . The sleep and wake-up delays (27.24 Sleep delay and 27.26 Wake up delay) are effective.	2

174 Parameters

No.	Name/Value	Description	FbEq
27.23	Sleep level	Defines the start limit for the sleep function. If the motor speed is below this value longer than the sleep delay (27.24 Sleep delay), the drive shifts to sleep mode.	
	-32768.0 ... 32768.0	Sleep start level.	10 = 1
27.24	Sleep delay	Defines the delay for the sleep start function. See parameter 27.23 Sleep level . When the motor speed falls below the sleep level, the counter starts. When the motor speed exceeds the sleep level, the counter resets.	
	0.0 ... 360.0 s	Sleep start delay.	10 = 1 s
27.25	Wake up level	Defines the wake-up limit for the sleep function. The drive wakes up if the process actual value is below a set level (27.23 Sleep level) longer than the wake-up delay (27.24 Sleep delay).	
	0.0 ... 32768.0	Wake-up level.	10 = 1
27.26	Wake up delay	Defines the wake-up delay for the sleep function. See parameter 27.25 Wake up level . When the process actual value falls below the wake-up level, the wake-up counter starts. When the process actual value exceeds the wake-up level, the counter resets.	
	0.0 ... 360.0 s	Wake-up delay.	10 = 1 s
27.27	Sleep ena	Defines a source that can be used to activate sleep mode when parameter 27.22 Sleep mode is set to <i>External</i> .	
	DI1	Digital input DI1 (as indicated by 02.01 DI status , bit 0).	1073742337
	DI2	Digital input DI2 (as indicated by 02.01 DI status , bit 1).	1073807873
	DI3	Digital input DI3 (as indicated by 02.01 DI status , bit 2).	1073873409
	DI4	Digital input DI4 (as indicated by 02.01 DI status , bit 3).	1073938945
	DI5	Digital input DI5 (as indicated by 02.01 DI status , bit 4).	1074004481
	DI6	Digital input DI6 (as indicated by 02.01 DI status , bit 5).	1074070017
	Const	Bit pointer setting (see Terms and abbreviations on page 93).	-
	Pointer		

30 Fault functions		Selects the behavior of the drive upon various fault situations.	
30.01	External fault	Selects an source for an external fault signal. 0 = External fault trip 1 = No external fault	
	DI1	Digital input DI1 (as indicated by 02.01 DI status , bit 0).	1073742337
	DI2	Digital input DI2 (as indicated by 02.01 DI status , bit 1).	1073807873
	DI3	Digital input DI3 (as indicated by 02.01 DI status , bit 2).	1073873409
	DI4	Digital input DI4 (as indicated by 02.01 DI status , bit 3).	1073938945
	DI5	Digital input DI5 (as indicated by 02.01 DI status , bit 4).	1074004481
	DI6	Digital input DI6 (as indicated by 02.01 DI status , bit 5).	1074070017
	DIO4	Digital input/output DIO4 (as indicated by 02.03 DIO status , bit 3).	1073938947
	DIO5	Digital input/output DIO5 (as indicated by 02.03 DIO status , bit 4).	1074004483
	DIO6	Digital input/output DIO6 (as indicated by 02.03 DIO status , bit 5).	1074070019

No.	Name/Value	Description	FbEq
	Const	Bit pointer setting (see Terms and abbreviations on page 93).	-
	Pointer		
30.02	Speed ref safe	Defines the safe speed reference that is used with the Spd ref Safe setting of supervision parameters 13.32 AI superv func , 30.03 Local ctrl loss or 50.02 Comm loss func upon an alarm. This speed is used when the parameter is set to Spd ref Safe .	
	-30000 ... 30000 rpm	Safe speed reference.	1 = 1 rpm
30.03	Local ctrl loss	Selects how the drive reacts to a control panel or PC tool communication break.	
	No	No action taken.	0
	Fault	Drive trips on fault LOCAL CTRL LOSS.	1
	Spd ref Safe	The drive generates alarm LOCAL CTRL LOSS and sets the speed to the speed defined by parameter 30.02 Speed ref safe .  WARNING! Make sure that it is safe to continue operation in case of a communication break.	2
	Last speed	The drive generates alarm LOCAL CTRL LOSS and freezes the speed to the level the drive was operating at. The speed is determined by the average speed over the previous 10 seconds.  WARNING! Make sure that it is safe to continue operation in case of a communication break.	3
30.04	Mot phase loss	Selects how the drive reacts when a motor phase loss is detected.	
	No	No action taken.	0
	Fault	The drive trips on fault MOTOR PHASE.	1
30.05	Earth fault	Selects how the drive reacts when an earth fault or current unbalance is detected in the motor or the motor cable.	
	No	No action taken.	0
	Warning	The drive generates alarm EARTH FAULT.	1
	Fault	The drive trips on fault EARTH FAULT.	2
30.06	Suppl phs loss	Selects how the drive reacts when a supply phase loss is detected.	
	No	No action taken.	0
	Fault	The drive trips on fault SUPPLY PHASE.	1

No.	Name/Value	Description	FbEq								
30.07	Sto diagnostic	<p>Selects how the drive reacts when the drive detects that the Safe Torque Off function is active while the drive is stopped. The Safe Torque Off function disables the control voltage of the power semiconductors of the drive output stage, thus preventing the inverter from generating the voltage required to rotate the motor. For the wiring of the Safe Torque Off circuit, see the appropriate hardware manual.</p> <p>Notes:</p> <ul style="list-style-type: none"> This parameter is for supervision only. The Safe Torque Off function can activate even when this parameter is set to <i>No</i>. Fault STO 1 LOST / STO 2 LOST is activated if safety circuit signal 1/2 is lost when the drive is in stopped state and this parameter is set to <i>Alarm</i> or <i>No</i>. 									
	Fault	The drive trips on fault SAFE TORQUE OFF.	1								
	Alarm	The drive generates alarm SAFE TORQUE OFF.	2								
	No	No action taken.	3								
30.08	Cross connection	Selects how the drive reacts to incorrect input power and motor cable connection (i.e. input power cable is connected to drive motor connection).									
	No	No action taken.	0								
	Fault	The drive trips on fault CABLE CROSS CON.	1								
30.09	Stall function	<p>Selects how the drive reacts to a motor stall condition. The protection wakes up if</p> <ul style="list-style-type: none"> the drive is at stall current limit (defined by parameter 30.10 Stall curr lim) or 06.05 Limit word1 differs from 0 the output frequency is below the level set by parameter 30.11 Stall freq hi, and the conditions above have been valid longer than the time set by parameter 30.12 Stall time. <p>See section Stall protection (parameters 30.09...30.12) on page 73.</p>									
<table border="1"> <thead> <tr> <th>Bit</th> <th>Function</th> </tr> </thead> <tbody> <tr> <td>0</td> <td>Ena sup (Enable supervision) 0 = Disabled: Supervision disabled. 1 = Enabled: Supervision enabled.</td> </tr> <tr> <td>1</td> <td>Ena warn (Enable warning) 0 = Disabled 1 = Enabled: Drive generates an alarm upon a stall condition.</td> </tr> <tr> <td>2</td> <td>Ena fault (Enable fault) 0 = Disabled 1 = Enabled: Drive trips on a fault upon a stall condition.</td> </tr> </tbody> </table>				Bit	Function	0	Ena sup (Enable supervision) 0 = Disabled: Supervision disabled. 1 = Enabled: Supervision enabled.	1	Ena warn (Enable warning) 0 = Disabled 1 = Enabled: Drive generates an alarm upon a stall condition.	2	Ena fault (Enable fault) 0 = Disabled 1 = Enabled: Drive trips on a fault upon a stall condition.
Bit	Function										
0	Ena sup (Enable supervision) 0 = Disabled: Supervision disabled. 1 = Enabled: Supervision enabled.										
1	Ena warn (Enable warning) 0 = Disabled 1 = Enabled: Drive generates an alarm upon a stall condition.										
2	Ena fault (Enable fault) 0 = Disabled 1 = Enabled: Drive trips on a fault upon a stall condition.										
30.10	Stall curr lim	Stall current limit in percent of the nominal current of the motor. See parameter 30.09 Stall function .									
	0.0 ... 1600.0%	Stall current limit.	10 = 1%								
30.11	Stall freq hi	Stall frequency limit. See parameter 30.09 Stall function .									
	0.5 ... 1000.0 Hz	Stall frequency limit.	10 = 1 Hz								
30.12	Stall time	Stall time. See parameter 30.09 Stall function .									
	0 ... 3600 s	Stall time.	1 = 1 s								

No.	Name/Value	Description	FbEq
31 Mot therm prot		Motor temperature measurement and thermal protection settings.	
31.01	Mot temp1 prot	Selects how the drive reacts when motor overtemperature is detected by motor thermal protection 1.	
	No	Motor thermal protection 1 inactive.	0
	Alarm	The drive generates alarm MOTOR TEMPERATURE when the temperature exceeds the alarm level defined by parameter 31.03 Mot temp1 almLim .	1
	Fault	The drive generates alarm MOTOR TEMPERATURE or trips on fault MOTOR OVERTEMP when the temperature exceeds the alarm/fault level defined by parameter 31.03 Mot temp1 almLim / 31.04 Mot temp1 fltLim (whichever is lower).	2
31.02	Mot temp1 src	Selects the means of temperature measurement for motor thermal protection 1. When overtemperature is detected the drive reacts as defined by parameter 31.01 Mot temp1 prot . Note: If one FEN-xx module is used, parameter setting must be either KTY 1st FEN or PTC 1st FEN. The FEN-xx module can be in either Slot 1 or Slot 2.	
	Estimated	The temperature is supervised based on the motor thermal protection model, which uses the motor thermal time constant (parameter 31.14 Mot therm time) and the motor load curve (parameters 31.10...31.12). User tuning is typically needed only if the ambient temperature differs from the normal operating temperature specified for the motor. The motor temperature increases if it operates in the region above the motor load curve. The motor temperature decreases if it operates in the region below the motor load curve (if the motor is overheated).  WARNING! The model does not protect the motor if it does not cool properly due to dust and dirt.	0
	KTY 1st FEN	The temperature is supervised using a KTY84 sensor connected to encoder interface module FEN-xx installed in drive Slot 1/2. If two encoder interface modules are used, encoder module connected to Slot 1 is used for the temperature supervision. Note: This selection does not apply to FEN-01.	2
	KTY 2nd FEN	The temperature is supervised using a KTY84 sensor connected to encoder interface module FEN-xx installed in drive Slot 1/2. If two encoder interface modules are used, encoder module connected to Slot 2 is used for the temperature supervision. Note: This selection does not apply to FEN-01.	3
	PTC JCU	The temperature is supervised using 1...3 PTC sensors connected to drive thermistor input TH.	4
	PTC 1st FEN	The temperature is supervised using a PTC sensor connected to encoder interface module FEN-xx installed in drive Slot 1/2. If two encoder interface modules are used, encoder module connected to Slot 1 is used for the temperature supervision.	5

178 Parameters

No.	Name/Value	Description	FbEq
	PTC 2nd FEN	The temperature is supervised using a PTC sensor connected to encoder interface module FEN-xx installed in drive Slot 1/2. If two encoder interface modules are used, encoder module connected to Slot 2 is used for the temperature supervision.	6
	Pt100 JCU x1	The temperature is supervised using a Pt100 sensor connected to analog input AI1 and analog output AO1 on the JCU Control Unit of the drive.	7
	Pt100 JCU x2	The temperature is supervised using two Pt100 sensors connected to analog input AI1 and analog output AO1 on the JCU Control Unit of the drive.	8
	Pt100 JCU x3	The temperature is supervised using three Pt100 sensors connected to analog input AI1 and analog output AI1 on the JCU Control Unit of the drive.	9
	Pt100 Ext x1	The temperature is supervised using a Pt100 sensor connected to the first available analog input and analog output on I/O extensions installed on the drive.	10
	Pt100 Ext x2	The temperature is supervised using two Pt100 sensors connected to the first available analog input and analog output on I/O extensions installed on the drive.	11
	Pt100 Ext x3	The temperature is supervised using three Pt100 sensors connected to the first available analog input and analog output on I/O extensions installed on the drive.	12
31.03	Mot temp1 almLim	Defines the alarm limit for motor thermal protection 1 (when parameter 31.01 Mot temp1 prot is set to either <i>Alarm</i> or <i>Fault</i>).	
	0 ... 200 °C	Motor overtemperature alarm limit.	1 = 1 °C
31.04	Mot temp1 fltLim	Defines the fault limit for the motor thermal protection 1 (when parameter 31.01 Mot temp1 prot is set to <i>Fault</i>).	
	0 ... 200 °C	Motor overtemperature fault limit.	1 = 1 °C
31.05	Mot temp2 prot	Selects how the drive reacts when motor overtemperature is detected by motor temperature protection 2.	
	No	Motor temperature protection 2 inactive.	0
	Alarm	The drive generates alarm MOTTEMPAL2 when the temperature exceeds the alarm level defined by parameter 31.07 Mot temp2 almLim .	1
	Fault	The drive generates alarm MOTTEMPAL2 or trips on fault MOTTEMP2 when the temperature exceeds the alarm/fault level defined by parameter 31.07 Mot temp2 almLim / 31.08 Mot temp2 fltLim (whichever is lower).	2

No.	Name/Value	Description	FbEq
31.06	Mot temp2 src	Selects the means of temperature measurement for motor thermal protection 2. When overtemperature is detected the drive reacts as defined by parameter 31.05 Mot temp2 prot . Note: If one FEN-xx module is used, parameter setting must be either KTY 1st FEN or PTC 1st FEN. The FEN-xx module can be in either Slot 1 or Slot 2.	
	Estimated	The temperature is supervised based on the motor thermal protection model, which uses the motor thermal time constant (parameter 31.14 Mot therm time) and the motor load curve (parameters 31.10...31.12). User tuning is typically needed only if the ambient temperature differs from the normal operating temperature specified for the motor. The motor temperature increases if it operates in the region above the motor load curve. The motor temperature decreases if it operates in the region below the motor load curve (if the motor is overheated).  WARNING! The model does not protect the motor if it does not cool properly due to dust and dirt.	0
	KTY 1st FEN	The temperature is supervised using a KTY84 sensor connected to encoder interface module FEN-xx installed in drive Slot 1/2. If two encoder interface modules are used, encoder module connected to Slot 1 is used for the temperature supervision. Note: This selection does not apply to FEN-01.	2
	KTY 2nd FEN	The temperature is supervised using a KTY84 sensor connected to encoder interface module FEN-xx installed in drive Slot 1/2. If two encoder interface modules are used, encoder module connected to Slot 2 is used for the temperature supervision. Note: This selection does not apply to FEN-01.	3
	PTC JCU	The temperature is supervised using 1...3 PTC sensors connected to drive thermistor input TH.	4
	PTC 1st FEN	The temperature is supervised using a PTC sensor connected to encoder interface module FEN-xx installed in drive Slot 1/2. If two encoder interface modules are used, encoder module connected to Slot 1 is used for the temperature supervision.	5
	PTC 2nd FEN	The temperature is supervised using a PTC sensor connected to encoder interface module FEN-xx installed in drive Slot 1/2. If two encoder interface modules are used, encoder module connected to Slot 2 is used for the temperature supervision.	6
	Pt100 JCU x1	The temperature is supervised using a Pt100 sensor connected to analog input AI1 and analog output AO1 on the JCU Control Unit of the drive.	7
	Pt100 JCU x2	The temperature is supervised using two Pt100 sensors connected to analog input AI1 and analog output AO1 on the JCU Control Unit of the drive.	8
	Pt100 JCU x3	The temperature is supervised using three Pt100 sensors connected to analog input AI1 and analog output AI1 on the JCU Control Unit of the drive.	9

No.	Name/Value	Description	FbEq
	Pt100 Ext x1	The temperature is supervised using a Pt100 sensor connected to the first available analog input and analog output on I/O extensions installed on the drive.	10
	Pt100 Ext x2	The temperature is supervised using two Pt100 sensors connected to the first available analog input and analog output on I/O extensions installed on the drive.	11
	Pt100 Ext x3	The temperature is supervised using three Pt100 sensors connected to the first available analog input and analog output on I/O extensions installed on the drive.	12
31.07	Mot temp2 almLim	Defines the alarm limit for the motor thermal protection 2 (when parameter 31.05 Mot temp2 prot is set to either <i>Alarm</i> or <i>Fault</i>).	
	0 ... 200 °C	Motor overtemperature alarm limit.	1 = 1 °C
31.08	Mot temp2 fltLim	Defines the fault limit for the motor thermal protection 2 (when parameter 31.05 Mot temp2 prot is set to <i>Fault</i>).	
	0 ... 200 °C	Motor overtemperature fault limit.	1 = 1 °C
31.09	Mot ambient temp	Defines the ambient temperature for the thermal protection mode.	
	-60 ... 100 °C	Ambient temperature.	1 = 1 °C
31.10	Mot load curve	Defines the load curve together with parameters 31.11 Zero speed load and 31.12 Break point When the parameter is set to 100%, the maximum load is equal to the value of parameter 99.06 Mot nom current (higher loads heat up the motor). The load curve level should be adjusted if the ambient temperature differs from the nominal value. The load curve is used by the motor thermal protection model when parameter 31.02 Mot temp1 src is set to <i>Estimated</i> .	
		<p> $I =$ Motor current $I_N =$ Nominal motor current </p>	
	50 ... 150%	Maximum load for the motor load curve.	1 = 1%

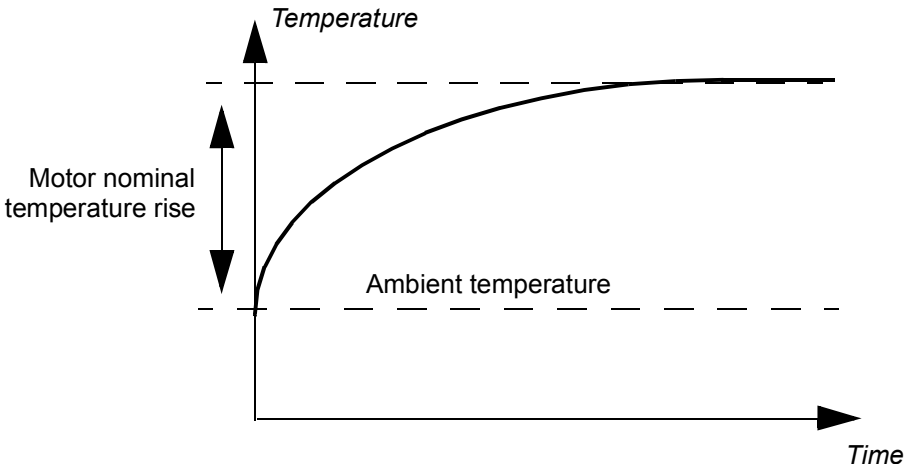
No.	Name/Value	Description	FbEq
31.11	Zero speed load	Defines the motor load curve together with parameters 31.10 Mot load curve and 31.12 Break point . Defines the maximum motor load at zero speed of the load curve. A higher value can be used if the motor has an external motor fan to boost the cooling. See the motor manufacturer's recommendations. See parameter 31.10 Mot load curve .	
	50 ... 150%	Zero speed load for the motor load curve.	1 = 1%
31.12	Break point	Defines the motor load curve together with parameters 31.10 Mot load curve and 31.11 Zero speed load . Defines the break point frequency of the load curve i.e. the point at which the motor load curve begins to decrease from the value of parameter 31.10 Mot load curve towards the value of parameter 31.11 Zero speed load . See parameter 31.10 Mot load curve .	
	0.01 ... 500.00 Hz	Break point for the motor load curve.	100 = 1 Hz
31.13	Mot nom tempRise	Defines the temperature rise of the motor when the motor is loaded with nominal current. See the motor manufacturer's recommendations. The temperature rise value is used by the motor thermal protection model when parameter 31.02 Mot temp1 src is set to Estimated .	
			
	0 ... 300 °C	Temperature rise.	1 = 1 °C

No.	Name/Value	Description	FbEq
31.14	Mot therm time	<p>Defines the thermal time constant for the motor thermal protection model (i.e. time inside which the temperature has reached 63% of the nominal temperature). See the motor manufacturer's recommendations.</p> <p>The motor thermal protection model is used when parameter 31.02 Mot temp1 src is set to <i>Estimated</i>.</p>	
	100 ... 10000 s	Motor thermal time constant.	1 = 1 s

32 Automatic reset		Defines conditions for automatic fault resets.															
32.01	Autoreset sel	<p>Selects faults that are automatically reset. The parameter is a 16-bit word with each bit corresponding to a fault type. Whenever a bit is set to 1, the corresponding fault is automatically reset.</p> <p>The bits of the binary number correspond to the following faults:</p>															
<table border="1" style="width: 100%; border-collapse: collapse;"> <thead> <tr> <th style="width: 10%;">Bit</th> <th>Fault</th> </tr> </thead> <tbody> <tr> <td>0</td> <td>Overcurrent</td> </tr> <tr> <td>1</td> <td>Overvoltage</td> </tr> <tr> <td>2</td> <td>Undervoltage</td> </tr> <tr> <td>3</td> <td>AI min</td> </tr> <tr> <td>4</td> <td>Line converter</td> </tr> <tr> <td>5</td> <td>External fault</td> </tr> </tbody> </table>				Bit	Fault	0	Overcurrent	1	Overvoltage	2	Undervoltage	3	AI min	4	Line converter	5	External fault
Bit	Fault																
0	Overcurrent																
1	Overvoltage																
2	Undervoltage																
3	AI min																
4	Line converter																
5	External fault																
32.02	Number of trials	Defines the number of automatic fault resets the drive performs within the time defined by parameter 32.03 Trial time .															
	0 ... 5	Number of automatic resets.	1 = 1														
32.03	Trial time	Defines the time for the automatic fault reset function. See parameter 32.02 Number of trials .															
	1.0 ... 600.0 s	Time for automatic resets.	10 = 1 s														

No.	Name/Value	Description	FbEq
32.04	Delay time	Defines the time that the drive will wait after a fault before attempting an automatic reset. See parameter 32.01 Autoreset sel.	
	0.0 ... 120.0 s	Resetting delay.	10 = 1 s
33 Supervision		Configuration of signal supervision.	
33.01	Superv1 func	Selects the mode of supervision 1.	
	Disabled	Supervision 1 not in use.	0
	Low	When the signal selected by parameter 33.02 Superv1 act falls below the value of parameter 33.04 Superv1 lo , bit 0 of 06.13 Superv status is activated. To clear the bit, the signal must exceed the value of parameter 33.03 Superv1 hi .	1
	High	When the signal selected by parameter 33.02 Superv1 act exceeds the value of parameter 33.03 Superv1 hi , bit 0 of 06.13 Superv status is activated. To clear the bit, the signal must fall below the value of parameter 33.04 Superv1 lo .	2
	Abs Low	When the absolute value of the signal selected by parameter 33.02 Superv1 act falls below the value of parameter 33.04 Superv1 lo , bit 0 of 06.13 Superv status is activated. To clear the bit, the absolute value of the signal must exceed the value of parameter 33.03 Superv1 hi .	3
	Abs High	When the absolute value of the signal selected by parameter 33.02 Superv1 act exceeds the value of parameter 33.03 Superv1 hi , bit 0 of 06.13 Superv status is activated. To clear the bit, the absolute value of the signal must fall below the value of parameter 33.04 Superv1 lo .	4
33.02	Superv1 act	Selects the signal to be monitored by supervision 1. See parameter 33.01 Superv1 func .	
	Speed rpm	01.01 Motor speed rpm (see page 94).	1073742081
	Speed %	01.02 Motor speed % (see page 94).	1073742082
	Frequency	01.03 Output frequency (see page 94).	1073742083
	Current	01.04 Motor current (see page 94).	1073742084
	Current %	01.05 Motor current % (see page 94).	1073742085
	Torque	01.06 Motor torque (see page 94).	1073742086
	Dc-voltage	01.07 Dc-voltage (see page 94).	1073742087
	Power inu	01.22 Power inu out (see page 94).	1073742102
	Power motor	01.23 Motor power (see page 94).	1073742103
	SpRef unramp	03.03 SpeedRef unramp (see page 101).	1073742595
	SpRef ramped	03.05 SpeedRef ramped (see page 101).	1073742597
	SpRef used	03.06 SpeedRef used (see page 101).	1073742598
	TorqRef used	03.14 Torq ref used (see page 101).	1073742606
	Process act	04.03 Process act (see page 102).	1073742851
	Proc PID out	04.05 Process PID out (see page 102).	1073742853
	Pointer	Value pointer setting (see Terms and abbreviations on page 93).	-

184 Parameters

No.	Name/Value	Description	FbEq
33.03	Superv1 hi	Selects the upper limit for supervision 1. See parameter 33.01 Superv1 func.	
	-32768.00 ... 32768.00	Upper limit for supervision 1.	100 = 1
33.04	Superv1 lo	Selects the lower limit for supervision 1. See parameter 33.01 Superv1 func.	
	-32768.00 ... 32768.00	Lower limit for supervision 1.	100 = 1
33.05	Superv2 func	Selects the mode of supervision 2.	
	Disabled	Supervision 2 not in use.	0
	Low	When the signal selected by parameter 33.06 Superv2 act falls below the value of parameter 33.08 Superv2 lo , bit 1 of 06.13 Superv status is activated. To clear the bit, the signal must exceed the value of parameter 33.07 Superv2 hi .	1
	High	When the signal selected by parameter 33.06 Superv2 act exceeds the value of parameter 33.07 Superv2 hi , bit 1 of 06.13 Superv status is activated. To clear the bit, the signal must fall below the value of parameter 33.08 Superv2 lo .	2
	Abs Low	When the absolute value of the signal selected by parameter 33.06 Superv2 act falls below the value of parameter 33.08 Superv2 lo , bit 1 of 06.13 Superv status is activated. To clear the bit, the absolute value of the signal must exceed the value of parameter 33.07 Superv2 hi .	3
	Abs High	When the absolute value of the signal selected by parameter 33.06 Superv2 act exceeds the value of parameter 33.07 Superv2 hi , bit 1 of 06.13 Superv status is activated. To clear the bit, the absolute value of the signal must fall below the value of parameter 33.08 Superv2 lo .	4
33.06	Superv2 act	Selects the signal to be monitored by supervision 2. See parameter 33.05 Superv2 func.	
	Speed rpm	01.01 Motor speed rpm (see page 94).	1073742081
	Speed %	01.02 Motor speed % (see page 94).	1073742082
	Frequency	01.03 Output frequency (see page 94).	1073742083
	Current	01.04 Motor current (see page 94).	1073742084
	Current %	01.05 Motor current % (see page 94).	1073742085
	Torque	01.06 Motor torque (see page 94).	1073742086
	Dc-voltage	01.07 Dc-voltage (see page 94).	1073742087
	Power inu	01.22 Power inu out (see page 94).	1073742102
	Power motor	01.23 Motor power (see page 94).	1073742103
	SpRef unramp	03.03 SpeedRef unramp (see page 101).	1073742595
	SpRef ramped	03.05 SpeedRef ramped (see page 101).	1073742597
	SpRef used	03.06 SpeedRef used (see page 101).	1073742598
	TorqRef used	03.14 Torq ref used (see page 101).	1073742606
	Process act	04.03 Process act (see page 102).	1073742851
	Proc PID out	04.05 Process PID out (see page 102).	1073742853
	Pointer	Value pointer setting (see Terms and abbreviations on page 93).	-

No.	Name/Value	Description	FbEq
33.07	Superv2 hi	Selects the upper limit for supervision 2. See parameter 33.05 Superv2 func.	
	-32768.00 ... 32768.00	Upper limit for supervision 2.	100 = 1
33.08	Superv2 lo	Selects the lower limit for supervision 2. See parameter 33.05 Superv2 func.	
	-32768.00 ... 32768.00	Lower limit for supervision 2.	100 = 1
33.09	Superv3 func	Selects the mode of supervision 3.	
	Disabled	Supervision 3 not in use.	0
	Low	When the signal selected by parameter 33.10 Superv3 act falls below the value of parameter 33.12 Superv3 lo , bit 2 of 06.13 Superv status is activated. To clear the bit, the signal must exceed the value of parameter 33.11 Superv3 hi .	1
	High	When the signal selected by parameter 33.10 Superv2 act exceeds the value of parameter 33.11 Superv3 hi , bit 2 of 06.13 Superv status is activated. To clear the bit, the signal must fall below the value of parameter 33.12 Superv3 lo .	2
	Abs Low	When the absolute value of the signal selected by parameter 33.10 Superv3 act falls below the value of parameter 33.12 Superv3 lo , bit 2 of 06.13 Superv status is activated. To clear the bit, the absolute value of the signal must exceed the value of parameter 33.11 Superv3 hi .	3
	Abs High	When the absolute value of the signal selected by parameter 33.10 Superv2 act exceeds the value of parameter 33.11 Superv3 hi , bit 2 of 06.13 Superv status is activated. To clear the bit, the absolute value of the signal must fall below the value of parameter 33.12 Superv3 lo .	4
33.10	Superv3 act	Selects the signal to be monitored by supervision 3. See parameter 33.09 Superv3 func.	
	Speed rpm	01.01 Motor speed rpm (see page 94).	1073742081
	Speed %	01.02 Motor speed % (see page 94).	1073742082
	Frequency	01.03 Output frequency (see page 94).	1073742083
	Current	01.04 Motor current (see page 94).	1073742084
	Current %	01.05 Motor current % (see page 94).	1073742085
	Torque	01.06 Motor torque (see page 94).	1073742086
	Dc-voltage	01.07 Dc-voltage (see page 94).	1073742087
	Power inu	01.22 Power inu out (see page 94).	1073742102
	Power motor	01.23 Motor power (see page 94).	1073742103
	SpRef unramp	03.03 SpeedRef unramp (see page 101).	1073742595
	SpRef ramped	03.05 SpeedRef ramped (see page 101).	1073742597
	SpRef used	03.06 SpeedRef used (see page 101).	1073742598
	TorqRef used	03.14 Torq ref used (see page 101).	1073742606
	Process act	04.03 Process act (see page 102).	1073742851
	Proc PID out	04.05 Process PID out (see page 102).	1073742853
	Pointer	Value pointer setting (see Terms and abbreviations on page 93).	-

No.	Name/Value	Description	FbEq
33.11	Superv3 hi	Selects the upper limit for supervision 3. See parameter 33.09 Superv3 func.	
	-32768.00 ... 32768.00	Upper limit for supervision 3.	100 = 1
33.12	Superv3 lo	Selects the lower limit for supervision 3. See parameter 33.09 Superv3 func.	
	-32768.00 ... 32768.00	Lower limit for supervision 3.	100 = 1

34 User load curve		Definition of user load curve. See also section User-definable load curve on page 79 .	
34.01	Overload func	Configures the supervision of the upper boundary of the user load curve.	
Bit	Function		
0	Ena sup (Enable supervision) 0 = Disabled: Supervision disabled. 1 = Enabled: Supervision enabled.		
1	Input value sel (Input value selection) 0 = Current: Current is supervised. 1 = Torque: Torque is supervised.		
2	Ena warn (Enable warning) 0 = Disabled 1 = Enabled: Drive generates an alarm when the curve is exceeded.		
3	Ena fault (Enable fault) 0 = Disabled 1 = Enabled: Drive trips on a fault when the curve is exceeded.		
4	Ena lim integ (Enable limit integration) 0 = Disabled 1 = Enabled: Integration time defined by parameter 34.18 Load integ time is used. After the supervision is evoked, the current or torque is limited by the upper boundary of the load curve.		
5	Ena lim always (Enable limit always) 0 = Disabled 1 = Enabled: The current or torque is always limited by the upper boundary of the load curve.		

No.	Name/Value	Description	FbEq
34.02	Underload func	Configures the supervision of the lower boundary of the user load curve.	
	Bit	Function	
	0	Ena sup (Enable supervision) 0 = Disabled: Supervision disabled. 1 = Enabled: Supervision enabled.	
	1	Input value sel (Input value selection) 0 = Current: Current is supervised. 1 = Torque: Torque is supervised.	
	2	Ena warn (Enable warning) 0 = Disabled 1 = Enabled: Drive generates an alarm when the load remains below the curve for longer than the time defined by parameter 34.20 Underload time .	
	3	Ena fault (Enable fault) 0 = Disabled 1 = Enabled: Drive trips on a fault when the load remains below the curve for longer than the time defined by parameter 34.20 Underload time .	
34.03	Load freq1	Drive output frequency at point 1 of user load curve.	
	1 ... 500 Hz	Frequency at point 1.	1 = 1 Hz
34.04	Load freq2	Drive output frequency at point 2 of user load curve.	
	1 ... 500 Hz	Frequency at point 2.	1 = 1 Hz
34.05	Load freq3	Drive output frequency at point 3 of user load curve.	
	1 ... 500 Hz	Frequency at point 3.	1 = 1 Hz
34.06	Load freq4	Drive output frequency at point 4 of user load curve.	
	1 ... 500 Hz	Frequency at point 4.	1 = 1 Hz
34.07	Load freq5	Drive output frequency at point 5 of user load curve.	
	1 ... 500 Hz	Frequency at point 5.	1 = 1 Hz
34.08	Load low lim1	Minimum load (current or torque) at point 1 of user load curve.	
	0 ... 1600%	Minimum load at point 1.	1 = 1%
34.09	Load low lim2	Minimum load (current or torque) at point 2 of user load curve.	
	0 ... 1600%	Minimum load at point 2.	1 = 1%
34.10	Load low lim3	Minimum load (current or torque) at point 3 of user load curve.	
	0 ... 1600%	Minimum load at point 3.	1 = 1%
34.11	Load low lim4	Minimum load (current or torque) at point 4 of user load curve.	
	0 ... 1600%	Minimum load at point 4.	1 = 1%
34.12	Load low lim5	Minimum load (current or torque) at point 5 of user load curve.	
	0 ... 1600%	Minimum load at point 5.	1 = 1%
34.13	Load high lim1	Maximum load (current or torque) at point 1 of user load curve.	
	0 ... 1600%	Maximum load at point 1.	1 = 1%

No.	Name/Value	Description	FbEq
34.14	Load high lim2	Maximum load (current or torque) at point 2 of user load curve.	
	0 ... 1600%	Maximum load at point 2.	1 = 1%
34.15	Load high lim3	Maximum load (current or torque) at point 3 of user load curve.	
	0 ... 1600%	Maximum load at point 3.	1 = 1%
34.16	Load high lim4	Maximum load (current or torque) at point 4 of user load curve.	
	0 ... 1600%	Maximum load at point 4.	1 = 1%
34.17	Load high lim5	Maximum load (current or torque) at point 5 of user load curve.	
	0 ... 1600%	Maximum load at point 5.	1 = 1%
34.18	Load integ time	Integration time used in limit supervision whenever enabled by parameter 34.01/34.02 .	
	0 ... 10000 s	Integration time.	1 = 1 s
34.19	Load cool time	Defines the cooling time. The output of the overload integrator is set to zero if the load stays continuously below the upper boundary of the user load curve.	
	0 ... 10000 s	Load cooling time.	1 = 1 s
34.20	Underload time	Time for the underload function. See parameter 34.02 Underload func .	
	0 ... 10000 s	Underload time.	1 = 1 s
35 Process variable		Selection and modification of process variables for display as parameters 04.06 ... 04.08 .	
35.01	Signal1 param	Selects a signal to be provided as parameter 04.06 Process var1 .	
	Speed rpm	01.01 Motor speed rpm (see page 94).	1073742081
	Speed %	01.02 Motor speed % (see page 94).	1073742082
	Frequency	01.03 Output frequency (see page 94).	1073742083
	Current	01.04 Motor current (see page 94).	1073742084
	Current %	01.05 Motor current % (see page 94).	1073742085
	Torque	01.06 Motor torque (see page 94).	1073742086
	Dc-voltage	01.07 Dc-voltage (see page 94).	1073742087
	Power inu	01.22 Power inu out (see page 94).	1073742102
	Power motor	01.23 Motor power (see page 94).	1073742103
	SpRef unramp	03.03 SpeedRef unramp (see page 101).	1073742595
	SpRef ramped	03.05 SpeedRef ramped (see page 101).	1073742597
	SpRef used	03.06 SpeedRef used (see page 101).	1073742598
	TorqRef used	03.14 Torq ref used (see page 101).	1073742606
	Process act	04.03 Process act (see page 102).	1073742851
	Proc PID out	04.05 Process PID out (see page 102).	1073742853
	Pointer	Value pointer setting (see Terms and abbreviations on page 93).	-

No.	Name/Value	Description	FbEq
35.02	Signal1 max	<p>Defines the real value of the selected signal that corresponds to the maximum display value defined by parameter 35.06 Proc var1 max.</p> <p>04.06 Process var1</p> <p>Signal selected by 35.01 Signal1 param</p>	
	-32768...32768	Real signal value corresponding to maximum process variable 1 value.	1 = 1
35.03	Signal1 min	<p>Defines the real value of the selected signal that corresponds to the minimum display value defined by parameter 35.07 Proc var1 min. See diagram at parameter 35.02 Signal1 max.</p>	
	-32768...32768	Real signal value corresponding to minimum process variable 1 value.	1 = 1
35.04	Proc var1 dispf	Scaling for process variable 1. This setting also scales the value for fieldbus.	
	0	1 = 1	0
	1	10 = 1	1
	2	100 = 1	2
	3	1000 = 1	3
	4	10000 = 1	4
	5	100000 = 1	5
35.05	Proc var1 unit	Specifies the unit for parameter 04.06 Process var1 (process variable 1).	
	0	None	0
	1	A	1
	2	V	2
	3	Hz	3
	4	%	4
	5	s	5
	6	h	6
	7	rpm	7
	8	kh	8
	9	C	9
	10	lbft	10
	11	mA	11
	12	mV	12

190 Parameters

No.	Name/Value	Description	FbEq
13		kW	13
14		W	14
15		kWh	15
16		F	16
17		hp	17
18		MWh	18
19		m/s	19
20		m ³ /h	20
21		dm ³ /h	21
22		bar	22
23		kPa	23
24		GPM	24
25		PSI	25
26		CFM	26
27		ft	27
28		MGD	28
29		inHg	29
30		FPM	30
31		kbits	31
32		kHz	32
33		Ohm	33
34		ppm	34
35		pps	35
36		l/s	36
37		l/min	37
38		l/h	38
39		m ³ /s	39
40		m ³ /m	40
41		kg/s	41
42		kg/m	42
43		kg/h	43
44		mbar	44
45		Pa	45
46		GPS	46
47		gal/s	47
48		gal/m	48
49		gal/h	49
50		ft ³ /s	50
51		ft ³ /m	51
52		ft ³ /h	52
53		lb/s	53

No.	Name/Value	Description	FbEq
54		lb/m	54
55		lb/h	55
56		FPS	56
57		ft/s	57
58		inH2O	58
59		inwg	59
60		ftwg	60
61		lbsi	61
62		ms	62
63		Mrev	63
64		days	64
65		inWC	65
66		mpmin	66
67		week	67
68		tonne	68
69		m/s ²	66
70		rev	70
71		deg	71
72		m	72
73		inch	73
74		inc	74
75		m/s ³	75
76		kg/m ²	76
77		kg/m ³	77
78		m ³	78
79		[blank]	79
80		u/s	80
81		u/min	81
82		u/h	82
83...84		[blank]	83...84
85		u/s ²	85
86		min-2	86
87		u/h ²	87
88...89		[blank]	88...89
90		Vrms	90
91		bits	91
92		Nm	92
93		p.u.	93
94		1/s	94
95		mH	95
96		mOhm	96

192 Parameters

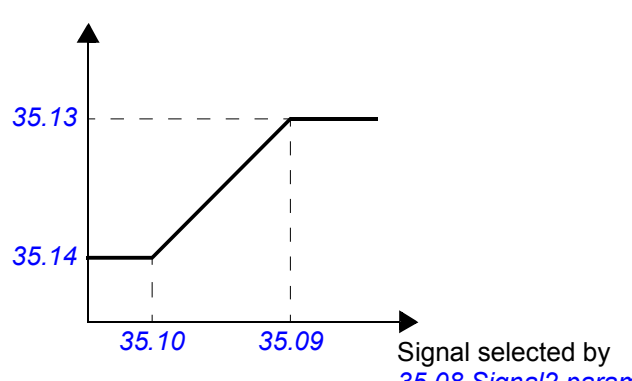
No.	Name/Value	Description	FbEq
	97	us	97
	98	C/W	98
35.06	Proc var1 max	Maximum value for process variable 1. See diagram at parameter 35.02 Signal1 max .	
	-32768...32768	Maximum value for process variable 1.	1 = 1
35.07	Proc var1 min	Minimum value for process variable 1. See diagram at parameter 35.02 Signal1 max .	
	-32768...32768	Minimum value for process variable 1.	1 = 1
35.08	Signal2 param	Selects a signal to be provided as parameter 04.07 Process var2 .	
	Speed rpm	01.01 Motor speed rpm (see page 94).	1073742081
	Speed %	01.02 Motor speed % (see page 94).	1073742082
	Frequency	01.03 Output frequency (see page 94).	1073742083
	Current	01.04 Motor current (see page 94).	1073742084
	Current %	01.05 Motor current % (see page 94).	1073742085
	Torque	01.06 Motor torque (see page 94).	1073742086
	Dc-voltage	01.07 Dc-voltage (see page 94).	1073742087
	Power inu	01.22 Power inu out (see page 94).	1073742102
	Power motor	01.23 Motor power (see page 94).	1073742103
	SpRef unramp	03.03 SpeedRef unramp (see page 101).	1073742595
	SpRef ramped	03.05 SpeedRef ramped (see page 101).	1073742597
	SpRef used	03.06 SpeedRef used (see page 101).	1073742598
	TorqRef used	03.14 Torq ref used (see page 101).	1073742606
	Process act	04.03 Process act (see page 102).	1073742851
	Proc PID out	04.05 Process PID out (see page 102).	1073742853
	Pointer	Value pointer setting (see Terms and abbreviations on page 93).	-
35.09	Signal2 max	Defines the real value of the selected signal that corresponds to the maximum display value defined by parameter 35.13 Proc var2 max . <i>04.07 Process var2</i> 	
	-32768...32768	Real signal value corresponding to maximum process variable 2 value.	1 = 1

No.	Name/Value	Description	FbEq
35.10	Signal2 min	Defines the real value of the selected signal that corresponds to the minimum display value defined by parameter 35.14 Proc var2 min . See diagram at parameter 35.09 Signal2 max .	
	-32768...32768	Real signal value corresponding to minimum process variable 2 value.	1 = 1
35.11	Proc var2 dispf	Scaling for process variable 2. This setting also scales the value for fieldbus.	
	0	1 = 1	0
	1	10 = 1	1
	2	100 = 1	2
	3	1000 = 1	3
	4	10000 = 1	4
	5	100000 = 1	5
35.12	Proc var2 unit	Specifies the unit for parameter 04.07 Process var2 (process variable 2).	
	0...98	See parameter 35.05 Proc var1 unit .	1 = 1
35.13	Proc var2 max	Maximum value for process variable 2. See diagram at parameter 35.09 Signal2 max .	
	-32768...32768	Maximum value for process variable 2.	1 = 1
35.14	Proc var2 min	Minimum value for process variable 2. See diagram at parameter 35.09 Signal2 max .	
	-32768...32768	Minimum value for process variable 2.	1 = 1
35.15	Signal3 param	Selects a signal to be provided as parameter 04.08 Process var3 .	
	Speed rpm	01.01 Motor speed rpm (see page 94).	1073742081
	Speed %	01.02 Motor speed % (see page 94).	1073742082
	Frequency	01.03 Output frequency (see page 94).	1073742083
	Current	01.04 Motor current (see page 94).	1073742084
	Current %	01.05 Motor current % (see page 94).	1073742085
	Torque	01.06 Motor torque (see page 94).	1073742086
	Dc-voltage	01.07 Dc-voltage (see page 94).	1073742087
	Power inu	01.22 Power inu out (see page 94).	1073742102
	Power motor	01.23 Motor power (see page 94).	1073742103
	SpRef unramp	03.03 SpeedRef unramp (see page 101).	1073742595
	SpRef ramped	03.05 SpeedRef ramped (see page 101).	1073742597
	SpRef used	03.06 SpeedRef used (see page 101).	1073742598
	TorqRef used	03.14 Torq ref used (see page 101).	1073742606
	Process act	04.03 Process act (see page 102).	1073742851
	Proc PID out	04.05 Process PID out (see page 102).	1073742853
	Pointer	Value pointer setting (see Terms and abbreviations on page 93).	-

No.	Name/Value	Description	FbEq
35.16	Signal3 max	<p>Defines the real value of the selected signal that corresponds to the maximum display value defined by parameter 35.20 Proc var3 max.</p> <p><i>04.08 Process var3</i></p>	
	-32768...32768	Real signal value corresponding to maximum process variable 3 value.	1 = 1
35.17	Signal3 min	Defines the real value of the selected signal that corresponds to the minimum display value defined by parameter 35.21 Proc var3 min . See diagram at parameter 35.16 Signal3 max .	
	-32768...32768	Real signal value corresponding to minimum process variable 3 value.	1 = 1
35.18	Proc var3 dispf	Scaling for process variable 3. This setting also scales the value for fieldbus.	
	0	1 = 1	0
	1	10 = 1	1
	2	100 = 1	2
	3	1000 = 1	3
	4	10000 = 1	4
	5	100000 = 1	5
35.19	Proc var3 unit	Specifies the unit for parameter <i>04.08 Process var3</i> (process variable 3).	
	0...98	See parameter 35.05 Proc var1 unit .	1 = 1
35.20	Proc var3 max	Maximum value for process variable 3. See diagram at parameter 35.16 Signal3 max .	
	-32768...32768	Maximum value for process variable 3.	1 = 1
35.21	Proc var3 min	Minimum value for process variable 3. See diagram at parameter 35.16 Signal3 max .	
	-32768...32768	Minimum value for process variable 3.	1 = 1
36 Timed functions		Configuration of timers. See also section Timers on page 77 .	
36.01	Timers enable	Enable/disable control for timers. Whenever the source selected by this parameter is off, timers are disabled; when the source is on, timers are enabled.	
	DI1	Digital input DI1 (as indicated by 02.01 DI status , bit 0).	1073742337
	DI2	Digital input DI2 (as indicated by 02.01 DI status , bit 1).	1073807873

No.	Name/Value	Description	FbEq										
	DI3	Digital input DI3 (as indicated by 02.01 DI status , bit 2).	1073873409										
	DI4	Digital input DI4 (as indicated by 02.01 DI status , bit 3).	1073938945										
	DI5	Digital input DI5 (as indicated by 02.01 DI status , bit 4).	1074004481										
	DI6	Digital input DI6 (as indicated by 02.01 DI status , bit 5).	1074070017										
	DIO4	Digital input/output DIO4 (as indicated by 02.03 DIO status , bit 3).	1073938947										
	DIO5	Digital input/output DIO5 (as indicated by 02.03 DIO status , bit 4).	1074004483										
	DIO6	Digital input/output DIO6 (as indicated by 02.03 DIO status , bit 5).	1074070019										
	Const	Bit pointer setting (see Terms and abbreviations on page 93).	-										
	Pointer												
36.02	Timers mode	Specifies whether the time periods defined by parameters 36.03 Start time1 ... 36.18 Stop day4 are valid daily or weekly.											
		<table border="1"> <thead> <tr> <th>Bit</th> <th>Function</th> </tr> </thead> <tbody> <tr> <td>0</td> <td>Timer1 mode 0 = Daily 1 = Weekly</td> </tr> <tr> <td>1</td> <td>Timer2 mode 0 = Daily 1 = Weekly</td> </tr> <tr> <td>2</td> <td>Timer3 mode 0 = Daily 1 = Weekly</td> </tr> <tr> <td>3</td> <td>Timer4 mode 0 = Daily 1 = Weekly</td> </tr> </tbody> </table>	Bit	Function	0	Timer1 mode 0 = Daily 1 = Weekly	1	Timer2 mode 0 = Daily 1 = Weekly	2	Timer3 mode 0 = Daily 1 = Weekly	3	Timer4 mode 0 = Daily 1 = Weekly	
Bit	Function												
0	Timer1 mode 0 = Daily 1 = Weekly												
1	Timer2 mode 0 = Daily 1 = Weekly												
2	Timer3 mode 0 = Daily 1 = Weekly												
3	Timer4 mode 0 = Daily 1 = Weekly												
36.03	Start time1	Defines the start time for time period 1.											
	00:00:00 ... 24:00:00	Start time for time period 1.	1 = 1 s (24:00:00 = 86400)										
36.04	Stop time1	Defines the stop time for time period 1.											
	00:00:00 ... 24:00:00	Stop time for time period 1.	1 = 1 s (24:00:00 = 86400)										
36.05	Start day1	Defines the week day on which time period 1 begins.											
	Monday	Time period 1 starts on Monday.	1										
	Tuesday	Time period 1 starts on Tuesday.	2										
	Wednesday	Time period 1 starts on Wednesday.	3										
	Thursday	Time period 1 starts on Thursday.	4										
	Friday	Time period 1 starts on Friday.	5										
	Saturday	Time period 1 starts on Saturday.	6										
	Sunday	Time period 1 starts on Sunday.	7										
36.06	Stop day1	Defines the week day on which time period 1 ends.											
	Monday	Time period 1 ends on Monday.	1										
	Tuesday	Time period 1 ends on Tuesday.	2										

No.	Name/Value	Description	FbEq
	Wednesday	Time period 1 ends on Wednesday.	3
	Thursday	Time period 1 ends on Thursday.	4
	Friday	Time period 1 ends on Friday.	5
	Saturday	Time period 1 ends on Saturday.	6
	Sunday	Time period 1 ends on Sunday.	7
36.07	Start time2	Defines the start time for time period 2.	
	00:00:00 ... 24:00:00	Start time for time period 2.	1 = 1 s (24:00:00 = 86400)
36.08	Stop time2	Defines the stop time for time period 2.	
	00:00:00 ... 24:00:00	Stop time for time period 2.	1 = 1 s (24:00:00 = 86400)
36.09	Start day2	Defines the week day on which time period 2 begins.	
	Monday	Time period 2 starts on Monday.	1
	Tuesday	Time period 2 starts on Tuesday.	2
	Wednesday	Time period 2 starts on Wednesday.	3
	Thursday	Time period 2 starts on Thursday.	4
	Friday	Time period 2 starts on Friday.	5
	Saturday	Time period 2 starts on Saturday.	6
	Sunday	Time period 2 starts on Sunday.	7
36.10	Stop day2	Defines the week day on which time period 2 ends.	
	Monday	Time period 2 ends on Monday.	1
	Tuesday	Time period 2 ends on Tuesday.	2
	Wednesday	Time period 2 ends on Wednesday.	3
	Thursday	Time period 2 ends on Thursday.	4
	Friday	Time period 2 ends on Friday.	5
	Saturday	Time period 2 ends on Saturday.	6
	Sunday	Time period 2 ends on Sunday.	7
36.11	Start time3	Defines the start time for time period 3.	
	00:00:00 ... 24:00:00	Start time for time period 3.	1 = 1 s (24:00:00 = 86400)
36.12	Stop time3	Defines the stop time for time period 3.	
	00:00:00 ... 24:00:00	Stop time for time period 3.	1 = 1 s (24:00:00 = 86400)
36.13	Start day3	Defines the week day on which time period 3 begins.	
	Monday	Time period 3 starts on Monday.	1
	Tuesday	Time period 3 starts on Tuesday.	2
	Wednesday	Time period 3 starts on Wednesday.	3
	Thursday	Time period 3 starts on Thursday.	4
	Friday	Time period 3 starts on Friday.	5
	Saturday	Time period 3 starts on Saturday.	6

No.	Name/Value	Description	FbEq
	Sunday	Time period 3 starts on Sunday.	7
36.14	Stop day3	Defines the week day on which time period 3 ends.	
	Monday	Time period 3 ends on Monday.	1
	Tuesday	Time period 3 ends on Tuesday.	2
	Wednesday	Time period 3 ends on Wednesday.	3
	Thursday	Time period 3 ends on Thursday.	4
	Friday	Time period 3 ends on Friday.	5
	Saturday	Time period 3 ends on Saturday.	6
	Sunday	Time period 3 ends on Sunday.	7
36.15	Start time4	Defines the start time for time period 4.	
	00:00:00 ... 24:00:00	Start time for time period 4.	1 = 1 s (24:00:00 = 86400)
36.16	Stop time4	Defines the stop time for time period 4.	
	00:00:00 ... 24:00:00	Stop time for time period 4.	1 = 1 s (24:00:00 = 86400)
36.17	Start day4	Defines the week day on which time period 4 begins.	
	Monday	Time period 4 starts on Monday.	1
	Tuesday	Time period 4 starts on Tuesday.	2
	Wednesday	Time period 4 starts on Wednesday.	3
	Thursday	Time period 4 starts on Thursday.	4
	Friday	Time period 4 starts on Friday.	5
	Saturday	Time period 4 starts on Saturday.	6
	Sunday	Time period 4 starts on Sunday.	7
36.18	Stop day4	Defines the week day on which time period 4 ends.	
	Monday	Time period 4 ends on Monday.	1
	Tuesday	Time period 4 ends on Tuesday.	2
	Wednesday	Time period 4 ends on Wednesday.	3
	Thursday	Time period 4 ends on Thursday.	4
	Friday	Time period 4 ends on Friday.	5
	Saturday	Time period 4 ends on Saturday.	6
	Sunday	Time period 4 ends on Sunday.	7
36.19	Boost signal	Boosting can be used to extend the timer enable signal for the time defined by parameter 36.20 Boost time . The boost time starts when the boost signal changes state from 1 to 0.	
	DI1	Digital input DI1 (as indicated by 02.01 DI status , bit 0).	1073742337
	DI2	Digital input DI2 (as indicated by 02.01 DI status , bit 1).	1073807873
	DI3	Digital input DI3 (as indicated by 02.01 DI status , bit 2).	1073873409
	DI4	Digital input DI4 (as indicated by 02.01 DI status , bit 3).	1073938945
	DI5	Digital input DI5 (as indicated by 02.01 DI status , bit 4).	1074004481
	DI6	Digital input DI6 (as indicated by 02.01 DI status , bit 5).	1074070017

No.	Name/Value	Description	FbEq												
	DIO4	Digital input/output DIO4 (as indicated by 02.03 DIO status , bit 3).	1073938947												
	DIO5	Digital input/output DIO5 (as indicated by 02.03 DIO status , bit 4).	1074004483												
	DIO6	Digital input/output DIO6 (as indicated by 02.03 DIO status , bit 5).	1074070019												
	Const	Bit pointer setting (see Terms and abbreviations on page 93).	-												
	Pointer														
36.20	Boost time	Boost time. See parameter 36.19 Boost signal .													
	00:00:00 ... 24:00:00	Boost time.	1 = 1 s (24:00:00 = 86400)												
36.21	Timed func1	<p>Selects which time periods (1...4) are used with timed function 1. Also determines whether boost is used with timed function 1.</p> <p>The parameter is a 16-bit word with each bit corresponding to a function. Whenever a bit is set to 1, the corresponding function is in use.</p> <p>The bits of the binary number correspond to the following functions:</p>													
<table border="1"> <thead> <tr> <th>Bit</th> <th>Function</th> </tr> </thead> <tbody> <tr> <td>0</td> <td>Timer1 ena (Time period 1 enable)</td> </tr> <tr> <td>1</td> <td>Timer2 ena (Time period 2 enable)</td> </tr> <tr> <td>2</td> <td>Timer3 ena (Time period 3 enable)</td> </tr> <tr> <td>3</td> <td>Timer4 ena (Time period 4 enable)</td> </tr> <tr> <td>4</td> <td>Boost ena (Boost enable)</td> </tr> </tbody> </table>				Bit	Function	0	Timer1 ena (Time period 1 enable)	1	Timer2 ena (Time period 2 enable)	2	Timer3 ena (Time period 3 enable)	3	Timer4 ena (Time period 4 enable)	4	Boost ena (Boost enable)
Bit	Function														
0	Timer1 ena (Time period 1 enable)														
1	Timer2 ena (Time period 2 enable)														
2	Timer3 ena (Time period 3 enable)														
3	Timer4 ena (Time period 4 enable)														
4	Boost ena (Boost enable)														
36.22	Timed func2	<p>Selects which time periods (1...4) are used with timed function 2. Also determines whether boost is used with timed function 2.</p> <p>The parameter is a 16-bit word with each bit corresponding to a function. Whenever a bit is set to 1, the corresponding function is in use.</p> <p>The bits of the binary number correspond to the following functions:</p>													
<table border="1"> <thead> <tr> <th>Bit</th> <th>Function</th> </tr> </thead> <tbody> <tr> <td>0</td> <td>Timer1 ena (Time period 1 enable)</td> </tr> <tr> <td>1</td> <td>Timer2 ena (Time period 2 enable)</td> </tr> <tr> <td>2</td> <td>Timer3 ena (Time period 3 enable)</td> </tr> <tr> <td>3</td> <td>Timer4 ena (Time period 4 enable)</td> </tr> <tr> <td>4</td> <td>Boost ena (Boost enable)</td> </tr> </tbody> </table>				Bit	Function	0	Timer1 ena (Time period 1 enable)	1	Timer2 ena (Time period 2 enable)	2	Timer3 ena (Time period 3 enable)	3	Timer4 ena (Time period 4 enable)	4	Boost ena (Boost enable)
Bit	Function														
0	Timer1 ena (Time period 1 enable)														
1	Timer2 ena (Time period 2 enable)														
2	Timer3 ena (Time period 3 enable)														
3	Timer4 ena (Time period 4 enable)														
4	Boost ena (Boost enable)														

No.	Name/Value	Description	FbEq												
36.23	Timed func3	<p>Selects which time periods (1...4) are used with timed function 3. Also determines whether boost is used with timed function 3.</p> <p>The parameter is a 16-bit word with each bit corresponding to a function. Whenever a bit is set to 1, the corresponding function is in use.</p> <p>The bits of the binary number correspond to the following functions:</p>													
<table border="1"> <thead> <tr> <th>Bit</th> <th>Function</th> </tr> </thead> <tbody> <tr> <td>0</td> <td>Timer1 ena (Time period 1 enable)</td> </tr> <tr> <td>1</td> <td>Timer2 ena (Time period 2 enable)</td> </tr> <tr> <td>2</td> <td>Timer3 ena (Time period 3 enable)</td> </tr> <tr> <td>3</td> <td>Timer4 ena (Time period 4 enable)</td> </tr> <tr> <td>4</td> <td>Boost ena (Boost enable)</td> </tr> </tbody> </table>				Bit	Function	0	Timer1 ena (Time period 1 enable)	1	Timer2 ena (Time period 2 enable)	2	Timer3 ena (Time period 3 enable)	3	Timer4 ena (Time period 4 enable)	4	Boost ena (Boost enable)
Bit	Function														
0	Timer1 ena (Time period 1 enable)														
1	Timer2 ena (Time period 2 enable)														
2	Timer3 ena (Time period 3 enable)														
3	Timer4 ena (Time period 4 enable)														
4	Boost ena (Boost enable)														
36.24	Timed func4	<p>Selects which time periods (1...4) are used with timed function 4. Also determines whether boost is used with timed function 4.</p> <p>The parameter is a 16-bit word with each bit corresponding to a function. Whenever a bit is set to 1, the corresponding function is in use.</p> <p>The bits of the binary number correspond to the following functions:</p>													
<table border="1"> <thead> <tr> <th>Bit</th> <th>Function</th> </tr> </thead> <tbody> <tr> <td>0</td> <td>Timer1 ena (Time period 1 enable)</td> </tr> <tr> <td>1</td> <td>Timer2 ena (Time period 2 enable)</td> </tr> <tr> <td>2</td> <td>Timer3 ena (Time period 3 enable)</td> </tr> <tr> <td>3</td> <td>Timer4 ena (Time period 4 enable)</td> </tr> <tr> <td>4</td> <td>Boost ena (Boost enable)</td> </tr> </tbody> </table>				Bit	Function	0	Timer1 ena (Time period 1 enable)	1	Timer2 ena (Time period 2 enable)	2	Timer3 ena (Time period 3 enable)	3	Timer4 ena (Time period 4 enable)	4	Boost ena (Boost enable)
Bit	Function														
0	Timer1 ena (Time period 1 enable)														
1	Timer2 ena (Time period 2 enable)														
2	Timer3 ena (Time period 3 enable)														
3	Timer4 ena (Time period 4 enable)														
4	Boost ena (Boost enable)														

38 Flux ref	Flux reference and <i>U/f</i> curve settings. See also section User-definable U/f curve on page 79.		
38.01	Flux ref	Sets the flux reference (in percent of parameter 99.08 Mot nom freq) at field weakening point.	
	0 ... 200%	Flux reference at field weakening point.	1 = 1%
38.03	<i>U/f</i> curve func	Selects the form of the <i>U/f</i> (voltage/frequency) curve below the field weakening point.	
	Linear	Linear <i>U/f</i> curve. Recommended for constant-torque applications.	0
	Quadratic	Quadratic <i>U/f</i> curve. Recommended for centrifugal pump and fan applications.	1
	User	Custom <i>U/f</i> curve. The curve is formed by the points defined by parameters 38.04 ... 38.13 .	2
38.04	<i>U/f</i> curve freq1	Defines the frequency at the 1st point on the custom <i>U/f</i> curve in percent of parameter 99.08 Mot nom freq .	
	1 ... 500%	1st point, frequency.	1 = 1%
38.05	<i>U/f</i> curve freq2	Defines the frequency at the 2nd point on the custom <i>U/f</i> curve in percent of parameter 99.08 Mot nom freq .	
	1 ... 500%	2nd point, frequency.	1 = 1%

200 Parameters

No.	Name/Value	Description	FbEq
38.06	U/f curve freq3	Defines the frequency at the 3rd point on the custom U/f curve in percent of parameter 99.08 Mot nom freq.	
	1 ... 500%	3rd point, frequency.	1 = 1%
38.07	U/f curve freq4	Defines the frequency at the 4th point on the custom U/f curve in percent of parameter 99.08 Mot nom freq.	
	1 ... 500%	4th point, frequency.	1 = 1%
38.08	U/f curve freq5	Defines the frequency at the 5th point on the custom U/f curve in percent of parameter 99.08 Mot nom freq.	
	1 ... 500%	5th point, frequency.	1 = 1%
38.09	U/f curve volt1	Defines the voltage at the 1st point on the custom U/f curve in percent of parameter 99.07 Mot nom voltage.	
	0 ... 200%	1st point, voltage.	1 = 1%
38.10	U/f curve volt2	Defines the voltage at the 2nd point on the custom U/f curve in percent of parameter 99.07 Mot nom voltage.	
	0 ... 200%	2nd point, voltage.	1 = 1%
38.11	U/f curve volt3	Defines the voltage at the 3rd point on the custom U/f curve in percent of parameter 99.07 Mot nom voltage.	
	0 ... 200%	3rd point, voltage.	1 = 1%
38.12	U/f curve volt4	Defines the voltage at the 4th point on the custom U/f curve in percent of parameter 99.07 Mot nom voltage.	
	0 ... 200%	4th point, voltage.	1 = 1%
38.13	U/f curve volt5	Defines the voltage at the 5th point on the custom U/f curve in percent of parameter 99.07 Mot nom voltage.	
	0 ... 200%	5th point, voltage.	1 = 1%
40 Motor control		Motor control settings.	
40.01	Motor noise	An optimization setting for balancing between control performance and motor noise level.	
	Cyclic	Maximizes inverter overloadability.	0
	Low noise	Minimizes motor noise.	1
	Default	Control performance optimized for long motor cables.	2
40.03	Slip gain	Defines the slip gain which is used to improve the estimated motor slip. 100% means full slip gain; 0% means no slip gain. The default value is 100%. Other values can be used if a static speed error is detected despite of the full slip gain. Example (with nominal load and nominal slip of 40 rpm): A 1000 rpm constant speed reference is given to the drive. Despite of the full slip gain (= 100%), a manual tachometer measurement from the motor axis gives a speed value of 998 rpm. The static speed error is 1000 rpm - 998 rpm = 2 rpm. To compensate the error, the slip gain should be increased. At the 105% gain value, no static speed error exists (2 rpm / 40 rpm = 5%).	
	0 ... 200%	Slip gain.	1 = 1%

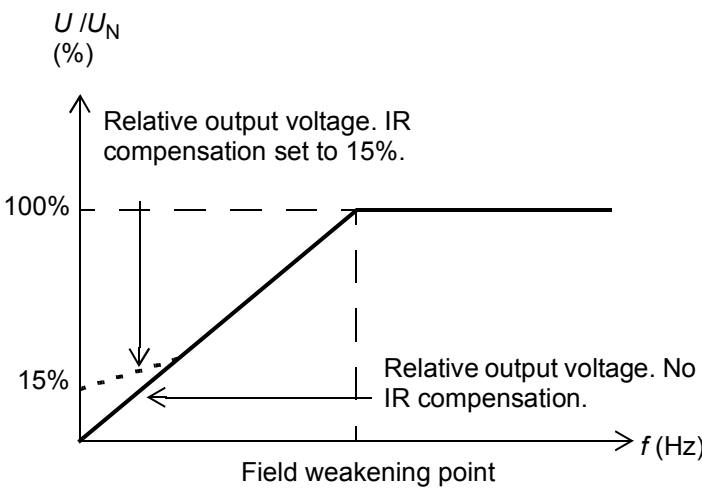
No.	Name/Value	Description	FbEq
40.04	Voltage reserve	Defines the minimum allowed voltage reserve. When the voltage reserve has decreased to the set value, the drive enters the field weakening area. If the intermediate circuit DC voltage $U_{dc} = 550 \text{ V}$ and the voltage reserve is 5%, the RMS value of the maximum output voltage in steady-state operation is $0.95 \times 550 \text{ V} / \sqrt{2} = 369 \text{ V}$ The dynamic performance of the motor control in the field weakening area can be improved by increasing the voltage reserve value, but the drive enters the field weakening area earlier.	
	-4 ... 50%	Voltage reserve.	1 = 1%
40.06	Force open loop	Defines the speed/position information used by the motor model.	
	False	Motor model uses the speed feedback selected by parameter 19.02 Speed fb sel .	0
	True	Motor model uses the internal speed estimate (even when parameter 19.02 Speed fb sel is set to Enc1 speed / Enc2 speed).	1
40.07	IR-compensation	Defines the relative output voltage boost at zero speed (IR compensation). The function is useful in applications with a high break-away torque where direct torque control (DTC mode) cannot be applied.  See also section IR compensation for a scalar controlled drive on page 74.	
	0.00 ... 50.00%	Voltage boost at zero speed in percent of nominal motor voltage.	100 = 1%
42 Mech brake ctrl		Mechanical brake control configuration. See also section Mechanical brake control on page 66.	
42.01	Brake ctrl	Activates the brake control function with or without supervision. Note: This parameter cannot be changed while the drive is running.	
	No	Brake control disabled.	0
	With ack	Brake control enabled with supervision (supervision is activated by parameter 42.02 Brake acknowl).	1

202 Parameters

No.	Name/Value	Description	FbEq
	No ack	Brake control enabled without supervision.	2
42.02	Brake acknowl	<p>Selects the source for the external brake on/off supervision activation (when parameter 42.01 Brake ctrl is set to <i>With ack</i>). The use of the external on/off supervision signal is optional.</p> <p>1 = The brake is open 0 = The brake is closed</p> <p>Brake supervision is usually controlled with a digital input. It can also be controlled with an external control system, e.g. fieldbus.</p> <p>When a brake control error is detected, the drive reacts as defined by parameter 42.12 Brake fault func.</p> <p>Note: This parameter cannot be changed while the drive is running.</p>	
	DI4	Digital input DI4 (as indicated by 02.01 DI status , bit 3).	1073938945
	DI5	Digital input DI5 (as indicated by 02.01 DI status , bit 4).	1074004481
	DI6	Digital input DI6 (as indicated by 02.01 DI status , bit 5).	1074070017
	DIO4	Digital input/output DIO4 (as indicated by 02.03 DIO status , bit 3).	1073938947
	DIO5	Digital input/output DIO5 (as indicated by 02.03 DIO status , bit 4).	1074004483
	DIO6	Digital input/output DIO6 (as indicated by 02.03 DIO status , bit 5).	1074070019
	Const	Bit pointer setting (see Terms and abbreviations on page 93).	-
	Pointer		
42.03	Open delay	<p>Defines the brake open delay (= the delay between the internal open brake command and the release of the motor speed control). The delay counter starts when the drive has magnetised the motor and risen the motor torque to the level required at the brake release (parameter 42.08 Brake open torq). Simultaneously with the counter start, the brake function energises the relay output controlling the brake and the brake starts opening.</p> <p>Set the delay the same as the mechanical opening delay of the brake specified by the brake manufacturer.</p>	
	0.00 ... 5.00 s	Brake open delay.	100 = 1 s
42.04	Close delay	<p>Defines the brake close delay. The delay counter starts when the motor actual speed has fallen below the set level (parameter 42.05 Close speed) after the drive has received the stop command. Simultaneously with the counter start, the brake control function de-energises the relay output controlling the brake and the brake starts closing. During the delay, the brake function keeps the motor live preventing the motor speed from falling below zero.</p> <p>Set the delay time to the same value as the mechanical make-up time of the brake (= operating delay when closing) specified by the brake manufacturer.</p>	
	0.00 ... 60.00 s	Brake close delay.	100 = 1 s
42.05	Close speed	Defines the brake close speed (as an absolute value). See parameter 42.04 Close delay .	
	0.0 ... 1000.0 rpm	Brake close speed.	10 = 1 rpm

No.	Name/Value	Description	FbEq
42.06	Close cmd delay	Defines a close command delay, i.e. the time between when brake close conditions are met and when the close command is given.	
	0.00 ... 10.00 s	Brake close command delay.	100 = 1 s
42.07	Reopen delay	Defines a reopen delay, i.e. the time between when the close command is given and when the brake can be reopened.	
	0.00 ... 10.00 s	Brake reopen delay.	100 = 1 s
42.08	Brake open torq	Defines the motor starting torque at brake release (in percent of the motor nominal torque) when parameter 42.09 Open torq src is set to P.42.08 .	
	-1000.0 ... 1000.0%	Motor starting torque at brake release.	10 = 1%
42.09	Open torq src	Selects the source for the “brake open” torque value (motor starting torque at brake release).	
	Zero	Zero speed reference.	0
	AI1 scaled	02.05 AI1 scaled (see page 95).	1073742341
	AI2 scaled	02.07 AI2 scaled (see page 95).	1073742343
	FBA ref1	02.26 FBA main ref1 (see page 100).	1073742362
	FBA ref2	02.27 FBA main ref2 (see page 100).	1073742363
	D2D ref1	02.32 D2D ref1 (see page 101).	1073742368
	D2D ref2	02.33 D2D ref2 (see page 101).	1073742369
	Brk torq mem	03.15 Brake torq mem (see page 101).	1073742607
	P.42.08	Parameter 42.08 Brake open torq .	1073752584
	Pointer	Value pointer setting (see Terms and abbreviations on page 93).	-
42.10	Brake close req	Selects the source for the brake close/open request. 1 = Brake close request 0 = Brake open request Note: This parameter cannot be changed while the drive is running.	
	DI4	Digital input DI4 (as indicated by 02.01 DI status , bit 3).	1073938945
	DI5	Digital input DI5 (as indicated by 02.01 DI status , bit 4).	1074004481
	DI6	Digital input DI6 (as indicated by 02.01 DI status , bit 5).	1074070017
	DIO4	Digital input/output DIO4 (as indicated by 02.03 DIO status , bit 3).	1073938947
	DIO5	Digital input/output DIO5 (as indicated by 02.03 DIO status , bit 4).	1074004483
	DIO6	Digital input/output DIO6 (as indicated by 02.03 DIO status , bit 5).	1074070019
	Const	Bit pointer setting (see Terms and abbreviations on page 93).	-
	Pointer		
42.11	Brake hold open	Selects the source for the activation of the brake open command hold. 1 = Hold active 0 = Normal operation Note: This parameter cannot be changed while the drive is running.	
	DI4	Digital input DI4 (as indicated by 02.01 DI status , bit 3).	1073938945

No.	Name/Value	Description	FbEq
	DI5	Digital input DI5 (as indicated by 02.01 DI status , bit 4).	1074004481
	DI6	Digital input DI6 (as indicated by 02.01 DI status , bit 5).	1074070017
	DIO4	Digital input/output DIO4 (as indicated by 02.03 DIO status , bit 3).	1073938947
	DIO5	Digital input/output DIO5 (as indicated by 02.03 DIO status , bit 4).	1074004483
	DIO6	Digital input/output DIO6 (as indicated by 02.03 DIO status , bit 5).	1074070019
	Const	Bit pointer setting (see Terms and abbreviations on page 93).	-
	Pointer		
42.12	Brake fault func	Defines how the drive reacts in case of mechanical brake control error. If brake control supervision has not been activated by parameter 42.01 Brake ctrl , this parameter is disabled.	
	Fault	The drive trips on fault BRAKE NOT CLOSED / BRAKE NOT OPEN if the status of the optional external brake acknowledgement signal does not meet the status presumed by the brake control function. The drive trips on fault BRAKE START TORQUE if the required motor starting torque at brake release is not achieved.	0
	Alarm	The drive generates alarm BRAKE NOT CLOSED / BRAKE NOT OPEN if the status of the optional external brake acknowledgement signal does not meet the status presumed by the brake control function. The drive generates alarm BRAKE START TORQUE if the required motor starting torque at brake release is not achieved.	1
	Open flt	The drive trips on fault BRAKE NOT CLOSED / BRAKE NOT OPEN if the status of the optional external brake acknowledgement signal does not meet the status presumed by the brake control function during the opening of the brake. Other brake function errors generate alarm BRAKE NOT CLOSED / BRAKE NOT OPEN.	2
42.13	Close flt delay	Defines a close fault delay, i.e. the time between when the brake is closed and when a brake close fault is generated.	
	0.00 ... 60.00 s	Brake close fault delay.	100 = 1 s

No.	Name/Value	Description	FbEq						
44 Maintenance		Maintenance counter configuration. See also section Maintenance counters on page 65.							
44.01	Ontime1 func	Configures on-time counter 1. This counter runs whenever the signal selected by parameter 44.02 Ontime1 src is on. After the limit set by parameter 44.03 Ontime1 limit is reached, an alarm specified by parameter 44.04 Ontime1 alm sel is given, and the counter reset. The current value of the counter is readable from parameter 04.09 Counter ontime1 . Bit 0 of 06.15 Counter status indicates that the count has exceeded the limit.							
		<table border="1"> <thead> <tr> <th>Bit</th> <th>Function</th> </tr> </thead> <tbody> <tr> <td>0</td> <td>Counter mode 0 = Loop: If alarm is enabled by bit 1, the alarm stays active only for 10 seconds. 1 = Saturate: If alarm is enabled by bit 1, the alarm stays active until reset.</td> </tr> <tr> <td>1</td> <td>Alarm ena (Alarm enable) 0 = Disable: No alarm is given when limit is reached. 1 = Enable: Alarm is given when limit is reached.</td> </tr> </tbody> </table>	Bit	Function	0	Counter mode 0 = Loop: If alarm is enabled by bit 1, the alarm stays active only for 10 seconds. 1 = Saturate: If alarm is enabled by bit 1, the alarm stays active until reset.	1	Alarm ena (Alarm enable) 0 = Disable: No alarm is given when limit is reached. 1 = Enable: Alarm is given when limit is reached.	
Bit	Function								
0	Counter mode 0 = Loop: If alarm is enabled by bit 1, the alarm stays active only for 10 seconds. 1 = Saturate: If alarm is enabled by bit 1, the alarm stays active until reset.								
1	Alarm ena (Alarm enable) 0 = Disable: No alarm is given when limit is reached. 1 = Enable: Alarm is given when limit is reached.								
44.02	Ontime1 src	Selects the signal to be monitored by on-time counter 1. See parameter 44.01 Ontime1 func .							
	RO1	Relay output RO1 (as indicated by 02.02 RO status , bit 0).	1073742338						
	Running	Bit 3 of 06.01 Status word1 (see page 103).	1073939969						
	Charged	Bit 9 of 06.02 Status word2 (see page 104).	1074333186						
	Const	Bit pointer setting (see Terms and abbreviations on page 93).	-						
	Pointer								
44.03	Ontime1 limit	Sets the alarm limit for on-time counter 1. See parameter 44.01 Ontime1 func .							
	0...2147483647 s	Alarm limit for on-time counter 1.							
44.04	Ontime1 alm sel	Selects the alarm for on-time counter 1. See parameter 44.01 Ontime1 func .							
	On-time1	Pre-selectable alarm for on-time counter 1.	0						
	Device clean	Pre-selectable alarm for on-time counter 1.	1						
	Add cool fan	Pre-selectable alarm for on-time counter 1.	2						
	Cabinet fan	Pre-selectable alarm for on-time counter 1.	3						
	Dc-capacitor	Pre-selectable alarm for on-time counter 1.	4						
	Mot bearing	Pre-selectable alarm for on-time counter 1.	5						

No.	Name/Value	Description	FbEq						
44.05	Ontime2 func	<p>Configures on-time counter 2. This counter runs whenever the signal selected by parameter 44.06 Ontime2 src is on. After the limit set by parameter 44.07 Ontime2 limit is reached, an alarm specified by parameter 44.08 Ontime2 alm sel is given, and the counter reset.</p> <p>The current value of the counter is readable from parameter 04.10 Counter ontime2. Bit 1 of 06.15 Counter status indicates that the count has exceeded the limit.</p>							
		<table border="1"> <thead> <tr> <th>Bit</th> <th>Function</th> </tr> </thead> <tbody> <tr> <td>0</td> <td> Counter mode 0 = Loop: If alarm is enabled by bit 1, the alarm stays active only for 10 seconds. 1 = Saturate: If alarm is enabled by bit 1, the alarm stays active until reset. </td> </tr> <tr> <td>1</td> <td> Alarm ena (Alarm enable) 0 = Disable: No alarm is given when limit is reached. 1 = Enable: Alarm is given when limit is reached. </td> </tr> </tbody> </table>	Bit	Function	0	Counter mode 0 = Loop: If alarm is enabled by bit 1, the alarm stays active only for 10 seconds. 1 = Saturate: If alarm is enabled by bit 1, the alarm stays active until reset.	1	Alarm ena (Alarm enable) 0 = Disable: No alarm is given when limit is reached. 1 = Enable: Alarm is given when limit is reached.	
Bit	Function								
0	Counter mode 0 = Loop: If alarm is enabled by bit 1, the alarm stays active only for 10 seconds. 1 = Saturate: If alarm is enabled by bit 1, the alarm stays active until reset.								
1	Alarm ena (Alarm enable) 0 = Disable: No alarm is given when limit is reached. 1 = Enable: Alarm is given when limit is reached.								
44.06	Ontime2 src	Selects the signal to be monitored by on-time counter 2. See parameter 44.05 Ontime2 func .							
	RO1	Relay output RO1 (as indicated by 02.02 RO status , bit 0).	1073742338						
	Running	Bit 3 of 06.01 Status word1 (see page 103).	1073939969						
	Charged	Bit 9 of 06.02 Status word2 (see page 104).	1074333186						
	Const	Bit pointer setting (see Terms and abbreviations on page 93).	-						
	Pointer								
44.07	Ontime2 limit	Sets the alarm limit for on-time counter 2. See parameter 44.05 Ontime2 func .							
	0 ... 2147483647 s	Alarm limit for on-time counter 2.	1 = 1 s						
44.08	Ontime2 alm sel	Selects the alarm for on-time counter 2. See parameter 44.05 Ontime2 func .							
	On-time2	Pre-selectable alarm for on-time counter 2.	0						
	Device clean	Pre-selectable alarm for on-time counter 2.	1						
	Add cool fan	Pre-selectable alarm for on-time counter 2.	2						
	Cabinet fan	Pre-selectable alarm for on-time counter 2.	3						
	Dc-capacitor	Pre-selectable alarm for on-time counter 2.	4						
	Mot bearing	Pre-selectable alarm for on-time counter 2.	5						

No.	Name/Value	Description	FbEq						
44.09	Edge count1 func	<p>Configures rising edge counter 1. This counter is incremented every time the signal selected by parameter 44.10 Edge count1 src switches on (unless a divisor value is applied – see parameter 44.12 Edge count1 div). After the limit set by parameter 44.11 Edge count1 lim is reached, an alarm specified by parameter 44.13 Edg cnt1 alm sel is given, and the counter reset.</p> <p>The current value of the counter is readable from parameter 04.11 Counter edge1. Bit 2 of 06.15 Counter status indicates that the count has exceeded the limit.</p>							
<table border="1"> <thead> <tr> <th>Bit</th> <th>Function</th> </tr> </thead> <tbody> <tr> <td>0</td> <td> Counter mode 0 = Loop: If alarm is enabled by bit 1, the alarm stays active only for 10 seconds. 1 = Saturate: If alarm is enabled by bit 1, the alarm stays active until reset. </td> </tr> <tr> <td>1</td> <td> Alarm ena (Alarm enable) 0 = Disable: No alarm is given when limit is reached. 1 = Enable: Alarm is given when limit is reached. </td> </tr> </tbody> </table>				Bit	Function	0	Counter mode 0 = Loop: If alarm is enabled by bit 1, the alarm stays active only for 10 seconds. 1 = Saturate: If alarm is enabled by bit 1, the alarm stays active until reset.	1	Alarm ena (Alarm enable) 0 = Disable: No alarm is given when limit is reached. 1 = Enable: Alarm is given when limit is reached.
Bit	Function								
0	Counter mode 0 = Loop: If alarm is enabled by bit 1, the alarm stays active only for 10 seconds. 1 = Saturate: If alarm is enabled by bit 1, the alarm stays active until reset.								
1	Alarm ena (Alarm enable) 0 = Disable: No alarm is given when limit is reached. 1 = Enable: Alarm is given when limit is reached.								
44.10	Edge count1 src	Selects the signal to be monitored by rising edge counter 1. See parameter 44.09 Edge count1 func .							
	RO1	Relay output RO1 (as indicated by 02.02 RO status , bit 0).	1073742338						
	Running	Bit 3 of 06.01 Status word1 (see page 103).	1073939969						
	Charged	Bit 9 of 06.02 Status word2 (see page 104).	1074333186						
	Const	Bit pointer setting (see Terms and abbreviations on page 93).	-						
	Pointer								
44.11	Edge count1 lim	Sets the alarm limit for rising edge counter 1. See parameter 44.09 Edge count1 func .							
	0 ... 2147483647	Alarm limit for rising edge counter 1.	1 = 1						
44.12	Edge count1 div	Divisor for rising edge counter 1. Determines how many rising edges increment the counter by 1.							
	1 ... 2147483647	Divisor for rising edge counter 1.	1 = 1						
44.13	Edg cnt1 alm sel	Selects the alarm for rising edge counter 1. See parameter 44.09 Edge count1 func .							
	Edge count1	Pre-selectable alarm for rising edge counter 1.	0						
	Main cntactr	Pre-selectable alarm for rising edge counter 1.	1						
	Output relay	Pre-selectable alarm for rising edge counter 1.	2						
	Motor starts	Pre-selectable alarm for rising edge counter 1.	3						
	Power ups	Pre-selectable alarm for rising edge counter 1.	4						
	Dc-charge	Pre-selectable alarm for rising edge counter 1.	5						

No.	Name/Value	Description	FbEq						
44.14	Edge count2 func	<p>Configures rising edge counter 2. The counter is incremented every time the signal selected by parameter 44.15 Edge count2 src switches on (unless a divisor value is applied – see parameter 44.17 Edge count2 div). After the limit set by parameter 44.16 Edge count2 lim is reached, an alarm specified by parameter 44.22 Edg cnt2 alm sel is given and the counter is reset.</p> <p>The current value of the counter is readable from parameter 04.12 Counter edge2. Bit 3 of 06.15 Counter status indicates that the count has exceeded the limit.</p>							
<table border="1"> <thead> <tr> <th>Bit</th> <th>Function</th> </tr> </thead> <tbody> <tr> <td>0</td> <td> Counter mode 0 = Loop: If alarm is enabled by bit 1, the alarm stays active only for 10 seconds. 1 = Saturate: If alarm is enabled by bit 1, the alarm stays active until reset. </td> </tr> <tr> <td>1</td> <td> Alarm ena (Alarm enable) 0 = Disable: No alarm is given when limit is reached. 1 = Enable: Alarm is given when limit is reached. </td> </tr> </tbody> </table>				Bit	Function	0	Counter mode 0 = Loop: If alarm is enabled by bit 1, the alarm stays active only for 10 seconds. 1 = Saturate: If alarm is enabled by bit 1, the alarm stays active until reset.	1	Alarm ena (Alarm enable) 0 = Disable: No alarm is given when limit is reached. 1 = Enable: Alarm is given when limit is reached.
Bit	Function								
0	Counter mode 0 = Loop: If alarm is enabled by bit 1, the alarm stays active only for 10 seconds. 1 = Saturate: If alarm is enabled by bit 1, the alarm stays active until reset.								
1	Alarm ena (Alarm enable) 0 = Disable: No alarm is given when limit is reached. 1 = Enable: Alarm is given when limit is reached.								
44.15	Edge count2 src	Selects the signal to be monitored by rising edge counter 2. See parameter 44.14 Edge count2 func .							
	RO1	Relay output RO1 (as indicated by 02.02 RO status , bit 0).	1073742338						
	Running	Bit 3 of 06.01 Status word1 (see page 103).	1073939969						
	Charged	Bit 9 of 06.02 Status word2 (see page 104).	1074333186						
	Const	Bit pointer setting (see Terms and abbreviations on page 93).	-						
	Pointer								
44.16	Edge count2 lim	Sets the alarm limit for rising edge counter 2. See parameter 44.14 Edge count2 func .							
	0 ... 2147483647	Alarm limit for rising edge counter 2.	1 = 1						
44.17	Edge count2 div	Divisor for rising edge counter 2. Determines how many rising edges increment the counter by 1.							
	1 ... 2147483647	Divisor for rising edge counter 2.	1 = 1						
44.18	Edg cnt2 alm sel	Selects the alarm for rising edge counter 2. See parameter 44.14 Edge count2 func .							
	Edge count2	Pre-selectable alarm for rising edge counter 2.	0						
	Main cntactr	Pre-selectable alarm for rising edge counter 2.	1						
	Output relay	Pre-selectable alarm for rising edge counter 2.	2						
	Motor starts	Pre-selectable alarm for rising edge counter 2.	3						
	Power ups	Pre-selectable alarm for rising edge counter 2.	4						
	Dc-charge	Pre-selectable alarm for rising edge counter 2.	5						

No.	Name/Value	Description	FbEq						
44.19	Val count1 func	<p>Configures value counter 1. This counter measures, by integration, the area below the signal selected by parameter 44.20 Val count1 src. When the total area exceeds the limit set by parameter 44.21 Val count1 lim, an alarm is given (if enabled by bit 1 of this parameter).</p> <p>The signal is sampled at 1-second intervals. Note that the scaled (see the “FbEq” column at the signal in question) value of the signal is used.</p> <p>The current value of the counter is readable from parameter 04.13 Counter value1. Bit 4 of 06.15 Counter status indicates that the counter has exceeded the limit.</p>							
		<table border="1"> <thead> <tr> <th>Bit</th> <th>Function</th> </tr> </thead> <tbody> <tr> <td>0</td> <td> Counter mode 0 = Loop: If alarm is enabled by bit 1, the alarm stays active only for 10 seconds. 1 = Saturate: If alarm is enabled by bit 1, the alarm stays active until reset. </td> </tr> <tr> <td>1</td> <td> Alarm ena (Alarm enable) 0 = Disable: No alarm is given when limit is reached. 1 = Enable: Alarm is given when limit is reached. </td> </tr> </tbody> </table>	Bit	Function	0	Counter mode 0 = Loop: If alarm is enabled by bit 1, the alarm stays active only for 10 seconds. 1 = Saturate: If alarm is enabled by bit 1, the alarm stays active until reset.	1	Alarm ena (Alarm enable) 0 = Disable: No alarm is given when limit is reached. 1 = Enable: Alarm is given when limit is reached.	
Bit	Function								
0	Counter mode 0 = Loop: If alarm is enabled by bit 1, the alarm stays active only for 10 seconds. 1 = Saturate: If alarm is enabled by bit 1, the alarm stays active until reset.								
1	Alarm ena (Alarm enable) 0 = Disable: No alarm is given when limit is reached. 1 = Enable: Alarm is given when limit is reached.								
44.20	Val count1 src	Selects the signal to be monitored by value counter 1. See parameter 44.19 Val count1 func .							
	Speed rpm	01.01 Motor speed rpm (see page 94).	1073742081						
	Pointer	Value pointer setting (see Terms and abbreviations on page 93).	-						
44.21	Val count1 lim	Sets the alarm limit for value counter 1. See parameter 44.19 Val count1 func .							
	0 ... 2147483647	Alarm limit for value counter 1.	1 = 1						
44.22	Val count1 div	Divisor for value counter 1. The value of the monitored signal is divided by this value before integration.							
	1 ... 2147483647	Divisor for value counter 1.	1 = 1						
44.23	Val cnt1 alm sel	Selects the alarm for value counter 1. See parameter 44.19 Val count1 func .							
	Value1	Pre-selectable alarm for value counter 1.	0						
	Mot bearing	Pre-selectable alarm for value counter 1.	1						



210 Parameters

No.	Name/Value	Description	FbEq						
44.24	Val count2 func	<p>Configures value counter 2. This counter measures, by integration, the area below the signal selected by parameter 44.25 Val count2 src. When the total area exceeds the limit set by parameter 44.26 Val count2 lim, an alarm is given (if enabled by bit 1 of this parameter).</p> <p>The signal is sampled at 1-second intervals. Note that the scaled (see the “FbEq” column at the signal in question) value of the signal is used.</p> <p>The current value of the counter is readable from parameter 04.14 Counter value2. Bit 5 of 06.15 Counter status indicates that the counter has exceeded the limit.</p>							
		<table border="1"> <thead> <tr> <th>Bit</th> <th>Function</th> </tr> </thead> <tbody> <tr> <td>0</td> <td> Counter mode 0 = Loop: If alarm is enabled by bit 1, the alarm stays active only for 10 seconds. 1 = Saturate: If alarm is enabled by bit 1, the alarm stays active until reset. </td> </tr> <tr> <td>1</td> <td> Alarm ena (Alarm enable) 0 = Disable: No alarm is given when limit is reached. 1 = Enable: Alarm is given when limit is reached. </td> </tr> </tbody> </table>	Bit	Function	0	Counter mode 0 = Loop: If alarm is enabled by bit 1, the alarm stays active only for 10 seconds. 1 = Saturate: If alarm is enabled by bit 1, the alarm stays active until reset.	1	Alarm ena (Alarm enable) 0 = Disable: No alarm is given when limit is reached. 1 = Enable: Alarm is given when limit is reached.	
Bit	Function								
0	Counter mode 0 = Loop: If alarm is enabled by bit 1, the alarm stays active only for 10 seconds. 1 = Saturate: If alarm is enabled by bit 1, the alarm stays active until reset.								
1	Alarm ena (Alarm enable) 0 = Disable: No alarm is given when limit is reached. 1 = Enable: Alarm is given when limit is reached.								
44.25	Val count2 src	Selects the signal to be monitored by value counter 2. See parameter 44.24 Val count2 func .							
	Speed rpm	01.01 Motor speed rpm (see page 94).	1073742081						
	Pointer	Value pointer setting (see Terms and abbreviations on page 93).	-						
44.26	Val count2 lim	Sets the alarm limit for value counter 2. See parameter 44.24 Val count2 func .							
	0 ... 2147483647	Alarm limit for value counter 2.	1 = 1						
44.27	Val count2 div	Divisor for value counter 2. The value of the monitored signal is divided by this value before integration.							
	1 ... 2147483647	Divisor for value counter 2.	1 = 1						
44.28	Val cnt2 alm sel	Selects the alarm for value counter 2. See parameter 44.24 Val count2 func .							
	Value2	Pre-selectable alarm for value counter 2.	0						
	Mot bearing	Pre-selectable alarm for value counter 2.	1						
44.29	Fan ontime lim	Sets the limit for the cooling fan on-time counter. The counter monitors signal 01.28 Fan on-time (see page 95). When the signal reaches the limit, alarm 2056 COOLING FAN (0x5081) is given.							
	0.00 ... 35791394.11 h	Alarm limit for cooling fan on-time.	1 = 1 min						
44.30	Runtime lim	Sets the limit for the drive run-time counter. The counter monitors signal 01.27 Run-time counter (see page 95). When the signal reaches the limit, the alarm specified by parameter 44.31 Runtime alm sel is given.							
	0.00 ... 35791394.11 h	Alarm limit for the drive run-time counter.	1 = 1 min						
44.31	Runtime alm sel	Selects the alarm for the drive run time counter.							
	Device clean	Pre-selectable alarm for the drive run time counter.	1						
	Add cool fan	Pre-selectable alarm for the drive run time counter.	2						
	Cabinet fan	Pre-selectable alarm for the drive run time counter.	3						

No.	Name/Value	Description	FbEq
	Dc-capacitor	Pre-selectable alarm for the drive run time counter.	4
	Mot bearing	Pre-selectable alarm for the drive run time counter.	5
44.32	kWh inv lim	Sets the limit for the energy counter. The counter monitors signal 01.24 kWh inverter (see page 94). When the signal reaches the limit, the alarm specified by parameter 44.33 kWh inv alm sel is given.	
	0 ... 2147483647	Alarm limit for the energy counter.	1 = 1 kWh
44.33	kWh inv alm sel	Selects the alarm for the energy counter.	
	Device clean	Pre-selectable alarm for the energy counter.	1
	Add cool fan	Pre-selectable alarm for the energy counter.	2
	Cabinet fan	Pre-selectable alarm for the energy counter.	3
	Dc-capacitor	Pre-selectable alarm for the energy counter.	4
	Mot bearing	Pre-selectable alarm for the energy counter.	5
45 Energy optimising		Energy optimization settings. See also section Energy optimizer on page 62.	
45.01	Energy optim	Enables/disables energy optimization function. The function optimizes the flux so that total energy consumption and motor noise level are reduced when the drive operates below the nominal load. The total efficiency (motor and drive) can be improved by 1...10% depending on load torque and speed.	
	Disable	Energy optimization disabled.	0
	Enable	Energy optimization enabled.	1
45.02	Energy tariff1	Price of energy per kWh. Used for reference when savings are calculated. See parameters 01.35 Saved energy , 01.36 Saved amount and 01.37 Saved CO2 .	
	0.00 ... 21474836.47	Price of energy per kWh.	1 = 1
45.06	E tariff unit	Specifies the currency used for the savings calculation.	
	Local	The currency is determined by the setting of parameter 99.01 Language .	0
	Eur	Euro.	1
	Usd	US dollar.	2
45.08	Pump ref power	Motor power when connected directly to supply. Used for reference when energy savings are calculated. See parameters 01.35 Saved energy , 01.36 Saved amount and 01.37 Saved CO2 . Note: The accuracy of the energy savings calculation is directly dependent on the accuracy of this value.	
	00.0... 1000.0%	Motor power in percent of nominal motor power.	1 = 1
45.09	Energy reset	Resets the energy counters 01.35 Saved energy , 01.36 Saved amount and 01.37 Saved CO2 .	
	Done	Reset not requested (normal operation).	0
	Reset	Reset energy counters. The value reverts automatically to Done .	1

No.	Name/Value	Description	FbEq
47 Voltage ctrl		Overvoltage and undervoltage control settings. See also section DC voltage control on page 59.	
47.01	Overvolt ctrl	Enables the overvoltage control of the intermediate DC link. Fast braking of a high inertia load causes the voltage to rise to the overvoltage control limit. To prevent the DC voltage from exceeding the limit, the overvoltage controller automatically decreases the braking torque. Note: If a brake chopper and resistor or a regenerative supply section are included in the drive, the controller must be disabled.	
	Disable	Overvoltage control disabled.	0
	Enable	Overvoltage control enabled.	1
47.02	Undervolt ctrl	Enables the undervoltage control of the intermediate DC link. If the DC voltage drops due to input power cut off, the undervoltage controller will automatically decrease the motor torque in order to keep the voltage above the lower limit. By decreasing the motor torque, the inertia of the load will cause regeneration back to the drive, keeping the DC link charged and preventing an undervoltage trip until the motor coasts to stop. This will act as a power-loss ride-through functionality in systems with high inertia, such as a centrifuge or a fan.	
	Disable	Undervoltage control disabled.	0
	Enable	Undervoltage control enabled.	1
47.03	SupplyVoltAutold	Enables the auto-identification of the supply voltage.	
	Disable	Auto-identification of supply voltage disabled.	0
	Enable	Auto-identification of supply voltage enabled.	1
47.04	Supply voltage	Defines the nominal supply voltage. Used if auto-identification of the supply voltage is not enabled by parameter 47.03 SupplyVoltAutold .	
	0 ... 1000 V	Nominal supply voltage.	10 = 1 V
48 Brake chopper		Control of the brake chopper.	
48.01	Bc enable	Enables the brake chopper control. Note: Before enabling the brake chopper control, ensure that a brake resistor is connected and the overvoltage control is switched off (parameter 47.01 Overvolt ctrl).	
	Disable	Brake chopper control disabled.	0
	EnableTherm	Brake chopper control enabled with resistor overload protection.	1
	Enable	Brake chopper control enabled without resistor overload protection. This setting can be used, for example, if the resistor is equipped with a thermal circuit breaker that is wired to stop the drive if the resistor overheats.	2

No.	Name/Value	Description	FbEq
48.02	Bc run-time ena	Selects the source for quick run-time brake chopper control. 0 = Brake chopper IGBT pulses are cut off 1 = Normal brake chopper IGBT modulation. The overvoltage control is automatically switched off This parameter can be used to program the chopper control to function only when the drive is operating in the generator mode.	
	Const	Bit pointer setting (see Terms and abbreviations on page 93).	-
	Pointer		
48.03	BrThermTimeConst	Defines the thermal time constant of the brake resistor for overload protection.	
	0 ... 10000 s	Brake resistor thermal time constant.	1 = 1 s
48.04	Br power max cnt	Defines the maximum continuous braking power which will raise the resistor temperature to the maximum allowed value. The value is used in the overload protection.	
	0.0000 ... 10000.0000 kW	Maximum continuous braking power.	10000 = 1 kW
48.05	R br	Defines the resistance value of the brake resistor. The value is used for brake chopper protection.	
	0.1000 ... 1000.0000 ohm	Brake resistor resistance value.	10000 = 1 ohm
48.06	Br temp faultlim	Selects the fault limit for the brake resistor temperature supervision. The value is given in percent of the temperature the resistor reaches when loaded with the power defined by parameter 48.04 Br power max cnt . When the limit is exceeded the drive trips on fault BR OVERHEAT.	
	0 ... 150%	Brake resistor temperature fault limit.	1 = 1%
48.07	Br temp alarmlim	Selects the alarm limit for the brake resistor temperature supervision. The value is given in percent of the temperature the resistor reaches when loaded with the power defined by parameter 48.04 Br power max cnt . When the limit is exceeded, the drive generates a BR OVERHEAT alarm.	
	0 ... 150%	Brake resistor temperature alarm limit.	1 = 1%
49 Data storage		Data storage parameters reserved for the user. These parameters can be written to and read from using other parameters' pointer settings. Four 16-bit and four 32-bit storage parameters are available.	
49.01	Data storage1	Data storage parameter 1.	
	-32768 ... 32767	16-bit data.	1 = 1
49.02	Data storage2	Data storage parameter 2.	
	-32768 ... 32767	16-bit data.	1 = 1
49.03	Data storage3	Data storage parameter 3.	
	-32768 ... 32767	16-bit data.	1 = 1
49.04	Data storage4	Data storage parameter 4.	
	-32768 ... 32767	16-bit data.	1 = 1

No.	Name/Value	Description	FbEq
49.05	Data storage5	Data storage parameter 5.	
	-2147483647 ... 2147483647	32-bit data.	1 = 1
49.06	Data storage6	Data storage parameter 6.	
	-2147483647 ... 2147483647	32-bit data.	1 = 1
49.07	Data storage7	Data storage parameter 7.	
	-2147483647 ... 2147483647	32-bit data.	1 = 1
49.08	Data storage8	Data storage parameter 8.	
	-2147483647 ... 2147483647	32-bit data.	1 = 1
50 Fieldbus		Settings for configuration of communication via a fieldbus adapter.	
50.01	Fba enable	Enables communication between the drive and fieldbus adapter.	
	Disable	Communication between the drive and fieldbus adapter disabled.	0
	Enable	Communication between the drive and fieldbus adapter enabled.	1
50.02	Comm loss func	Selects how the drive reacts in a fieldbus communication break. The time delay is defined by parameter 50.03 Comm loss t out .	
	No	Communication break detection disabled.	0
	Fault	Communication break detection active. Upon a communication break, the drive trips on fault FIELDBUS COMM and coasts to stop.	1
	Spd ref Safe	Communication break detection active. Upon a communication break, the drive generates alarm FIELDBUS COMM and sets the speed to the value defined by parameter 30.02 Speed ref safe .  WARNING! Make sure that it is safe to continue operation in case of a communication break.	2
	Last speed	Communication break detection active. The drive generates alarm FIELDBUS COMM and freezes the speed to the level the drive was operating at. The speed is determined by the average speed over the previous 10 seconds.  WARNING! Make sure that it is safe to continue operation in case of a communication break.	3
50.03	Comm loss t out	Defines the time delay before the action defined by parameter 50.02 Comm loss func is taken. Time count starts when the link fails to update the message.	
	0.3 ... 6553.5 s	Time delay.	10 = 1 s
50.04	Fba ref1 modesel	Selects the fieldbus reference FBA REF1 scaling and the actual value, which is sent to the fieldbus (FBA ACT1).	

No.	Name/Value	Description	FbEq
	Raw data	No scaling (i.e. data is transmitted without scaling). Source for the actual value, which is sent to the fieldbus, is selected by parameter 50.06 Fba act1 tr src .	0
	Torque	Fieldbus adapter module uses torque reference scaling. Torque reference scaling is defined by the used fieldbus profile (e.g. with ABB Drives Profile integer value 10000 corresponds to 100% torque value). Signal 01.06 Motor torque is sent to the fieldbus as an actual value. See the User's Manual of the appropriate fieldbus adapter module.	1
	Speed	Fieldbus adapter module uses speed reference scaling. Speed reference scaling is defined by the used fieldbus profile (e.g. with ABB Drives Profile integer value 20000 corresponds to parameter 19.01 Speed scaling value). Signal 01.01 Motor speed rpm is sent to the fieldbus as an actual value. See the User's Manual of the appropriate fieldbus adapter module.	2
50.05	Fba ref2 modesel	Selects the fieldbus reference FBA REF2 scaling. See parameter 50.04 Fba ref1 modesel .	
	Raw data	See parameter 50.04 Fba ref1 modesel .	0
	Torque	See parameter 50.04 Fba ref1 modesel .	1
	Speed	See parameter 50.04 Fba ref1 modesel .	2
50.06	Fba act1 tr src	Selects the source for fieldbus actual value 1 when parameter 50.04 Fba ref1 modesel / 50.05 Fba ref2 modesel is set to Raw data .	
	Pointer	Value pointer setting (see Terms and abbreviations on page 93).	-
50.07	Fba act2 tr src	Selects the source for fieldbus actual value 2 when parameter 50.04 Fba ref1 modesel / 50.05 Fba ref2 modesel is set to Raw data .	
	Pointer	Value pointer setting (see Terms and abbreviations on page 93).	-
50.08	Fba sw b12 src	Selects the source for freely programmable fieldbus status word bit 28 (02.24 FBA main sw bit 28 SW B28).	
	Const	Bit pointer setting (see Terms and abbreviations on page 93).	-
	Pointer		
50.09	Fba sw b13 src	Selects the source for freely programmable fieldbus status word bit 29 (02.24 FBA main sw bit 29 SW B29).	
	Const	Bit pointer setting (see Terms and abbreviations on page 93).	-
	Pointer		
50.10	Fba sw b14 src	Selects the source for freely programmable fieldbus status word bit 30 (02.24 FBA main sw bit 30 SW B30).	
	Const	Bit pointer setting (see Terms and abbreviations on page 93).	-
	Pointer		
50.11	Fba sw b15 src	Selects the source for freely programmable fieldbus status word bit 31 (02.24 FBA main sw bit 31 SW B31).	
	Const	Bit pointer setting (see Terms and abbreviations on page 93).	-
	Pointer		

No.	Name/Value	Description	FbEq
51 FBA settings		Fieldbus adapter-specific settings.	
51.01	FBA type	Displays the type of the connected fieldbus adapter module. 0 = Fieldbus module is not found, or it is not properly connected, or parameter 50.01 Fba enable is set to <i>Disable</i> , 1 = FPBA-xx PROFIBUS-DP adapter module, 32 = FCAN-xx CANopen adapter module, 37 = FDNA-xx DeviceNet adapter module	
51.02	FBA par2	Parameters 51.02...51.26 are adapter module-specific. For more information, see the User's Manual of the fieldbus adapter module. Note that not all of these parameters are necessarily visible.	-
...
51.26	FBA par26	See parameter 51.02 FBA par2 .	-
51.27	FBA par refresh	Validates any changed adapter module configuration parameter settings. After refreshing, the value reverts automatically to <i>Done</i> . Note: This parameter cannot be changed while the drive is running.	
	Done	Refreshing done.	0
	Refresh	Refreshing.	1
51.28	Par table ver	Displays the parameter table revision of the fieldbus adapter module mapping file stored in the memory of the drive. In format xyz, where x = major revision number; y = minor revision number; z = correction number.	
	0x0000 ... 0xFFFF	Parameter table revision.	1 = 1
51.29	Drive type code	Displays the drive type code of the fieldbus adapter module mapping file stored in the memory of the drive.	
	0 ... 65535	Drive type code of fieldbus adapter module mapping file.	1 = 1
51.30	Mapping file ver	Displays the fieldbus adapter module mapping file revision stored in the memory of the drive in decimal format. Example: 1 = revision 1.	
	0 ... 65535	Mapping file revision.	1 = 1
51.31	D2FBA comm sta	Displays the status of the fieldbus adapter module communication.	
	Idle	Adapter is not configured.	0
	Exec.init	Adapter is initializing.	1
	Time out	A timeout has occurred in the communication between the adapter and the drive.	2
	Conf.err	Adapter configuration error: The major or minor revision code of the common program revision in the fieldbus adapter module is not the revision required by the module (see parameter 51.32 FBA comm sw ver) or mapping file upload has failed more than three times.	3
	Off-line	Adapter is off-line.	4
	On-line	Adapter is on-line.	5
	Reset	Adapter is performing a hardware reset.	6

No.	Name/Value	Description	FbEq
51.32	FBA comm sw ver	Displays the common program revision of the adapter module in format axyz, where a = major revision number, xy = minor revision numbers. z = correction letter. Example: 190A = revision 1.90A.	
		Common program version of adapter module.	1 = 1
51.33	FBA appl sw ver	Displays the application program revision of the adapter module in format axyz, where: a = major revision number, xy = minor revision numbers, z = correction letter. Example: 190A = revision 1.90A.	
		Application program revision of adapter module.	1 = 1

52 FBA data in		Selection of data to be transferred from drive to fieldbus controller.	
52.01	FBA data in1	Parameters 52.01 ... 52.12 select data to be transferred from the drive to the fieldbus controller.	
	4	Status Word (16 bits)	4
	5	Actual value 1 (16 bits)	5
	6	Actual value 2 (16 bits)	6
	14	Status Word (32 bits)	14
	15	Actual value 1 (32 bits)	15
	16	Actual value 2 (32 bits)	16
	101...9999	Parameter index	1 = 1
...
52.12	FBA data in12	See parameter 52.01 FBA data in1 .	

53 FBA data out		Selection of data to be transferred from fieldbus controller to drive.	
53.01	FBA data out1	Parameters 53.01 ... 53.12 select data to be transferred from the fieldbus controller to the drive.	
	1	Control Word (16 bits)	1
	2	Reference REF1 (16 bits)	2
	3	Reference REF2 (16 bits)	3
	11	Control Word (32 bits)	11
	12	Reference REF1 (32 bits)	12
	13	Reference REF2 (32 bits)	13
	101...9999	Parameter index	1 = 1
...
53.12	FBA data out12	See parameter 53.01 FBA data out1 .	

56 Panel display		Selection of signals to be displayed on control panel.	
56.01	Signal1 param	Selects the first signal to be displayed on the optional control panel. The default signal is 01.03 Output frequency .	
	00.00 ... 255.255	1st signal to be displayed.	-
56.02	Signal2 param	Selects the second signal to be displayed on the optional control panel. The default signal is 01.04 Motor current .	
	00.00 ... 255.255	2nd signal to be displayed.	-

No.	Name/Value	Description	FbEq
56.03	Signal3 param	Selects the third signal to be displayed on the optional control panel. The default signal is 01.06 Motor torque .	
	00.00 ... 255.255	3rd signal to be displayed.	-
56.04	Signal1 mode	Defines the way the signal selected by parameter 56.01 Signal1 param is displayed on the optional control panel.	
	Disabled	Signal not displayed. Any other signals that are not disabled are shown together with their respective signal name.	-1
	Normal	Shows the signal as a numerical value followed by unit.	0
	Bar	Shows the signal as a horizontal bar.	1
	Drive name	Shows the drive name. (The drive name can be set using the DriveStudio PC tool.)	2
	Drive type	Shows the drive type.	3
56.05	Signal2 mode	Defines the way the signal selected by parameter 56.02 Signal2 param is displayed on the optional control panel.	
	Disabled	Signal not displayed. Any other signals that are not disabled are shown together with their respective signal name.	-1
	Normal	Shows the signal as a numerical value followed by unit.	0
	Bar	Shows the signal as a horizontal bar.	1
	Drive name	Shows the drive name. (The drive name can be set using the DriveStudio PC tool.)	2
	Drive type	Shows the drive type.	3
56.06	Signal3 mode	Defines the way the signal selected by parameter 56.03 Signal3 param is displayed on the optional control panel.	
	Disabled	Signal not displayed. Any other signals that are not disabled are shown together with their respective signal name.	-1
	Normal	Shows the signal as a numerical value followed by unit.	0
	Bar	Shows the signal as a horizontal bar.	1
	Drive name	Shows the drive name. (The drive name can be set using the DriveStudio PC tool.)	2
	Drive type	Shows the drive type.	3
57 D2D communication		Configuration of drive-to-drive communication. See also section Drive-to-drive link on page 61 .	
57.01	Link mode	Activates the drive-to-drive connection.	
	Disabled	Drive-to-drive connection disabled.	0
	Follower	The drive is a follower on the drive-to-drive link.	1
	Master	The drive is the master on the drive-to-drive link. Only one drive can be the master at a time.	2
57.02	Comm loss func	Selects how the drive acts when an erroneous drive-to-drive configuration or a communication break is detected.	
	No	Protection not active.	0
	Alarm	The drive generates an alarm.	1
	Fault	The drive trips on a fault.	2

No.	Name/Value	Description	FbEq
57.03	Node address	Sets the node address for a follower drive. Each follower must have a dedicated node address. Note: If the drive is set to be the master on the drive-to-drive link, this parameter has no effect (the master is automatically assigned node address 0).	
	1 ... 62	Node address.	1 = 1
57.04	Follower mask 1	On the master drive, selects the followers to be polled. If no response is received from a polled follower, the action selected by parameter 57.02 Comm loss func is taken. The least significant bit represents follower with node address 1, while the most significant bit represents follower 31. When a bit is set to 1, the corresponding node address is polled. For example, followers 1 and 2 are polled when this parameter is set to the value of 0x3.	
	0h00000000 ... 0h7FFFFFFF	Follower mask 1.	1 = 1
57.05	Follower mask 2	On the master drive, selects the followers to be polled. If no response is received from a polled follower, the action selected by parameter 57.02 Comm loss func is taken. The least significant bit represents follower with node address 32, while the most significant bit represents follower 62. When a bit is set to 1, the corresponding node address is polled. For example, followers 32 and 33 are polled when this parameter is set to the value of 0x3.	
	0h00000000 ... 0h7FFFFFFF	Follower mask 2.	1 = 1
57.06	Ref 1 src	Selects the source of D2D reference 1 sent to the followers. The parameter is effective on the master drive, as well as intermediate followers in a multicast message chain (see parameter 57.11 Ref1 msg type).	
	Pointer	Value pointer setting (see Terms and abbreviations on page 93).	-
57.07	Ref 2 src	On the master drive, selects the source of D2D reference 2 broadcast to all followers.	
	Pointer	Value pointer setting (see Terms and abbreviations on page 93).	-
57.08	Follower cw src	Selects the source of the D2D control word sent to the followers. The parameter is effective on the master drive, as well as intermediate followers in a multicast message chain (see parameter 57.11 Ref1 msg type).	
	Pointer	Value pointer setting (see Terms and abbreviations on page 93).	-
57.11	Ref1 msg type	By default, in drive-to-drive communication, the master broadcasts the drive-to-drive control word and references 1 and 2 to all followers. This parameter enables multicasting, i.e. sending the drive-to-drive control word and reference 1 to a certain drive or group of drives. The message can then be further relayed to another group of drives to form a multicast chain. In the master, as well as any intermediate followers (i.e. followers relaying the message to other followers), the sources for the control word and reference 1 are selected by parameters 57.08 Follower cw src and 57.06 Ref 1 src respectively. Note: Reference 2 is broadcast to all followers.	

No.	Name/Value	Description	FbEq
	Broadcast	The control word and reference 1 are sent by the master to all followers. If the master has this setting, the parameter has no effect in the followers.	0
	Ref1 MC Grps	The drive-to-drive control word and reference 1 are only sent to the drives in the multicast group specified by parameter 57.13 Next ref1 mc grp . This setting can also be used in intermediate followers to form a multicast chain.	1
57.12	Ref1 mc group	Selects the multicast group the drive belongs to. See parameter 57.11 Ref1 msg type .	
	0...62	Multicast group.	1 = 1
57.13	Next ref1 mc grp	Specifies the next multicast group of drives the multicast message is relayed to. See parameter 57.11 Ref1 msg type . This parameter is effective only in the master or intermediate followers (i.e. followers relaying the message to other followers).	
	0	No group selected.	0
	1...62	Next multicast group in the chain.	1 = 1
57.14	Nr ref1 mc grps	In the master drive, sets the total number of links (followers or groups of followers) in the multicast message chain. See parameter 57.11 Ref1 msg type . Notes: <ul style="list-style-type: none"> This parameter has no effect if the drive is a follower. The master counts as a member of the chain if acknowledgement from the last drive to the master is desired. 	
	1...62	Number of links in the multicast chain.	1 = 1
57.15	D2D com port	Defines the hardware to which the drive-to-drive link is connected. In special cases (such as harsh operating conditions), the galvanic isolation provided by the RS-485 interface of the FSCA module may make for more robust communication than the standard drive-to-drive connection.	
	on-board	Connector X5 on the JCU Control Unit is used.	0
	Slot 1	An FSCA module installed in JCU option slot 1 is used.	1
	Slot 2	An FSCA module installed in JCU option slot 2 is used.	2
	Slot 3	An FSCA module installed in JCU option slot 3 is used.	3
64 Load analyzer		Peak value and amplitude logger settings. See also section Load analyzer on page 64.	
64.01	PVL signal	Selects the signal to be monitored by the peak value logger. The signal is filtered using the filtering time specified by parameter 64.02 PVL filt time . The peak value is stored, along with other pre-selected signals at the time, into parameters 64.06...64.11 . Parameter 64.03 Reset loggers resets both the peak value logger and amplitude logger 2. The latest time the loggers were reset is stored into parameter 64.13 .	
	Speed rpm	01.01 Motor speed rpm (see page 94).	1073742081
	Speed %	01.02 Motor speed % (see page 94).	1073742082
	Frequency	01.03 Output frequency (see page 94).	1073742083
	Current	01.04 Motor current (see page 94).	1073742084
	Current %	01.05 Motor current % (see page 94).	1073742085

No.	Name/Value	Description	FbEq
	Torque	01.06 Motor torque (see page 94).	1073742086
	Dc-voltage	01.07 Dc-voltage (see page 94).	1073742087
	Power inu	01.22 Power inu out (see page 94).	1073742102
	Power motor	01.23 Motor power (see page 94).	1073742103
	Process act	04.03 Process act (see page 102).	1073742851
	Proc PID out	04.05 Process PID out (see page 102).	1073742853
	Pointer	Value pointer setting (see Terms and abbreviations on page 93).	-
64.02	PVL filt time	Peak value logger filtering time. See parameter 64.01 PVL signal .	
	0.00 ... 120.00 s	Peak value logger filtering time.	100 = 1 s
64.03	Reset loggers	Selects the signal to reset the peak value logger and amplitude logger 2. (Amplitude logger 1 cannot be reset.)	
	Const	Bit pointer setting (see Terms and abbreviations on page 93).	-
	Pointer		
64.04	AL signal	<p>Selects the signal to be monitored by amplitude logger 2. The signal is sampled at 200 ms intervals when the drive is running.</p> <p>The results are displayed by parameters 64.24...64.33. Each parameter represents an amplitude range, and shows what portion of the samples fall within that range.</p> <p>The signal value corresponding to 100% is defined by parameter 64.05 AL signal base.</p> <p>Parameter 64.03 Reset loggers resets both the peak value logger and amplitude logger 2. The latest time the loggers were reset is stored into parameter 64.13.</p> <p>Note: Amplitude logger 1 is fixed to monitor motor current (01.04 Motor current). The results are displayed by parameters 64.14...64.23. 100% of the signal value corresponds to the nominal output current of the drive (see the appropriate <i>Hardware Manual</i>).</p>	
	Speed rpm	01.01 Motor speed rpm (see page 94).	1073742081
	Speed %	01.02 Motor speed % (see page 94).	1073742082
	Frequency	01.03 Output frequency (see page 94).	1073742083
	Current	01.04 Motor current (see page 94).	1073742084
	Current %	01.05 Motor current % (see page 94).	1073742085
	Torque	01.06 Motor torque (see page 94).	1073742086
	Dc-voltage	01.07 Dc-voltage (see page 94).	1073742087
	Power inu	01.22 Power inu out (see page 94).	1073742102
	Power motor	01.23 Motor power (see page 94).	1073742103
	Process act	04.03 Process act (see page 102).	1073742851
	Proc PID out	04.05 Process PID out (see page 102).	1073742853
	Pointer	Value pointer setting (see Terms and abbreviations on page 93).	-
64.05	AL signal base	Defines the signal value that corresponds to 100% amplitude.	
	0.00 ... 32768.00	Signal value corresponding to 100%.	100 = 1

222 Parameters

No.	Name/Value	Description	FbEq
64.06	PVL peak value1	Peak value recorded by the peak value logger.	
	-32768.00 ... 32768.00	Peak value.	100 = 1
64.07	Date of peak	The date on which the peak value was recorded.	
	01.01.80 ...	Peak occurrence date (dd.mm.yy).	1 = 1 d
64.08	Time of peak	The time at which the peak value was recorded.	
	00:00:00 ... 23:59:59	Peak occurrence time.	1 = 1 s
64.09	Current at peak	Motor current at the moment the peak value was recorded.	
	-32768.00 ... 32768.00 A	Motor current at peak.	100 = 1 A
64.10	Dc volt at peak	Voltage in the intermediate DC circuit of the drive at the moment the peak value was recorded.	
	0.00 ... 2000.00 V	DC voltage at peak.	100 = 1 V
64.11	Speed at peak	Motor speed at the moment the peak value was recorded.	
	-32768.00 ... 32768.00 rpm	Motor speed at peak.	100 = 1 rpm
64.12	Date of reset	The date the peak value logger and amplitude logger 2 were last reset.	
	01.01.80 ...	Last reset date of loggers (dd.mm.yy).	1 = 1 d
64.13	Time of reset	The time the peak value logger and amplitude logger 2 were last reset.	
	00:00:00 ... 23:59:59	Last reset time of loggers.	1 = 1 s
64.14	AL1 0 to 10%	Percentage of samples recorded by amplitude logger 1 that fall between 0 and 10%.	
	0.00 ... 100.00%	Amplitude logger 1 samples between 0 and 10%.	100 = 1%
64.15	AL1 10 to 20%	Percentage of samples recorded by amplitude logger 1 that fall between 10 and 20%.	
	0.00 ... 100.00%	Amplitude logger 1 samples between 10 and 20%.	100 = 1%
64.16	AL1 20 to 30%	Percentage of samples recorded by amplitude logger 1 that fall between 20 and 30%.	
	0.00 ... 100.00%	Amplitude logger 1 samples between 20 and 30%.	100 = 1%
64.17	AL1 30 to 40%	Percentage of samples recorded by amplitude logger 1 that fall between 30 and 40%.	
	0.00 ... 100.00%	Amplitude logger 1 samples between 30 and 40%.	100 = 1%
64.18	AL1 40 to 50%	Percentage of samples recorded by amplitude logger 1 that fall between 40 and 50%.	
	0.00 ... 100.00%	Amplitude logger 1 samples between 40 and 50%.	100 = 1%
64.19	AL1 50 to 60%	Percentage of samples recorded by amplitude logger 1 that fall between 50 and 60%.	
	0.00 ... 100.00%	Amplitude logger 1 samples between 50 and 60%.	100 = 1%
64.20	AL1 60 to 70%	Percentage of samples recorded by amplitude logger 1 that fall between 60 and 70%.	
	0.00 ... 100.00%	Amplitude logger 1 samples between 60 and 70%.	100 = 1%

No.	Name/Value	Description	FbEq
64.21	AL1 70 to 80%	Percentage of samples recorded by amplitude logger 1 that fall between 70 and 80%.	
	0.00 ... 100.00%	Amplitude logger 1 samples between 70 and 80%.	100 = 1%
64.22	AL1 80 to 90%	Percentage of samples recorded by amplitude logger 1 that fall between 80 and 90%.	
	0.00 ... 100.00%	Amplitude logger 1 samples between 80 and 90%.	100 = 1%
64.23	AL1 over 90%	Percentage of samples recorded by amplitude logger 1 that exceed 90%.	
	0.00 ... 100.00%	Amplitude logger 1 samples over 90%.	100 = 1%
64.24	AL2 0 to 10%	Percentage of samples recorded by amplitude logger 2 that fall between 0 and 10%.	
	0.00 ... 100.00%	Amplitude logger 2 samples between 0 and 10%.	100 = 1%
64.25	AL2 10 to 20%	Percentage of samples recorded by amplitude logger 2 that fall between 10 and 20%.	
	0.00 ... 100.00%	Amplitude logger 2 samples between 10 and 20%.	100 = 1%
64.26	AL2 20 to 30%	Percentage of samples recorded by amplitude logger 2 that fall between 20 and 30%.	
	0.00 ... 100.00%	Amplitude logger 2 samples between 20 and 30%.	100 = 1%
64.27	AL2 30 to 40%	Percentage of samples recorded by amplitude logger 2 that fall between 30 and 40%.	
	0.00 ... 100.00%	Amplitude logger 2 samples between 30 and 40%.	100 = 1%
64.28	AL2 40 to 50%	Percentage of samples recorded by amplitude logger 2 that fall between 40 and 50%.	
	0.00 ... 100.00%	Amplitude logger 2 samples between 40 and 50%.	100 = 1%
64.29	AL2 50 to 60%	Percentage of samples recorded by amplitude logger 2 that fall between 50 and 60%.	
	0.00 ... 100.00%	Amplitude logger 2 samples between 50 and 60%.	100 = 1%
64.30	AL2 60 to 70%	Percentage of samples recorded by amplitude logger 2 that fall between 60 and 70%.	
	0.00 ... 100.00%	Amplitude logger 2 samples between 60 and 70%.	100 = 1%
64.31	AL2 70 to 80%	Percentage of samples recorded by amplitude logger 2 that fall between 70 and 80%.	
	0.00 ... 100.00%	Amplitude logger 2 samples between 70 and 80%.	100 = 1%
64.32	AL2 80 to 90%	Percentage of samples recorded by amplitude logger 2 that fall between 80 and 90%.	
	0.00 ... 100.00%	Amplitude logger 2 samples between 80 and 90%.	100 = 1%
64.33	AL2 over 90%	Percentage of samples recorded by amplitude logger 2 that exceed 90%.	
	0.00 ... 100.00%	Amplitude logger 2 samples over 90%.	100 = 1%

No.	Name/Value	Description	FbEq
90 Enc module sel		Activation of encoder/resolver interfaces. See also section Encoder support on page 62.	
90.01	Encoder 1 sel	Activates the communication to optional encoder/resolver interface 1. Note: It is recommended that encoder interface 1 is used whenever possible since the data received through that interface is fresher than the data received through interface 2. On the other hand, when position values used in emulation are determined by the drive software, the use of encoder interface 2 is recommended as the values are transmitted earlier through interface 2 than through interface 1.	
	None	Inactive.	0
	FEN-01 TTL+	Communication active. Module type: FEN-01 TTL Encoder interface. Input: TTL encoder input with commutation support (X32).	1
	FEN-01 TTL	Communication active. Module type: FEN-01 TTL Encoder Interface. Input: TTL encoder input (X31).	2
	FEN-11 ABS	Communication active. Module type: FEN-11 Absolute Encoder Interface. Input: Absolute encoder input (X42).	3
	FEN-11 TTL	Communication active. Module type: FEN-11 Absolute Encoder Interface. Input: TTL encoder input (X41).	4
	FEN-21 RES	Communication active. Module type: FEN-21 Resolver Interface. Input: Resolver input (X52).	5
	FEN-21 TTL	Communication active. Module type: FEN-21 Resolver Interface. Input: TTL encoder input (X51).	6
	FEN-31 HTL	Communication active. Module type: FEN-31 HTL Encoder Interface. Input: HTL encoder input (X82).	7
90.02	Encoder 2 sel	Activates the communication to the optional encoder/resolver interface 2. Note: The counting of shaft revolutions is not supported for encoder 2.	
	None	Inactive.	0
	FEN-01 TTL+	See parameter 90.01 Encoder 1 sel.	1
	FEN-01 TTL	See parameter 90.01 Encoder 1 sel.	2
	FEN-11 ABS	See parameter 90.01 Encoder 1 sel.	3
	FEN-11 TTL	See parameter 90.01 Encoder 1 sel.	4
	FEN-21 RES	See parameter 90.01 Encoder 1 sel.	5
	FEN-21 TTL	See parameter 90.01 Encoder 1 sel.	6
	FEN-31 HTL	See parameter 90.01 Encoder 1 sel.	7
90.04	TTL echo sel	Enables and selects the interface for the TTL encoder signal echo. Note: If encoder emulation and echo are enabled for the same FEN-xx TTL output, the emulation overrides the echo.	
	Disabled	No echo interface enabled.	0
	FEN-01 TTL+	Module type: FEN-01 TTL Encoder Interface. Echo: TTL encoder input (X32) pulses are echoed to the TTL output.	1
	FEN-01 TTL	Module type: FEN-01 TTL Encoder Interface. Echo: TTL encoder input (X31) pulses are echoed to the TTL output.	2

No.	Name/Value	Description	FbEq
	FEN-11 TTL	Module type: FEN-11 Absolute Encoder Interface. Echo: TTL encoder input (X41) pulses are echoed to the TTL output.	3
	FEN-21 TTL	Module type: FEN-21 Resolver Interface. Echo: TTL encoder input (X51) pulses are echoed to the TTL output.	4
	FEN-31 HTL	Module type: FEN-31 HTL Encoder Interface. Echo: HTL encoder input (X82) pulses are echoed to the TTL output.	5
90.05	Enc cable fault	Selects the action in case an encoder cable fault is detected by the FEN-xx encoder interface.	
	No	Cable fault detection inactive.	0
	Fault	The drive trips on an ENCODER 1/2 CABLE fault.	1
	Warning	The drive generates an ENCODER 1/2 CABLE warning. This is the recommended setting if the maximum pulse frequency of sine/cosine incremental signals exceeds 100 kHz; at high frequencies, the signals may attenuate enough to invoke the function. The maximum pulse frequency can be calculated as follows: $\text{Max. pulse frequency} = \frac{\text{Pulses per rev.} \times \text{Max. speed in rpm}}{60}$	2
90.10	Enc par refresh	Setting this parameter to 1 forces a reconfiguration of the FEN-xx interfaces, which is needed for any parameter changes in groups 90...93 to take effect. Note: The parameter cannot be changed while the drive is running.	
	Done	Reconfiguration done.	0
	Configure	Reconfigure. The value will automatically revert to <i>Done</i> .	1
91 Absol enc conf		Absolute encoder configuration. See also section Encoder support on page 62.	
91.01	Sine cosine nr	Defines the number of sine/cosine wave cycles within one revolution. Note: This parameter does not need to be set when EnDat or SSI encoders are used in continuous mode. See parameter 91.25 SSI mode / 91.30 Endat mode .	
	0...65535	Number of sine/cosine wave cycles.	1 = 1
91.02	Abs enc interf	Selects the source for the encoder position (zero position).	
	None	Not selected.	0
	Commut sig	Commutation signals.	1
	EnDat	Serial interface: EnDat encoder.	2
	Hiperface	Serial interface: HIPERFACE encoder.	3
	SSI	Serial interface: SSI encoder.	4
	Tamag. 17/33b	Serial interface: Tamagawa 17/33-bit encoder.	5
91.03	Rev count bits	Defines the number of bits used in revolution count (for multiturn encoders). Used with serial interfaces, i.e. when parameter 91.02 Abs enc interf setting is <i>EnDat</i> , <i>Hiperface</i> , <i>SSI</i> or <i>Tamag. 17/33b</i> .	
	0...32	Number of bits. For example, 4096 revolutions corresponds to 12 bits.	1 = 1

No.	Name/Value	Description	FbEq
91.04	Pos data bits	Defines the number of bits used within one revolution. Used with serial interfaces, i.e. when parameter 91.02 Abs enc interf setting is EnDat , Hiperface , SSI or Tamag. 17/33b .	
	0...32	Number of bits. For example, 32768 positions per revolution corresponds to 15 bits.	1 = 1
91.05	Refmark ena	Enables the encoder zero pulse (if used). Zero pulse can be used for position latching. Note: With serial interfaces (i.e. when parameter 91.02 Abs enc interf setting is EnDat , Hiperface , SSI or Tamag. 17/33b), zero pulse must be disabled.	
	False	Zero pulse disabled.	0
	True	Zero pulse enabled.	1
91.10	Hiperface parity	Defines the use of parity and stop bits for HIPERFACE encoder (i.e. when parameter 91.02 Abs enc interf setting is Hiperface). Typically, this parameter does not need to be set.	
	Odd	Odd parity indication bit, one stop bit.	0
	Even	Even parity indication bit, one stop bit.	1
91.11	Hiperf baudrate	Defines the transfer rate of the link for HIPERFACE encoder (i.e. when parameter 91.02 Abs enc interf setting is Hiperface). Typically, this parameter does not need to be set.	
	4800	4800 bit/s	0
	9600	9600 bit/s	1
	19200	19200 bit/s	2
	38400	38400 bit/s	3
91.12	Hiperf node addr	Defines the node address for HIPERFACE encoder (i.e. when parameter 91.02 Abs enc interf setting is Hiperface). Typically, this parameter does not need to be set.	
	0...255	HIPERFACE encoder node address.	1 = 1
91.20	SSI clock cycles	Defines the length of the SSI message. The length is defined as the number of clock cycles. The number of cycles can be calculated by adding 1 to the number of bits in an SSI message frame. Used with SSI encoders, i.e. when parameter 91.02 Abs enc interf setting is SSI .	
	2...127	Length of SSI message.	1 = 1
91.21	SSI position msb	Defines the location of the MSB (most significant bit) of the position data within an SSI message. Used with SSI encoders, i.e. when parameter 91.02 Abs enc interf setting is SSI .	
	1...126	Location of MSB (bit number) in SSI position data.	1 = 1
91.22	SSI revol msb	Defines the location of the MSB (most significant bit) of the revolution count within an SSI message. Used with SSI encoders, i.e. when parameter 91.02 Abs enc interf setting is SSI .	
	1...126	Location of MSB (bit number) in SSI revolution count.	1 = 1
91.23	SSI data format	Selects the data format for SSI encoder (i.e. when parameter 91.02 Abs enc interf setting is SSI).	
	binary	Binary data format.	0
	gray	Gray data format.	1

No.	Name/Value	Description	FbEq
91.24	SSI baud rate	Selects the baud rate for SSI encoder (i.e. when parameter 91.02 Abs enc interf setting is <i>SSI</i>).	
	10 kbit/s	10 kbit/s baud rate.	0
	50 kbit/s	50 kbit/s baud rate.	1
	100 kbit/s	100 kbit/s baud rate.	2
	200 kbit/s	200 kbit/s baud rate.	3
	500 kbit/s	500 kbit/s baud rate.	4
	1000 kbit/s	1000 kbit/s baud rate.	5
91.25	SSI mode	Selects the SSI encoder mode. Note: This parameter needs to be set only when an SSI encoder is used in continuous mode, i.e. without incremental sin/cos signals (supported only as encoder 1). SSI encoder is selected by setting parameter 91.02 Abs enc interf to <i>SSI</i> .	
	Initial pos.	Single position transfer mode (initial position).	0
	Continuous	Continuous position transfer mode.	1
91.26	SSI transmit cyc	Selects the transmission cycle for SSI encoder. Note: This parameter needs to be set only when an SSI encoder is used in continuous mode, i.e. without incremental sin/cos signals (supported only as encoder 1). SSI encoder is selected by setting parameter 91.02 Abs enc interf to <i>SSI</i> .	
	50 μ s	50 μ s transmission cycle.	0
	100 μ s	100 μ s transmission cycle.	1
	200 μ s	200 μ s transmission cycle.	2
	500 μ s	500 μ s transmission cycle.	3
	1 ms	1 ms transmission cycle.	4
	2 ms	2 ms transmission cycle.	5
91.27	SSI zero phase	Defines the phase angle within one sine/cosine signal period that corresponds to the value of zero on the SSI serial link data. The parameter is used to adjust the synchronization of the SSI position data and the position based on sine/cosine incremental signals. Incorrect synchronization may cause an error of ± 1 incremental period. Note: This parameter needs only be set when an SSI encoder with sine/cosine incremental signals is used in initial position mode.	
	315-45 deg	315...45° phase angle.	0
	45-135 deg	45...135° phase angle.	1
	135-225 deg	135...225° phase angle.	2
	225-315 deg	225...315° phase angle.	3
91.30	Endat mode	Selects the EnDat encoder mode. Note: This parameter needs to be set only when an EnDat encoder is used in continuous mode, i.e. without incremental sin/cos signals (supported only as encoder 1). EnDat encoder is selected by setting parameter 91.02 Abs enc interf to <i>EnDat</i> .	
	Initial pos.	Single position data transfer (initial position).	0
	Continuous	Continuous position data transfer mode.	1

No.	Name/Value	Description	FbEq
91.31	Endat max calc	Selects the maximum encoder calculation time for EnDat encoder. Note: This parameter needs to be set only when an EnDat encoder is used in continuous mode, i.e. without incremental sin/cos signals (supported only as encoder 1). EnDat encoder is selected by setting parameter 91.02 Abs enc interf to EnDat .	
	10 µs	10 µs maximum calculation time.	0
	100 µs	100 µs maximum calculation time.	1
	1 ms	1 ms maximum calculation time.	2
	50 ms	50 ms maximum calculation time.	3

92 Resolver conf		Resolver configuration.	
92.01	Resolv polepairs	Selects the number of pole pairs.	
	1 ... 32	Number of pole pairs.	1 = 1
92.02	Exc signal ampl	Defines the amplitude of the excitation signal.	
	4.0 ... 12.0 Vrms	Amplitude of excitation signal.	10 = 1 Vrms
92.03	Exc signal freq	Defines the frequency of the excitation signal.	
	1 ... 20 kHz	Frequency of excitation signal.	1 = 1 kHz

93 Pulse enc conf		Pulse encoder configuration.	
93.01	Enc1 pulse nr	Defines the pulse number per revolution for encoder 1.	
	0 ... 65535	Number of pulses for encoder 1.	1 = 1
93.02	Enc1 type	Selects the type of the encoder 1.	
	Quadrature	Quadrature encoder (has two channels, A and B)	0
	Single track	Single track encoder (has one channel, A)	1
93.03	Enc1 sp CalcMode	Selects the speed calculation mode for encoder 1.	
	A&B all	Channels A and B: Rising and falling edges are used for speed calculation. Channel B: Defines the direction of rotation. Notes: <ul style="list-style-type: none"> When single track mode has been selected by parameter 93.02 Enc1 type, this setting acts like the setting A all. When single track mode has been selected by parameter 93.02 Enc1 type, the speed is always positive. 	0
	A all	Channel A: Rising and falling edges are used for speed calculation. Channel B: Defines the direction of rotation. Note: When single track mode has been selected by parameter 93.02 Enc1 type , the speed is always positive.	1
	A rising	Channel A: Rising edges are used for speed calculation. Channel B: Defines the direction of rotation. Note: When single track mode has been selected by parameter 93.02 Enc1 type , the speed is always positive.	2
	A falling	Channel A: Falling edges are used for speed calculation. Channel B: Defines the direction of rotation. Note: When single track mode has been selected by parameter 93.02 Enc1 type , the speed is always positive.	3

No.	Name/Value	Description	FbEq								
	Auto rising	One of the above modes is selected automatically depending on the pulse frequency as follows: <table border="1"> <thead> <tr> <th>Pulse frequency of the channel(s)</th> <th>Mode used</th> </tr> </thead> <tbody> <tr> <td>< 2442 Hz</td> <td><i>A&B all</i></td> </tr> <tr> <td>2442...4884 Hz</td> <td><i>A all</i></td> </tr> <tr> <td>> 4884 Hz</td> <td><i>A rising</i></td> </tr> </tbody> </table>	Pulse frequency of the channel(s)	Mode used	< 2442 Hz	<i>A&B all</i>	2442...4884 Hz	<i>A all</i>	> 4884 Hz	<i>A rising</i>	4
Pulse frequency of the channel(s)	Mode used										
< 2442 Hz	<i>A&B all</i>										
2442...4884 Hz	<i>A all</i>										
> 4884 Hz	<i>A rising</i>										
	Auto falling	One of the above modes is selected automatically depending on the pulse frequency as follows: <table border="1"> <thead> <tr> <th>Pulse frequency of the channel(s)</th> <th>Mode used</th> </tr> </thead> <tbody> <tr> <td>< 2442 Hz</td> <td><i>A&B all</i></td> </tr> <tr> <td>2442...4884 Hz</td> <td><i>A all</i></td> </tr> <tr> <td>> 4884 Hz</td> <td><i>A falling</i></td> </tr> </tbody> </table>	Pulse frequency of the channel(s)	Mode used	< 2442 Hz	<i>A&B all</i>	2442...4884 Hz	<i>A all</i>	> 4884 Hz	<i>A falling</i>	5
Pulse frequency of the channel(s)	Mode used										
< 2442 Hz	<i>A&B all</i>										
2442...4884 Hz	<i>A all</i>										
> 4884 Hz	<i>A falling</i>										
93.11	Enc2 pulse nr	Defines the pulse number per revolution for encoder 2.									
	0 ... 65535	Number of pulses for encoder 2.	1 = 1								
93.12	Enc2 type	Selects the type of the encoder 2.									
	Quadrature	Quadrature encoder (has two channels, A and B)	0								
	Single track	Single track encoder (has one channel, A)	1								
93.13	Enc2 sp CalcMode	Selects the speed calculation mode for encoder 2.									
	A&B all	See parameter 93.03 Enc1 sp CalcMode .	0								
	A all	See parameter 93.03 Enc1 sp CalcMode .	1								
	A rising	See parameter 93.03 Enc1 sp CalcMode .	2								
	A falling	See parameter 93.03 Enc1 sp CalcMode .	3								
	Auto rising	See parameter 93.03 Enc1 sp CalcMode .	4								
	Auto falling	See parameter 93.03 Enc1 sp CalcMode .	5								
94 Ext IO conf		I/O extension configuration.									
94.01	Ext IO1 sel	Activates an I/O extension installed into Slot 1.									
	None	No extension installed into Slot 1.	0								
	FIO-01	FIO-01 extension installed into Slot 1.	1								
	FIO-11	FIO-11 extension installed into Slot 1.	2								
	FIO-21	FIO-21 extension installed into Slot 1.	3								
94.02	Ext IO2 sel	Activates an I/O extension installed into Slot 2.									
	None	No 2nd extension installed into Slot 2.	0								
	FIO-01	FIO-01 extension installed into Slot 2.	1								
	FIO-11	FIO-11 extension installed into Slot 2.	2								
	FIO-21	FIO-21 extension installed into Slot 2.	3								
95 Hw configuration		Diverse hardware-related settings.									
95.01	Ctrl boardSupply	Selects how the drive control unit is powered.									
	Internal 24V	The drive control unit is powered from the drive power unit it is mounted on. This is the default setting.	0								
	External 24V	The drive control unit is powered from an external power supply.	1								

No.	Name/Value	Description	FbEq
95.03	Temp inu ambient	Defines the maximum ambient temperature. The value is used by the drive cooling diagnostics.	
	0 ... 55 °C	Drive ambient temperature.	1 = 1 °C
97 User motor par		Motor values supplied by the user that are used in the motor model.	
97.01	Use given params	Activates the motor model parameters 97.02...97.14 and the rotor angle offset parameter 97.20 . Notes: <ul style="list-style-type: none"> Parameter value is automatically set to zero when ID run is selected by parameter 99.13 IDrun mode. The values of parameters 97.02...97.20 are updated according to the motor characteristics identified during the ID run. This parameter cannot be changed while the drive is running. 	
	NoUserPars	Parameters 97.02...97.20 inactive.	0
	UserMotPars	The values of parameters 97.02...97.14 are used in the motor model.	1
	UserPosOffs	The value of parameter 97.20 is used as the rotor angle offset. Parameters 97.02...97.14 are inactive.	2
	AllUserPars	The values of parameters 97.02...97.14 are used in the motor model, and the value of parameter 97.20 is used as the rotor angle offset.	3
97.02	Rs user	Defines the stator resistance R_S of the motor model.	
	0.00000 ... 0.50000 p.u.	Stator resistance in per unit.	100000 = 1 p.u.
97.03	Rr user	Defines the rotor resistance R_R of the motor model. Note: This parameter is valid only for asynchronous motors.	
	0.00000 ... 0.50000 p.u.	Rotor resistance in per unit.	100000 = 1 p.u.
97.04	Lm user	Defines the main inductance L_M of the motor model. Note: This parameter is valid only for asynchronous motors.	
	0.00000 ... 10.00000 p.u.	Main inductance in per unit.	100000 = 1 p.u.
97.05	SigmaL user	Defines the leakage inductance σL_S . Note: This parameter is valid only for asynchronous motors.	
	0.00000 ... 1.00000 p.u.	Leakage inductance in per unit.	100000 = 1 p.u.
97.06	Ld user	Defines the direct axis (synchronous) inductance. Note: This parameter is valid only for permanent magnet motors.	
	0.00000 ... 10.00000 p.u.	Direct axis inductance in per unit.	100000 = 1 p.u.
97.07	Lq user	Defines the quadrature axis (synchronous) inductance. Note: This parameter is valid only for permanent magnet motors.	
	0.00000 ... 10.00000 p.u.	Quadrature axis inductance in per unit.	100000 = 1 p.u.

No.	Name/Value	Description	FbEq
97.08	Pm flux user	Defines the permanent magnet flux. Note: This parameter is valid only for permanent magnet motors.	
	0.00000 ... 2.00000 p.u	Permanent magnet flux in per unit.	100000 = 1 p.u.
97.09	Rs user SI	Defines the stator resistance R_S of the motor model.	
	0.00000 ... 100.00000 ohm	Stator resistance.	100000 = 1 ohm
97.10	Rr user SI	Defines the rotor resistance R_R of the motor model. Note: This parameter is valid only for asynchronous motors.	
	0.00000 ... 100.00000 ohm	Rotor resistance.	100000 = 1 ohm
97.11	Lm user SI	Defines the main inductance L_M of the motor model. Note: This parameter is valid only for asynchronous motors.	
	0.00 ... 100000.00 mH	Main inductance.	100 = 1 mH
97.12	SigL user SI	Defines the leakage inductance σL_S . Note: This parameter is valid only for asynchronous motors.	
	0.00 ... 100000.00 mH	Leakage inductance.	100 = 1 mH
97.13	Ld user SI	Defines the direct axis (synchronous) inductance. Note: This parameter is valid only for permanent magnet motors.	
	0.00 ... 100000.00 mH	Direct axis inductance.	100 = 1 mH
97.14	Lq user SI	Defines the quadrature axis (synchronous) inductance. Note: This parameter is valid only for permanent magnet motors.	
	0.00 ... 100000.00 mH	Quadrature axis inductance.	100 = 1 mH
97.20	PM angle offset	Defines an angle offset between the zero position of the synchronous motor and the zero position of the position sensor. Notes: <ul style="list-style-type: none"> The value is in electrical degrees. The electrical angle equals the mechanical angle multiplied by the number of motor pole pairs. This parameter is valid only for permanent magnet motors. 	
	0...360°	Angle offset.	1 = 1°
99 Start-up data		Language selection, motor configuration and ID run settings.	
99.01	Language	Selects the language of the control panel displays. Note: Not all languages listed below are necessarily supported.	
	English	English.	
	Español	Spanish.	
	Deutsch	German.	
	Italiano	Italian.	
	Suomi	Finnish.	

No.	Name/Value	Description	FbEq
	Svenska	Swedish.	
	Türkçe	Turkish.	
99.04	Motor type	Selects the motor type. Note: This parameter cannot be changed while the drive is running.	
	AM	Asynchronous motor. Three-phase AC induction motor with squirrel cage rotor.	0
	PMSM	Permanent magnet motor. Three-phase AC synchronous motor with permanent magnet rotor and sinusoidal BackEMF voltage.	1
99.05	Motor ctrl mode	Selects the motor control mode.	
	DTC	Direct torque control. This mode is suitable for most applications. Note: Instead of direct torque control, use scalar control <ul style="list-style-type: none"> • with multimotor applications 1) if the load is not equally shared between the motors, 2) if the motors are of different sizes, or 3) if the motors are going to be changed after the motor identification (ID run), • if the nominal current of the motor is less than 1/6 of the nominal output current of the drive, • if the drive is used with no motor connected (for example, for test purposes), • if the drive runs a medium-voltage motor through a step-up transformer. 	0
	Scalar	Scalar control. This mode is suitable in special cases where DTC cannot be applied. In scalar control, the drive is controlled with a frequency reference. The outstanding motor control accuracy of DTC cannot be achieved in scalar control. Some standard features are disabled in scalar control mode. Note: Correct motor run requires that the magnetizing current of the motor does not exceed 90% of the nominal current of the inverter. See also section Scalar motor control on page 74.	1
99.06	Mot nom current	Defines the nominal motor current. Must be equal to the value on the motor rating plate. If multiple motors are connected to the drive, enter the total current of the motors. Notes: <ul style="list-style-type: none"> • Correct motor run requires that the magnetizing current of the motor does not exceed 90% of the nominal current of the drive. • This parameter cannot be changed while the drive is running. 	
	0.0 ... 6400.0 A	Nominal current of the motor. The allowable range is $1/6 \dots 2 \times I_{2N}$ of the drive ($0 \dots 2 \times I_{2N}$ with scalar control mode).	10 = 1 A

No.	Name/Value	Description	FbEq
99.07	Mot nom voltage	<p>Defines the nominal motor voltage as fundamental phase-to-phase rms voltage supplied to the motor at the nominal operating point. This setting must match the value on the rating plate of the motor.</p> <p>Notes:</p> <ul style="list-style-type: none"> • With permanent magnet motors, the nominal voltage is the BackEMF voltage at nominal speed of the motor. If the voltage is given as voltage per rpm, e.g. 60 V per 1000 rpm, the voltage for a nominal speed of 3000 rpm is $3 \times 60 \text{ V} = 180 \text{ V}$. Note that the nominal voltage is not equal to the equivalent DC motor voltage (EDCM) specified by some motor manufacturers. The nominal voltage can be calculated by dividing the EDCM voltage by 1.7 (or square root of 3). • The stress on the motor insulation is always dependent on the drive supply voltage. This also applies to the case where the motor voltage rating is lower than that of the drive and the supply. • This parameter cannot be changed while the drive is running. 	
	$1/6 \dots 2 \times U_N$	Nominal voltage of the motor.	$10 = 1 \text{ V}$
99.08	Mot nom freq	<p>Defines the nominal motor frequency.</p> <p>Note: This parameter cannot be changed while the drive is running.</p>	
	5.0 ... 500.0 Hz	Nominal frequency of the motor.	$10 = 1 \text{ V}$
99.09	Mot nom speed	<p>Defines the nominal motor speed. The setting must match the value on the rating plate of the motor.</p> <p>Note: This parameter cannot be changed while the drive is running.</p>	
	0 ... 10000 rpm	Nominal speed of the motor.	$1 = 1 \text{ rpm}$
99.10	Mot nom power	<p>Defines the nominal motor power. The setting must match the value on the rating plate of the motor. If multiple motors are connected to the drive, enter the total power of the motors. The unit is selected by parameter 16.17 Power unit.</p> <p>Note: This parameter cannot be changed while the drive is running.</p>	
	0.00 ... 10000.00 kW	Nominal power of the motor.	$100 = 1 \text{ kW}$
99.11	Mot nom cosφ	<p>Defines the cosφ of the motor for a more accurate motor model. (Not applicable to permanent magnet motors.) Not obligatory; if set, should match the value on the rating plate of the motor.</p> <p>Note: This parameter cannot be changed while the drive is running.</p>	
	0.00 ... 1.00	Cosφ of the motor.	$100 = 1$
99.12	Mot nom torque	<p>Defines the nominal motor shaft torque for a more accurate motor model. Not obligatory.</p> <p>Note: This parameter cannot be changed while the drive is running.</p>	
	0 ... 2147483.647 Nm	Nominal motor torque.	$1000 = 1 \text{ N}\cdot\text{m}$

No.	Name/Value	Description	FbEq
99.13	IDrun mode	<p>Selects the type of the motor identification performed at the next start of the drive (for Direct Torque Control). During the identification, the drive will identify the characteristics of the motor for optimum motor control. After the ID run, the drive is stopped. Note: This parameter cannot be changed while the drive is running.</p> <p>Once the ID run is activated, it can be cancelled by stopping the drive: If ID run has already been performed once, parameter is automatically set to NO. If no ID run has been performed yet, parameter is automatically set to <i>Standstill</i>. In this case, the ID run must be performed.</p> <p>Notes:</p> <ul style="list-style-type: none"> • ID run can only be performed in local control (i.e. when drive is controlled via PC tool or control panel). • ID run cannot be performed if parameter <i>99.05 Motor ctrl mode</i> is set to <i>Scalar</i>. • ID run must be performed every time any of the motor parameters (<i>99.04, 99.06...99.12</i>) have been changed. Parameter is automatically set to <i>Standstill</i> after the motor parameters have been set. <p>With permanent magnet motor, the motor shaft must NOT be locked and the load torque must be < 10% during the ID run (<i>Normal/Reduced/Standstill</i>).</p> <ul style="list-style-type: none"> • Ensure that possible Safe Torque Off and emergency stop circuits are closed during ID run. • Mechanical brake is not opened by the logic for the ID run. 	
	No	No motor ID run is requested. This mode can be selected only if the ID run (Normal/Reduced/Standstill) has already been performed once.	0
	Normal	<p>Normal ID run. Guarantees the best possible control accuracy. The ID run takes about 90 seconds. This mode should be selected whenever it is possible.</p> <p>Notes:</p> <ul style="list-style-type: none"> • The driven machinery must be de-coupled from the motor with Normal ID run, if the load torque is higher than 20%, or if the machinery is not able to withstand the nominal torque transient during the ID run. • Check the direction of rotation of the motor before starting the ID run. During the run, the motor will rotate in the forward direction. <p> WARNING! The motor will run at up to approximately 50...100% of the nominal speed during the ID run. ENSURE THAT IT IS SAFE TO RUN THE MOTOR BEFORE PERFORMING THE ID RUN!</p>	1

No.	Name/Value	Description	FbEq
	Reduced	<p>Reduced ID Run. This mode should be selected instead of the Normal ID Run if</p> <ul style="list-style-type: none"> • mechanical losses are higher than 20% (i.e. the motor cannot be de-coupled from the driven equipment), or if • flux reduction is not allowed while the motor is running (i.e. in case of a motor with an integrated brake supplied from the motor terminals). <p>With Reduced ID run, the control in the field weakening area or at high torques is not necessarily as accurate as with the Normal ID run. Reduced ID run is completed faster than the Normal ID Run (< 90 seconds).</p> <p>Note: Check the direction of rotation of the motor before starting the ID run. During the run, the motor will rotate in the forward direction.</p> <p> WARNING! The motor will run at up to approximately 50...100% of the nominal speed during the ID run. ENSURE THAT IT IS SAFE TO RUN THE MOTOR BEFORE PERFORMING THE ID RUN!</p>	2
	Standstill	<p>Standstill ID run. The motor is injected with DC current. With an asynchronous motor, the motor shaft is not rotating (with permanent magnet motor the shaft can rotate < 0.5 revolution).</p> <p>Note: This mode should be selected only if the <i>Normal</i> or <i>Reduced</i> ID run is not possible due to the restrictions caused by the connected mechanics (e.g. with lift or crane applications).</p>	3
	Autophasing	<p>During autophasing, the start angle of the motor is determined. Note that other motor model values are not updated. See also parameter 11.07 Autophasing mode.</p> <p>Notes:</p> <ul style="list-style-type: none"> • Autophasing can only be selected after the Normal/Reduced/Standstill ID run has been performed once. Autophasing is used when an absolute encoder has been added/changed to a permanent magnet motor and there is no need to perform the Normal/Reduced/Standstill ID run again. • During Autophasing, the motor shaft must NOT be locked and the load torque must be < 5%. 	4
	Cur meas cal	<p>Current offset and gain measurement calibration. The calibration will be performed at next start.</p>	5



Additional parameter data

What this chapter contains

This chapter lists the parameters with some additional data. For parameter descriptions, see chapter [Parameters](#) on page 93.

Terms and abbreviations

Term	Definition
Actual signal	Signal measured or calculated by the drive. Can be monitored by the user. No user setting is possible.
Bit pointer	Bit pointer. A bit pointer can point to a single bit in the value of another parameter, or be fixed to 0 (C.FALSE) or 1 (C.TRUE).
enum	Enumerated list, i.e. selection list.
FbEq	Fieldbus equivalent: The scaling between the value shown on the panel and the integer used in serial communication.
INT32	32-bit integer value (31 bits + sign).
No.	Parameter number.
Pb	Packed boolean.
REAL	$\underbrace{\text{16-bit value}} \quad \underbrace{\text{16-bit value}} \quad (31 \text{ bits} + \text{sign})$ = integer value = fractional value
REAL24	$\underbrace{\text{8-bit value}} \quad \underbrace{\text{24-bit value}} \quad (31 \text{ bits} + \text{sign})$ = integer value = fractional value

Type	Data type. See enum, INT32, Bit pointer, Val pointer, Pb, REAL, REAL24, UINT32.
UINT32	32-bit unsigned integer value.
Val pointer	Value pointer. Points to the value of another parameter.

Fieldbus addresses

Refer to the *User's Manual* of the fieldbus adapter.

Pointer parameter format in fieldbus communication

Value and bit pointer parameters are transferred between the fieldbus adapter and drive as 32-bit integer values.

■ 32-bit integer value pointers

When a value pointer parameter is connected to the value of another parameter, the format is as follows:

	Bit			
	30...31	16...29	8...15	0...7
Name	Source type		Group	Index
Value	1	-	1...255	1...255
Description	Value pointer is connected to parameter	-	Group of source parameter	Index of source parameter

When a value pointer parameter is connected to a solution program, the format is as follows:

	Bit		
	30...31	24...29	0...23
Name	Source type	Not in use	Address
Value	2	-	$0...2^{23}$
Description	Value pointer is connected to solution program.	-	Relative address of solution program variable

Note: Value pointer parameters connected to a solution program are read-only via fieldbus.

■ 32-bit integer bit pointers

When a bit pointer parameter is connected to value 0 or 1, the format is as follows:

	Bit		
	30...31	16...29	0
Name	Source type	Not in use	Value
Value	0	-	0...1
Description	Bit pointer is connected to 0/1.	-	0 = False, 1 = True

When a bit pointer parameter is connected to a bit value of another parameter, the format is as follows:

	Bit				
	30...31	24...29	16...23	8...15	0...7
Name	Source type	Not in use	Bit sel	Group	Index
Value	1	-	0...31	2...255	1...255
Description	Bit pointer is connected to signal bit value.	-	Bit selection	Group of source parameter	Index of source parameter

When a bit pointer parameter is connected to a solution program, the format is as follows:

	Bit		
	30...31	24...29	0...23
Name	Source type	Bit sel	Address
Value	2	0...31	$0...2^{23}$
Description	Bit pointer is connected to solution program.	Bit selection	Relative address of solution program variable

Note: Bit pointer parameters connected to a solution program are read-only via fieldbus.

Parameter groups 1...9

No.	Name	Type	Data length	Range	Unit	Update time	Notes
01 Actual values							
01.01	Motor speed rpm	REAL	32	-30000...30000	rpm	250 µs	
01.02	Motor speed %	REAL	32	-1000...1000	%	2 ms	
01.03	Output frequency	REAL	32	-30000...30000	Hz	2 ms	
01.04	Motor current	REAL	32	0...30000	A	10 ms	
01.05	Motor current %	REAL	16	0...1000	%	2 ms	
01.06	Motor torque	REAL	16	-1600...1600	%	2 ms	
01.07	Dc-voltage	REAL	32	0...2000	V	2 ms	
01.08	Encoder1 speed	REAL	32	-32768...32768	rpm	250 µs	
01.09	Encoder1 pos	REAL24	32	0...1	rev	250 µs	
01.10	Encoder2 speed	REAL	32	-32768...32768	rpm	250 µs	
01.11	Encoder2 pos	REAL24	32	0...1	rev	250 µs	
01.12	Pos act	REAL	32	-32768...32768	rev	2 ms	
01.13	Pos 2nd enc	REAL	32	-32768...32768	rev	2 ms	
01.14	Motor speed est	REAL	32	-30000...30000	rpm	2 ms	
01.15	Temp inverter	REAL24	16	-10...100	%	2 ms	
01.16	Temp brk chopper	REAL24	16	0...100	%	2 ms	
01.17	Motor temp1	REAL	16	-10...250	°C	10 ms	
01.18	Motor temp2	REAL	16	-10...250	°C	10 ms	
01.19	Used supply volt	REAL	16	0...1000	V	10 ms	
01.20	Brake res load	REAL24	16	0...1000	%	50 ms	
01.21	Cpu usage	UINT32	16	0...100	%	-	
01.22	Power inu out	REAL	32	-32768...32768	kW or hp	10 ms	
01.23	Motor power	REAL	32	-32768...32768	kW or hp	2 ms	
01.24	kWh inverter	INT32	32	0...2147483647	kWh	10 ms	
01.25	kWh supply	INT32	32	-2147483647 ... 2147483647	kWh	10 ms	
01.26	On-time counter	INT32	32	0...35791394.1	h	10 ms	
01.27	Run-time counter	INT32	32	0...35791394.1	h	10 ms	
01.28	Fan on-time	INT32	32	0...35791394.1	h	10 ms	
01.29	Torq nom scale	INT32	32	0...2147483.647	Nm	-	
01.30	Polepairs	INT32	16	0...1000	-	-	
01.31	Mech time const	REAL	32	0...32767	s	10 ms	
01.32	Temp phase A	REAL24	16	0...100	%	2 ms	
01.33	Temp phase B	REAL24	16	0...100	%	2 ms	
01.34	Temp phase C	REAL24	16	0...100	%	2 ms	
01.35	Saved energy	INT32	32	0...2147483647	kWh	10 ms	
01.36	Saved amount	INT32	32	0...2147483647	-	10 ms	
01.37	Saved CO2	INT32	32	0...2147483647	t	10 ms	
02 I/O values							
02.01	DI status	Pb	16	0b00000000 ... 0b11111111	-	2 ms	
02.02	RO status	Pb	16	0b00000000 ... 0b11111111	-	2 ms	
02.03	DIO status	Pb	16	0b0000000000 ... 0b1111111111	-	2 ms	
02.04	AI1	REAL	16	-11...11 V or -22...22 mA	V or mA	2 ms	
02.05	AI1 scaled	REAL	32	-32768...32768	-	2 ms	

No.	Name	Type	Data length	Range	Unit	Update time	Notes
02.06	<i>AI2</i>	REAL	16	-11...11 V or -22...22 mA	V or mA	2 ms	
02.07	<i>AI2 scaled</i>	REAL	32	-32768...32768	-	2 ms	
02.08	<i>AI3</i>	REAL	16	-22...22	mA	2 ms	
02.09	<i>AI3 scaled</i>	REAL	32	-32768...32768	-	2 ms	
02.10	<i>AI4</i>	REAL	16	-22...22	mA	2 ms	
02.11	<i>AI4 scaled</i>	REAL	32	-32768...32768	-	2 ms	
02.12	<i>AI5</i>	REAL	16	-22...22	mA	2 ms	
02.13	<i>AI5 scaled</i>	REAL	32	-32768...32768	-	2 ms	
02.14	<i>AI6</i>	REAL	16	-22...22	mA	2 ms	
02.15	<i>AI6 scaled</i>	REAL	32	-32768...32768	-	2 ms	
02.16	<i>AO1</i>	REAL	16	0 ... 22.7	mA	2 ms	
02.17	<i>AO2</i>	REAL	16	0 ... 22.7	mA	2 ms	
02.18	<i>AO3</i>	REAL	16	0 ... 22.7	mA	2 ms	
02.19	<i>AO4</i>	REAL	16	0 ... 22.7	mA	2 ms	
02.20	<i>Freq in</i>	REAL	32	0...32767	Hz	250 µs	
02.21	<i>Freq out</i>	REAL	32	0...32767	Hz	250 µs	
02.22	<i>FBA main cw</i>	Pb	32	0x00000000 ... 0xFFFFFFFF	-	500 µs	
02.24	<i>FBA main sw</i>	Pb	32	0x00000000 ... 0xFFFFFFFF	-	-	
02.26	<i>FBA main ref1</i>	INT32	32	-2147483647 ... 2147483647	-	500 µs	
02.27	<i>FBA main ref2</i>	INT32	32	-2147483647 ... 2147483647	-	500 µs	
02.30	<i>D2D main cw</i>	Pb	16	0x0000...0xFFFF	-	500 µs	
02.31	<i>D2D follower cw</i>	Pb	16	0x0000...0xFFFF	-	2 ms	
02.32	<i>D2D ref1</i>	REAL	32	-2147483647 ... 2147483647	-	500 µs	
02.33	<i>D2D ref2</i>	REAL	32	-2147483647 ... 2147483647	-	2 ms	
02.34	<i>Panel ref</i>	REAL	32	-32768...32768	rpm	10 ms	
02.35	<i>FEN DI status</i>	Pb	16	0...0x33	-	500 µs	
03 Control values							
03.03	<i>SpeedRef unramp</i>	REAL	32	-30000...30000	rpm	250 µs	
03.05	<i>SpeedRef ramped</i>	REAL	32	-30000...30000	rpm	250 µs	
03.06	<i>SpeedRef used</i>	REAL	32	-30000...30000	rpm	250 µs	
03.07	<i>Speed error filt</i>	REAL	32	-30000...30000	rpm	250 µs	
03.08	<i>Acc comp torq</i>	REAL	16	-1600...1600	%	250 µs	
03.09	<i>Torq ref sp ctrl</i>	REAL	16	-1600...1600	%	250 µs	
03.11	<i>Torq ref ramped</i>	REAL	16	-1000...1000	%	250 µs	
03.12	<i>Torq ref sp lim</i>	REAL	16	-1000...1000	%	250 µs	
03.13	<i>Torq ref to TC</i>	REAL	16	-1600...1600	%	250 µs	
03.14	<i>Torq ref used</i>	REAL	16	-1600...1600	%	250 µs	
03.15	<i>Brake torq mem</i>	REAL	16	-1000...1000	%	2 ms	
03.16	<i>Brake command</i>	enum	16	0...1	-	2 ms	
03.17	<i>Flux ref used</i>	REAL24	16	0...200	%	2 ms	
03.18	<i>Speed ref pot</i>	REAL	32	-30000...30000	rpm	10 ms	
04 Appl values							
04.01	<i>Process act1</i>	REAL	32	-32768...32768	-	2 ms	
04.02	<i>Process act2</i>	REAL	32	-32768...32768	-	2 ms	
04.03	<i>Process act</i>	REAL	32	-32768...32768	-	2 ms	

242 Additional parameter data

No.	Name	Type	Data length	Range	Unit	Update time	Notes
04.04	<i>Process PID err</i>	REAL	32	-32768...32768	-	2 ms	
04.05	<i>Process PID out</i>	REAL	32	-32768...32768	-	2 ms	
04.06	<i>Process var1</i>	REAL	32	-32768...32768	-	10 ms	
04.07	<i>Process var2</i>	REAL	32	-32768...32768	-	10 ms	
04.08	<i>Process var3</i>	REAL	32	-32768...32768	-	10 ms	
04.09	<i>Counter ontime1</i>	UINT32	32	0...2147483647	s	10 ms	
04.10	<i>Counter ontime2</i>	UINT32	32	0...2147483647	s	10 ms	
04.11	<i>Counter edge1</i>	UINT32	32	0...2147483647	-	10 ms	
04.12	<i>Counter edge2</i>	UINT32	32	0...2147483647	-	10 ms	
04.13	<i>Counter value1</i>	UINT32	32	0...2147483647	-	10 ms	
04.14	<i>Counter value2</i>	UINT32	32	0...2147483647	-	10 ms	
06 Drive status							
06.01	<i>Status word1</i>	Pb	16	0x0000...0xFFFF	-	2 ms	
06.02	<i>Status word2</i>	Pb	16	0x0000...0xFFFF	-	2 ms	
06.03	<i>Speed ctrl stat</i>	Pb	16	0x0000...0xFFFF	-	250 µs	
06.05	<i>Limit word1</i>	Pb	16	0x0000...0xFFFF	-	250 µs	
06.07	<i>Torq lim status</i>	Pb	16	0x0000...0xFFFF	-	250 µs	
06.12	<i>Op mode ack</i>	enum	16	0...11	-	2 ms	
06.13	<i>Superv status</i>	Pb	16	0b00...0b11	-	2 ms	
06.14	<i>Timed func stat</i>	Pb	16	0b0000...0b1111	-	10 ms	
06.15	<i>Counter status</i>	Pb	16	0b000000...0b111111	-	10 ms	
08 Alarms & faults							
08.01	<i>Active fault</i>	enum	16	0...65535	-	-	
08.02	<i>Last fault</i>	enum	16	0...2147483647	-	-	
08.03	<i>Fault time hi</i>	INT32	32	$-2^{31} \dots 2^{31} - 1$	(date)	-	
08.04	<i>Fault time lo</i>	INT32	32	00:00:00 ... 24:00:00	(time)	-	
08.05	<i>Alarm word1</i>	UINT32	16	0x0000...0xFFFF	-	2 ms	
08.06	<i>Alarm word2</i>	UINT32	16	0x0000...0xFFFF	-	2 ms	
08.07	<i>Alarm word3</i>	UINT32	16	0x0000...0xFFFF	-	2 ms	
08.08	<i>Alarm word4</i>	UINT32	16	0x0000...0xFFFF	-	2 ms	
09 System info							
09.01	<i>Drive type</i>	INT32	16	0...65535	-	-	
09.02	<i>Drive rating ID</i>	INT32	16	0...65535	-	-	
09.03	<i>Firmware ID</i>	Pb	16	-	-	-	
09.04	<i>Firmware ver</i>	Pb	16	-	-	-	
09.05	<i>Firmware patch</i>	Pb	16	-	-	-	
09.10	<i>Int logic ver</i>	Pb	32	-	-	-	
09.20	<i>Option slot1</i>	INT32	16	0...21	-	-	
09.21	<i>Option slot2</i>	INT32	16	0...21	-	-	
09.22	<i>Option slot3</i>	INT32	16	0...21	-	-	

Parameter groups 10...99

No.	Name	Type	Data len.	Range	Unit	Default (Factory macro)
10 Start/stop						
10.01	<i>Ext1 start func</i>	enum	16	0...6	-	<i>In1</i>
10.02	<i>Ext1 start in1</i>	Bit pointer	32	-	-	<i>DI1</i>
10.03	<i>Ext1 start in2</i>	Bit pointer	32	-	-	C.FALSE
10.04	<i>Ext2 start func</i>	enum	16	0...6	-	<i>Not sel</i>
10.05	<i>Ext2 start in1</i>	Bit pointer	32	-	-	C.FALSE
10.06	<i>Ext2 start in2</i>	Bit pointer	32	-	-	C.FALSE
10.07	<i>Jog1 start</i>	Bit pointer	32	-	-	C.FALSE
10.08	<i>Jog2 start</i>	Bit pointer	32	-	-	C.FALSE
10.09	<i>Jog enable</i>	Bit pointer	32	-	-	C.FALSE
10.10	<i>Fault reset sel</i>	Bit pointer	32	-	-	<i>DI3</i>
10.11	<i>Run enable</i>	Bit pointer	32	-	-	C.TRUE
10.13	<i>Em stop off3</i>	Bit pointer	32	-	-	C.TRUE
10.15	<i>Em stop off1</i>	Bit pointer	32	-	-	C.TRUE
10.17	<i>Start enable</i>	Bit pointer	32	-	-	C.TRUE
10.19	<i>Start inhibit</i>	enum	16	0...1	-	<i>Disabled</i>
10.20	<i>Start interl func</i>	enum	16	0...1	-	<i>Off2 stop</i>
11 Start/stop mode						
11.01	<i>Start mode</i>	enum	16	0...2	-	<i>Automatic</i>
11.02	<i>Dc-magn time</i>	UINT32	16	0...10000	ms	500 ms
11.03	<i>Stop mode</i>	enum	16	1...2	-	<i>Coast</i>
11.04	<i>Dc hold speed</i>	REAL	16	0...1000	rpm	5.0 rpm
11.05	<i>Dc hold curr ref</i>	UINT32	16	0...100	%	30%
11.06	<i>Dc hold</i>	enum	16	0...1	-	<i>Disabled</i>
11.07	<i>Autophasing mode</i>	enum	16	0...2	-	<i>Turning</i>
12 Operating mode						
12.01	<i>Ext1/Ext2 sel</i>	Bit pointer	32	-	-	C.FALSE
12.03	<i>Ext1 ctrl mode</i>	enum	16	1...5	-	<i>Speed</i>
12.05	<i>Ext2 ctrl mode</i>	enum	16	1...5	-	<i>Speed</i>
13 Analogue inputs						
13.01	<i>AI1 filt time</i>	REAL	16	0...30	s	0.100 s
13.02	<i>AI1 max</i>	REAL	16	-22...22 mA or -11...11 V	mA or V	10.000 V
13.03	<i>AI1 min</i>	REAL	16	-22...22 mA or -11...11 V	mA or V	-10.000 V
13.04	<i>AI1 max scale</i>	REAL	32	-32768...32768	-	1500.000
13.05	<i>AI1 min scale</i>	REAL	32	-32768...32768	-	-1500.000
13.06	<i>AI2 filt time</i>	REAL	16	0...30	s	0.100 s
13.07	<i>AI2 max</i>	REAL	16	-22...22 mA or -11...11 V	mA or V	10.000 V
13.08	<i>AI2 min</i>	REAL	16	-22...22 mA or -11...11 V	mA or V	-10.000 V
13.09	<i>AI2 max scale</i>	REAL	32	-32768...32768	-	100.000

244 Additional parameter data

No.	Name	Type	Data len.	Range	Unit	Default (Factory macro)
13.10	<i>AI2 min scale</i>	REAL	32	-32768...32768	-	-100.000
13.11	<i>AI3 filt time</i>	REAL	16	0...30	s	0.100 s
13.12	<i>AI3 max</i>	REAL	16	-22...22 mA or -11...11 V	mA or V	22.000 mA
13.13	<i>AI3 min</i>	REAL	16	-22...22 mA or -11...11 V	mA or V	4.000 mA
13.14	<i>AI3 max scale</i>	REAL	32	-32768...32768	-	1500.000
13.15	<i>AI3 min scale</i>	REAL	32	-32768...32768	-	0.000
13.16	<i>AI4 filt time</i>	REAL	16	0...30	s	0.100 s
13.17	<i>AI4 max</i>	REAL	16	-22...22 mA or -11...11 V	mA or V	22.000 mA
13.18	<i>AI4 min</i>	REAL	16	-22...22 mA or -11...11 V	mA or V	4.000 mA
13.19	<i>AI4 max scale</i>	REAL	32	-32768...32768	-	1500.000
13.20	<i>AI4 min scale</i>	REAL	32	-32768...32768	-	0.000
13.21	<i>AI5 filt time</i>	REAL	16	0...30	s	0.100 s
13.22	<i>AI5 max</i>	REAL	16	-22...22 mA or -11...11 V	mA or V	22.000 mA
13.23	<i>AI5 min</i>	REAL	16	-22...22 mA or -11...11 V	mA or V	4.000 mA
13.24	<i>AI5 max scale</i>	REAL	32	-32768...32768	-	1500.000
13.25	<i>AI5 min scale</i>	REAL	32	-32768...32768	-	0.000
13.26	<i>AI6 filt time</i>	REAL	16	0...30	s	0.100 s
13.27	<i>AI6 max</i>	REAL	16	-22...22 mA or -11...11 V	mA or V	22.000 mA
13.28	<i>AI6 min</i>	REAL	16	-22...22 mA or -11...11 V	mA or V	4.000 mA
13.29	<i>AI6 max scale</i>	REAL	32	-32768...32768	-	1500.000
13.30	<i>AI6 min scale</i>	REAL	32	-32768...32768	-	0.000
13.31	<i>AI tune</i>	enum	16	0...4	-	<i>No action</i>
13.32	<i>AI superv func</i>	enum	16	0...3	-	<i>No</i>
13.33	<i>AI superv cw</i>	UINT32	32	0b0000...0b1111	-	0b0000
14 Digital I/O						
14.01	<i>DI invert mask</i>	Pb	16	0b00000000 ... 0b11111111	-	0b00000000
14.02	<i>DIO1 conf</i>	enum	16	0...1	-	<i>Output</i>
14.03	<i>DIO1 out src</i>	Bit pointer	32	-	-	<i>Ready relay</i>
14.04	<i>DIO1 Ton</i>	UINT32	16	0...3000	s	0.0 s
14.05	<i>DIO1 Toff</i>	UINT32	16	0...3000	s	0.0 s
14.06	<i>DIO2 conf</i>	enum	16	0...2	-	<i>Output</i>
14.07	<i>DIO2 out src</i>	Bit pointer	32	-	-	<i>RunningRelay</i>
14.08	<i>DIO2 Ton</i>	UINT32	16	0...3000	s	0.0 s
14.09	<i>DIO2 Toff</i>	UINT32	16	0...3000	s	0.0 s
14.10	<i>DIO3 conf</i>	enum	16	0...3	-	<i>Output</i>
14.11	<i>DIO3 out src</i>	Bit pointer	32	-	-	<i>Fault(-1)</i>
14.14	<i>DIO4 conf</i>	enum	16	0...1	-	<i>Output</i>
14.15	<i>DIO4 out src</i>	Bit pointer	32	-	-	<i>Ready relay</i>
14.18	<i>DIO5 conf</i>	enum	16	0...1	-	<i>Output</i>
14.19	<i>DIO5 out src</i>	Bit pointer	32	-	-	<i>Ref running</i>

No.	Name	Type	Data len.	Range	Unit	Default (Factory macro)
14.22	<i>DIO6 conf</i>	enum	16	0...1	-	<i>Output</i>
14.23	<i>DIO6 out src</i>	Bit pointer	32	-	-	<i>Fault</i>
14.26	<i>DIO7 conf</i>	enum	16	0...1	-	<i>Output</i>
14.27	<i>DIO7 out src</i>	Bit pointer	32	-	-	<i>Alarm</i>
14.30	<i>DIO8 conf</i>	enum	16	0...1	-	<i>Output</i>
14.31	<i>DIO8 out src</i>	Bit pointer	32	-	-	<i>Ext2 active</i>
14.34	<i>DIO9 conf</i>	enum	16	0...1	-	<i>Output</i>
14.35	<i>DIO9 out src</i>	Bit pointer	32	-	-	<i>At setpoint</i>
14.38	<i>DIO10 conf</i>	enum	16	0...1	-	<i>Output</i>
14.39	<i>DIO10 out src</i>	Bit pointer	32	-	-	<i>Zero speed</i>
14.42	<i>RO1 src</i>	Bit pointer	32	-	-	<i>Ready relay</i>
14.43	<i>RO1 Ton</i>	UINT32	16	0...3000	s	0.0 s
14.44	<i>RO1 Toff</i>	UINT32	16	0...3000	s	0.0 s
14.45	<i>RO2 src</i>	Bit pointer	32	-	-	<i>RunningRelay</i>
14.48	<i>RO3 src</i>	Bit pointer	32	-	-	<i>Fault(-1)</i>
14.51	<i>RO4 src</i>	Bit pointer	32	-	-	P.06.02.02
14.54	<i>RO5 src</i>	Bit pointer	32	-	-	P.06.02.04
14.57	<i>Freq in max</i>	REAL	16	3...32768	Hz	1000 Hz
14.58	<i>Freq in min</i>	REAL	16	3...32768	Hz	3 Hz
14.59	<i>Freq in max scal</i>	REAL	16	-32768...32768	-	1500
14.60	<i>Freq in min scal</i>	REAL	16	-32768... 32768	-	0
14.61	<i>Freq out src</i>	Val pointer	32	-	-	P.01.01
14.62	<i>Freq out max src</i>	REAL	16	0...32768	-	1500
14.63	<i>Freq out min src</i>	REAL	16	0...32768	-	0
14.64	<i>Freq out max sca</i>	REAL	16	3...32768	Hz	1000 Hz
14.65	<i>Freq out min sca</i>	REAL	16	3...32768	Hz	3 Hz
14.67	<i>RO6 src</i>	Bit pointer	32	-	-	C.FALSE
14.70	<i>RO7 src</i>	Bit pointer	32	-	-	C.FALSE
15 Analogue outputs						
15.01	<i>AO1 src</i>	Val pointer	32	-	-	<i>Current %</i>
15.02	<i>AO1 filt time</i>	REAL	16	0...30	s	0.100 s
15.03	<i>AO1 out max</i>	REAL	16	0 ... 22.7	mA	20.000 mA
15.04	<i>AO1 out min</i>	REAL	16	0 ... 22.7	mA	4.000 mA
15.05	<i>AO1 src max</i>	REAL	32	-32768...32768	-	100.000
15.06	<i>AO1 src min</i>	REAL	32	-32768...32768	-	0.000
15.07	<i>AO2 src</i>	Val pointer	32	-	-	<i>Speed %</i>
15.08	<i>AO2 filt time</i>	REAL	16	0...30	s	0.100 s
15.09	<i>AO2 out max</i>	REAL	16	0 ... 22.7	mA	20.000 mA
15.10	<i>AO2 out min</i>	REAL	16	0 ... 22.7	mA	4.000 mA
15.11	<i>AO2 src max</i>	REAL	32	-32768...32768	-	100.000

246 Additional parameter data

No.	Name	Type	Data len.	Range	Unit	Default (Factory macro)
15.12	<i>AO2 src min</i>	REAL	32	-32768...32768	-	-100.000
15.13	<i>AO3 src</i>	Val pointer	32	-	-	<i>Frequency</i>
15.14	<i>AO3 filt time</i>	REAL	16	0...30	s	0.100 s
15.15	<i>AO3 out max</i>	REAL	16	0 ... 22.7	mA	22.000 mA
15.16	<i>AO3 out min</i>	REAL	16	0 ... 22.7	mA	4.000 mA
15.17	<i>AO3 src max</i>	REAL	32	-32768...32768	-	50.000
15.18	<i>AO3 src min</i>	REAL	32	-32768...32768	-	0.000
15.19	<i>AO4 src</i>	Val pointer	32	-	-	<i>Frequency</i>
15.20	<i>AO4 filt time</i>	REAL	16	0...30	s	0.100 s
15.21	<i>AO4 out max</i>	REAL	16	0 ... 22.7	mA	22.000 mA
15.22	<i>AO4 out min</i>	REAL	16	0 ... 22.7	mA	4.000 mA
15.23	<i>AO4 src max</i>	REAL	32	-32768...32768	-	50.000
15.24	<i>AO4 src min</i>	REAL	32	-32768...32768	-	0.000
15.25	<i>AO ctrl word</i>	UINT32	32	0b0000...0b1111	-	0b0000
16 System						
16.01	<i>Local lock</i>	Bit pointer	32	-	-	C.FALSE
16.02	<i>Parameter lock</i>	enum	16	0...2	-	<i>Open</i>
16.03	<i>Pass code</i>	INT32	32	0...2147483647	-	0
16.04	<i>Param restore</i>	enum	16	0...2	-	<i>Done</i>
16.07	<i>Param save</i>	enum	16	0...1	-	<i>Done</i>
16.09	<i>User set sel</i>	enum	32	1...10	-	<i>No request</i>
16.10	<i>User set log</i>	Pb	32	0...1024	-	<i>N/A</i>
16.11	<i>User IO sel lo</i>	Bit pointer	32	-	-	C.FALSE
16.12	<i>User IO sel hi</i>	Bit pointer	32	-	-	C.FALSE
16.14	<i>Reset ChgParLog</i>	enum	16	0...1	-	<i>Done</i>
16.15	<i>Menu set sel</i>	enum	16	0...2	-	<i>No request</i>
16.16	<i>Menu set active</i>	enum	16	0...2	-	<i>Short menu</i>
16.17	<i>Power unit</i>	enum	16	0...1	-	<i>kW</i>
19 Speed calculation						
19.01	<i>Speed scaling</i>	REAL	16	0...30000	rpm	1500 rpm
19.02	<i>Speed fb sel</i>	enum	16	0...2	-	<i>Estimated</i>
19.03	<i>MotorSpeed filt</i>	REAL	32	0...10000	ms	8.000 ms
19.06	<i>Zero speed limit</i>	REAL	32	0...30000	rpm	30.00 rpm
19.07	<i>Zero speed delay</i>	UINT32	16	0...30000	ms	0 ms
19.08	<i>Above speed lim</i>	REAL	16	0...30000	rpm	0 rpm
19.09	<i>Speed TripMargin</i>	REAL	32	0...10000	rpm	500.0 rpm
19.10	<i>Speed window</i>	REAL	16	0...30000	rpm	100 rpm
20 Limits						
20.01	<i>Maximum speed</i>	REAL	32	0...30000	rpm	1500 rpm
20.02	<i>Minimum speed</i>	REAL	32	-30000...0	rpm	-1500 rpm

No.	Name	Type	Data len.	Range	Unit	Default (Factory macro)
20.03	<i>Pos speed ena</i>	Bit pointer	32	-	-	C.TRUE
20.04	<i>Neg speed ena</i>	Bit pointer	32	-	-	C.TRUE
20.05	<i>Maximum current</i>	REAL	32	0...30000	A	0.00 A
20.06	<i>Torq lim sel</i>	Bit pointer	32	-	-	C.FALSE
20.07	<i>Maximum torque1</i>	REAL	16	0...1600	%	300.0%
20.08	<i>Minimum torque1</i>	REAL	16	-1600...0	%	-300.0%
20.09	<i>Maximum torque2</i>	REAL	16	-	-	<i>Max torque1</i>
20.10	<i>Minimum torque2</i>	REAL	16	-	-	<i>Min torque1</i>
20.12	<i>P motoring lim</i>	REAL	16	0...1600	%	300.0%
20.13	<i>P generating lim</i>	REAL	16	0...1600	%	300.0%
21 Speed ref						
21.01	<i>Speed ref1 sel</i>	Val pointer	32	-	-	<i>A11 scaled</i>
21.02	<i>Speed ref2 sel</i>	Val pointer	32	-	-	<i>Zero</i>
21.03	<i>Speed ref1 func</i>	enum	16	0...5	-	<i>Ref1</i>
21.04	<i>Speed ref1/2 sel</i>	Bit pointer	32	-	-	C.FALSE
21.05	<i>Speed share</i>	REAL	16	-8...8	-	1.000
21.07	<i>Speed ref jog1</i>	REAL	16	-30000...30000	rpm	0 rpm
21.08	<i>Speed ref jog2</i>	REAL	16	-30000...30000	rpm	0 rpm
21.09	<i>SpeedRef min abs</i>	REAL	16	0...30000	rpm	0 rpm
21.10	<i>Mot pot func</i>	enum	16	0...1	-	<i>Reset</i>
21.11	<i>Mot pot up</i>	Bit pointer	32	-	-	<i>DI5</i>
21.12	<i>Mot pot down</i>	Bit pointer	32	-	-	<i>DI6</i>
22 Speed ref ramp						
22.01	<i>Acc/Dec sel</i>	Bit pointer	32	-	-	C.FALSE
22.02	<i>Acc time1</i>	REAL	32	0...1800	s	20.000 s
22.03	<i>Dec time1</i>	REAL	32	0...1800	s	20.000 s
22.04	<i>Acc time2</i>	REAL	32	0...1800	s	60.000 s
22.05	<i>Dec time2</i>	REAL	32	0...1800	s	60.000 s
22.06	<i>Shape time acc1</i>	REAL	32	0...1000	s	0.100 s
22.07	<i>Shape time acc2</i>	REAL	32	0...1000	s	0.100 s
22.08	<i>Shape time dec1</i>	REAL	32	0...1000	s	0.100 s
22.09	<i>Shape time dec2</i>	REAL	32	0...1000	s	0.100 s
22.10	<i>Acc time jogging</i>	REAL	32	0...1800	s	0.000 s
22.11	<i>Dec time jogging</i>	REAL	32	0...1800	s	0.000 s
22.12	<i>Em stop time</i>	REAL	32	0...1800	s	3.000 s
23 Speed ctrl						
23.01	<i>Proport gain</i>	REAL	16	0...200	-	10.00
23.02	<i>Integration time</i>	REAL	32	0...600	s	0.500 s
23.03	<i>Derivation time</i>	REAL	16	0...10	s	0.000 s
23.04	<i>Deriv filt time</i>	REAL	16	0...1000	ms	8.0 ms

248 Additional parameter data

No.	Name	Type	Data len.	Range	Unit	Default (Factory macro)
23.05	<i>Acc comp DerTime</i>	REAL	32	0...600	s	0.00 s
23.06	<i>Acc comp Ftime</i>	REAL	16	0...1000	ms	8.0 ms
23.07	<i>Speed err Ftime</i>	REAL	16	0...1000	ms	0.0 ms
23.08	<i>Speed additive</i>	Val pointer	32	-	-	<i>Zero</i>
23.09	<i>Max torq sp ctrl</i>	REAL	16	-1600...1600	%	300.0%
23.10	<i>Min torq sp ctrl</i>	REAL	16	-1600...1600	%	-300.0%
23.11	<i>SpeedErr winFunc</i>	enum	16	0...2	-	<i>Disabled</i>
23.12	<i>SpeedErr win hi</i>	REAL	16	0...3000	rpm	0 rpm
23.13	<i>SpeedErr win lo</i>	REAL	16	0...3000	rpm	0 rpm
23.14	<i>Drooping rate</i>	REAL	16	0...100	%	0.00%
23.15	<i>PI adapt max sp</i>	REAL	16	0...30000	rpm	0 rpm
23.16	<i>PI adapt min sp</i>	REAL	16	0...30000	rpm	0 rpm
23.17	<i>Pcoef at min sp</i>	REAL	16	0...10	-	1.000
23.18	<i>Icoef at min sp</i>	REAL	16	0...10	-	1.000
23.20	<i>PI tune mode</i>	enum	16	0...4	-	<i>Done</i>
23.21	<i>Tune bandwidth</i>	REAL	16	0...2000	Hz	100.00 Hz
23.22	<i>Tune damping</i>	REAL	16	0...200	-	1.5
24 Torque ref						
24.01	<i>Torq ref1 sel</i>	Val pointer	32	-	-	<i>AI2 scaled</i>
24.02	<i>Torq ref add sel</i>	Val pointer	32	-	-	<i>Zero</i>
24.03	<i>Maximum torq ref</i>	REAL	16	0...1000	%	300.0%
24.04	<i>Minimum torq ref</i>	REAL	16	-1000...0	%	-300.0%
24.05	<i>Load share</i>	REAL	16	-8...8	-	1.000
24.06	<i>Torq ramp up</i>	UINT32	32	0...60	s	0.000 s
24.07	<i>Torq ramp down</i>	UINT32	32	0...60	s	0.000 s
25 Critical speed						
25.01	<i>Crit speed sel</i>	enum	16	0...1	-	<i>Disable</i>
25.02	<i>Crit speed1 lo</i>	REAL	16	-30000...30000	rpm	0 rpm
25.03	<i>Crit speed1 hi</i>	REAL	16	-30000...30000	rpm	0 rpm
25.04	<i>Crit speed2 lo</i>	REAL	16	-30000...30000	rpm	0 rpm
25.05	<i>Crit speed2 hi</i>	REAL	16	-30000...30000	rpm	0 rpm
25.06	<i>Crit speed3 lo</i>	REAL	16	-30000...30000	rpm	0 rpm
25.07	<i>Crit speed3 hi</i>	REAL	16	-30000...30000	rpm	0 rpm
26 Constant speeds						
26.01	<i>Const speed func</i>	Pb	16	0b00...0b11	-	0b00
26.02	<i>Const speed sel1</i>	Bit pointer	32	-	-	C.FALSE
26.03	<i>Const speed sel2</i>	Bit pointer	32	-	-	C.FALSE
26.04	<i>Const speed sel3</i>	Bit pointer	32	-	-	C.FALSE
26.06	<i>Const speed1</i>	REAL	16	-30000...30000	rpm	0 rpm
26.07	<i>Const speed2</i>	REAL	16	-30000...30000	rpm	0 rpm

No.	Name	Type	Data len.	Range	Unit	Default (Factory macro)
26.08	Const speed3	REAL	16	-30000...30000	rpm	0 rpm
26.09	Const speed4	REAL	16	-30000...30000	rpm	0 rpm
26.10	Const speed5	REAL	16	-30000...30000	rpm	0 rpm
26.11	Const speed6	REAL	16	-30000...30000	rpm	0 rpm
26.12	Const speed7	REAL	16	-30000...30000	rpm	0 rpm
27 Process PID						
27.01	PID setpoint sel	Val pointer	32	-	-	A1 scaled
27.02	PID fbk func	enum	16	0...8	-	Act1
27.03	PID fbk1 src	Val pointer	32	-	-	A12 scaled
27.04	PID fbk2 src	Val pointer	32	-	-	A12 scaled
27.05	PID fbk1 max	REAL	32	-32768...32768	-	100.00
27.06	PID fbk1 min	REAL	32	-32768...32768	-	-100.00
27.07	PID fbk2 max	REAL	32	-32768...32768	-	100.00
27.08	PID fbk2 min	REAL	32	-32768...32768	-	-100.00
27.09	PID fbk gain	REAL	16	-32.768 ... 32.767	-	1.000
27.10	PID fbk ftime	REAL	16	0...30	s	0.040 s
27.12	PID gain	REAL	16	0...100	-	1.00
27.13	PID integ time	REAL	16	0...320	s	60.00 s
27.14	PID deriv time	REAL	16	0...10	s	0.00 s
27.15	PID deriv filter	REAL	16	0...10	s	1.00 s
27.16	PID error inv	Bit pointer	32	-	-	C.FALSE
27.17	PID mode	enum	16	0...2	-	Direct
27.18	PID maximum	REAL	32	-32768...32768	-	100.0
27.19	PID minimum	REAL	32	-32768...32768	-	-100.0
27.22	Sleep mode	enum	16	0...2	-	No
27.23	Sleep level	REAL	32	-32768...32768	-	0.0
27.24	Sleep delay	UINT32	32	0...360	s	0.0 s
27.25	Wake up level	REAL	32	0...32768	-	0.0
27.26	Wake up delay	UINT32	32	0...360	s	0.0 s
27.27	Sleep ena	Bit pointer	32	-	-	C.FALSE
30 Fault functions						
30.01	External fault	Bit pointer	32	-	-	C.TRUE
30.02	Speed ref safe	REAL	16	-30000...30000	rpm	0 rpm
30.03	Local ctrl loss	enum	16	0...3	-	Fault
30.04	Mot phase loss	enum	16	0...1	-	Fault
30.05	Earth fault	enum	16	0...2	-	Fault
30.06	Suppl phs loss	enum	16	0...1	-	Fault
30.07	Sto diagnostic	enum	16	1...3	-	Fault
30.08	Cross connection	enum	16	0...1	-	Fault
30.09	Stall function	Pb	16	0b000...0b111	-	0b111

250 Additional parameter data

No.	Name	Type	Data len.	Range	Unit	Default (Factory macro)
30.10	<i>Stall curr lim</i>	REAL	16	0...1600	%	300.0%
30.11	<i>Stall freq hi</i>	REAL	16	0.5 ... 1000	Hz	20.0 Hz
30.12	<i>Stall time</i>	UINT32	16	0...3600	s	20 s
31 Mot therm prot						
31.01	<i>Mot temp1 prot</i>	enum	16	0...2	-	<i>No</i>
31.02	<i>Mot temp1 src</i>	enum	16	0...12	-	<i>Estimated</i>
31.03	<i>Mot temp1 almLim</i>	INT32	16	0...200	°C	90 °C
31.04	<i>Mot temp1 fltLim</i>	INT32	16	0...200	°C	110 °C
31.05	<i>Mot temp2 prot</i>	enum	16	0...2	-	<i>No</i>
31.06	<i>Mot temp2 src</i>	enum	16	0...12	-	<i>Estimated</i>
31.07	<i>Mot temp2 almLim</i>	INT32	16	0...200	°C	90 °C
31.08	<i>Mot temp2 fltLim</i>	INT32	16	0...200	°C	110 °C
31.09	<i>Mot ambient temp</i>	INT32	16	-60...100	°C	20 °C
31.10	<i>Mot load curve</i>	INT32	16	50...150	%	100%
31.11	<i>Zero speed load</i>	INT32	16	50...150	%	100%
31.12	<i>Break point</i>	INT32	16	0.01...500	Hz	45.00 Hz
31.13	<i>Mot nom tempRise</i>	INT32	16	0...300	°C	80 °C
31.14	<i>Mot therm time</i>	INT32	16	100...10000	s	256 s
32 Automatic reset						
32.01	<i>Autoreset sel</i>	Pb	16	0b000000...0b111111	-	0b000000
32.02	<i>Number of trials</i>	UINT32	16	0...5	-	0
32.03	<i>Trial time</i>	UINT32	16	1...600	s	30.0 s
32.04	<i>Delay time</i>	UINT32	16	0...120	s	0.0 s
33 Supervision						
33.01	<i>Superv1 func</i>	enum	16	0...4	-	<i>Disabled</i>
33.02	<i>Superv1 act</i>	Val pointer	32	-	-	<i>Speed rpm</i>
33.03	<i>Superv1 hi</i>	REAL	32	-32768...32768	-	0.00
33.04	<i>Superv1 lo</i>	REAL	32	-32768...32768	-	0.00
33.05	<i>Superv2 func</i>	enum	16	0...4	-	<i>Disabled</i>
33.06	<i>Superv2 act</i>	Val pointer	32	-	-	<i>Current</i>
33.07	<i>Superv2 hi</i>	REAL	32	-32768...32768	-	0.00
33.08	<i>Superv2 lo</i>	REAL	32	-32768...32768	-	0.00
33.09	<i>Superv3 func</i>	enum	16	0...4	-	<i>Disabled</i>
33.10	<i>Superv3 act</i>	Val pointer	32	-	-	<i>Torque</i>
33.11	<i>Superv3 hi</i>	REAL	32	-32768...32768	-	0.00
33.12	<i>Superv3 lo</i>	REAL	32	-32768...32768	-	0.00
34 User load curve						
34.01	<i>Overload func</i>	Pb	16	0b000000...0b111111	-	0b000000
34.02	<i>Underload func</i>	Pb	16	0b0000...0b1111	-	0b0000
34.03	<i>Load freq1</i>	REAL	16	1...500	Hz	5 Hz

No.	Name	Type	Data len.	Range	Unit	Default (Factory macro)
34.04	<i>Load freq2</i>	REAL	16	1...500	Hz	25 Hz
34.05	<i>Load freq3</i>	REAL	16	1...500	Hz	43 Hz
34.06	<i>Load freq4</i>	REAL	16	1...500	Hz	50 Hz
34.07	<i>Load freq5</i>	REAL	16	1...500	Hz	500 Hz
34.08	<i>Load low lim1</i>	REAL	16	0...1600	%	10%
34.09	<i>Load low lim2</i>	REAL	16	0...1600	%	15%
34.10	<i>Load low lim3</i>	REAL	16	0...1600	%	25%
34.11	<i>Load low lim4</i>	REAL	16	0...1600	%	30%
34.12	<i>Load low lim5</i>	REAL	16	0...1600	%	30%
34.13	<i>Load high lim1</i>	REAL	16	0...1600	%	300%
34.14	<i>Load high lim2</i>	REAL	16	0...1600	%	300%
34.15	<i>Load high lim3</i>	REAL	16	0...1600	%	300%
34.16	<i>Load high lim4</i>	REAL	16	0...1600	%	300%
34.17	<i>Load high lim5</i>	REAL	16	0...1600	%	300%
34.18	<i>Load integ time</i>	UINT32	16	0...10000	s	100 s
34.19	<i>Load cool time</i>	UINT32	16	0...10000	s	20 s
34.20	<i>Underload time</i>	UINT32	16	0...10000	s	10 s
35 Process variable						
35.01	<i>Signal1 param</i>	Val pointer	32	-	-	<i>Speed %</i>
35.02	<i>Signal1 max</i>	REAL	32	-32768...32768	-	300.000
35.03	<i>Signal1 min</i>	REAL	32	-32768...32768	-	-300.000
35.04	<i>Proc var1 dispf</i>	enum	16	0...5	-	3
35.05	<i>Proc var1 unit</i>	enum	16	0...98	-	4
35.06	<i>Proc var1 max</i>	REAL	32	-32768...32768	-	300.000
35.07	<i>Proc var1 min</i>	REAL	32	-32768...32768	-	-300.000
35.08	<i>Signal2 param</i>	Val pointer	32	-	-	<i>Current %</i>
35.09	<i>Signal2 max</i>	REAL	32	-32768...32768	-	300.000
35.10	<i>Signal2 min</i>	REAL	32	-32768...32768	-	-300.000
35.11	<i>Proc var2 dispf</i>	enum	16	0...5	-	3
35.12	<i>Proc var2 unit</i>	enum	16	0...98	-	4
35.13	<i>Proc var2 max</i>	REAL	32	-32768...32768	-	300.000
35.14	<i>Proc var2 min</i>	REAL	32	-32768...32768	-	-300.000
35.15	<i>Signal3 param</i>	Val pointer	32	-	-	<i>Torque</i>
35.16	<i>Signal3 max</i>	REAL	32	-32768...32768	-	300.000
35.17	<i>Signal3 min</i>	REAL	32	-32768...32768	-	-300.000
35.18	<i>Proc var3 dispf</i>	enum	16	0...5	-	3
35.19	<i>Proc var3 unit</i>	enum	16	0...98	-	4
35.20	<i>Proc var3 max</i>	REAL	32	-32768...32768	-	300.000
35.21	<i>Proc var3 min</i>	REAL	32	-32768...32768	-	-300.000

252 Additional parameter data

No.	Name	Type	Data len.	Range	Unit	Default (Factory macro)
36 Timed functions						
36.01	<i>Timers enable</i>	Bit pointer	32	-	-	C.FALSE
36.02	<i>Timers mode</i>	Pb	16	0b0000...0b1111	-	0b0000
36.03	<i>Start time1</i>	UINT32	32	00:00:00 ... 24:00:00	-	00:00:00
36.04	<i>Stop time1</i>	UINT32	32	00:00:00 ... 24:00:00	-	00:00:00
36.05	<i>Start day1</i>	enum	16	1...7	-	<i>Monday</i>
36.06	<i>Stop day1</i>	enum	16	1...7	-	<i>Monday</i>
36.07	<i>Start time2</i>	UINT32	32	00:00:00 ... 24:00:00	-	00:00:00
36.08	<i>Stop time2</i>	UINT32	32	00:00:00 ... 24:00:00	-	00:00:00
36.09	<i>Start day2</i>	enum	16	1...7	-	<i>Monday</i>
36.10	<i>Stop day2</i>	enum	16	1...7	-	<i>Monday</i>
36.11	<i>Start time3</i>	UINT32	32	00:00:00 ... 24:00:00	-	00:00:00
36.12	<i>Stop time3</i>	UINT32	32	00:00:00 ... 24:00:00	-	00:00:00
36.13	<i>Start day3</i>	enum	16	1...7	-	<i>Monday</i>
36.14	<i>Stop day3</i>	enum	16	1...7	-	<i>Monday</i>
36.15	<i>Start time4</i>	UINT32	32	00:00:00 ... 24:00:00	-	00:00:00
36.16	<i>Stop time4</i>	UINT32	32	00:00:00 ... 24:00:00	-	00:00:00
36.17	<i>Start day4</i>	enum	16	1...7	-	<i>Monday</i>
36.18	<i>Stop day4</i>	enum	16	1...7	-	<i>Monday</i>
36.19	<i>Boost signal</i>	Bit pointer	32	-	-	C.FALSE
36.20	<i>Boost time</i>	UINT32	32	00:00:00 ... 24:00:00	-	00:00:00
36.21	<i>Timed func1</i>	Pb	16	0b00000...0b11111	-	0b00000
36.22	<i>Timed func2</i>	Pb	16	0b00000...0b11111	-	0b00000
36.23	<i>Timed func3</i>	Pb	16	0b00000...0b11111	-	0b00000
36.24	<i>Timed func4</i>	Pb	16	0b00000...0b11111	-	0b00000
38 Flux ref						
38.01	<i>Flux ref</i>	REAL	16	0...200	%	100%
38.03	<i>U/f curve func</i>	enum	16	0...2	-	<i>Linear</i>
38.04	<i>U/f curve freq1</i>	REAL	16	1...500	%	10%
38.05	<i>U/f curve freq2</i>	REAL	16	1...500	%	30%
38.06	<i>U/f curve freq3</i>	REAL	16	1...500	%	50%
38.07	<i>U/f curve freq4</i>	REAL	16	1...500	%	70%
38.08	<i>U/f curve freq5</i>	REAL	16	1...500	%	90%
38.09	<i>U/f curve volt1</i>	REAL	16	0...200	%	20%
38.10	<i>U/f curve volt2</i>	REAL	16	0...200	%	40%
38.11	<i>U/f curve volt3</i>	REAL	16	0...200	%	60%
38.12	<i>U/f curve volt4</i>	REAL	16	0...200	%	80%
38.13	<i>U/f curve volt5</i>	REAL	16	0...200	%	100%
40 Motor control						
40.01	<i>Motor noise</i>	enum	16	0...2	-	<i>Cyclic</i>

No.	Name	Type	Data len.	Range	Unit	Default (Factory macro)
40.03	<i>Slip gain</i>	REAL24	32	0...200	%	100%
40.04	<i>Voltage reserve</i>	REAL24	32	-4...50	%	-1%
40.06	<i>Force open loop</i>	enum	16	0...1	-	<i>False</i>
40.07	<i>IR-compensation</i>	REAL24	32	0...50	%	0.00%
42 Mech brake ctrl						
42.01	<i>Brake ctrl</i>	enum	16	0...2	-	<i>No</i>
42.02	<i>Brake acknowl</i>	Bit pointer	32	-	-	C.FALSE
42.03	<i>Open delay</i>	UINT32	16	0...5	s	0.00 s
42.04	<i>Close delay</i>	UINT32	16	0...60	s	0.00 s
42.05	<i>Close speed</i>	REAL	16	0...1000	rpm	100.0 rpm
42.06	<i>Close cmd delay</i>	UINT32	16	0...10	s	0.00 s
42.07	<i>Reopen delay</i>	UINT32	16	0...10	s	0.00 s
42.08	<i>Brake open torq</i>	REAL	16	-1000...1000	%	0.0%
42.09	<i>Open torq src</i>	Val pointer	32	-	-	<i>P.42.08</i>
42.10	<i>Brake close req</i>	Bit pointer	32	-	-	C.FALSE
42.11	<i>Brake hold open</i>	Bit pointer	32	-	-	C.FALSE
42.12	<i>Brake fault func</i>	enum	16	0...2	-	<i>Fault</i>
42.13	<i>Close flt delay</i>	UINT32	16	0...60	s	0.00 s
44 Maintenance						
44.01	<i>Ontime1 func</i>	Pb	16	0b00...0b11	-	0b01
44.02	<i>Ontime1 src</i>	Bit pointer	32	-	-	<i>Running</i>
44.03	<i>Ontime1 limit</i>	UINT32	32	0...2147483647	s	36000000 s
44.04	<i>Ontime1 alm sel</i>	enum	16	0...6	-	<i>Mot bearing</i>
44.05	<i>Ontime2 func</i>	Pb	16	0b00...0b11	-	0b01
44.06	<i>Ontime2 src</i>	Bit pointer	32	-	-	<i>Charged</i>
44.07	<i>Ontime2 limit</i>	UINT32	32	0...2147483647	s	15768000 s
44.08	<i>Ontime2 alm sel</i>	enum	16	0...6	-	<i>Device clean</i>
44.09	<i>Edge count1 func</i>	Pb	16	0b00...0b11	-	0b01
44.10	<i>Edge count1 src</i>	Bit pointer	32	-	-	<i>Charged</i>
44.11	<i>Edge count1 lim</i>	UINT32	32	0...2147483647	-	5000
44.12	<i>Edge count1 div</i>	UINT32	32	0...2147483647	-	1
44.13	<i>Edg cnt1 alm sel</i>	enum	16	0...5	-	<i>Dc-charge</i>
44.14	<i>Edge count2 func</i>	Pb	16	0b00...0b11	-	0b01
44.15	<i>Edge count2 src</i>	Bit pointer	32	-	-	<i>RO1</i>
44.16	<i>Edge count2 lim</i>	UINT32	32	0...2147483647	-	10000
44.17	<i>Edge count2 div</i>	UINT32	32	0...2147483647	-	1
44.18	<i>Edg cnt2 alm sel</i>	enum	16	0...5	-	<i>Output relay</i>
44.19	<i>Val count1 func</i>	Pb	16	0b00...0b11	-	0b01
44.20	<i>Val count1 src</i>	Val pointer	32	-	-	<i>Speed rpm</i>
44.21	<i>Val count1 lim</i>	UINT32	32	0...2147483647	-	13140000

254 Additional parameter data

No.	Name	Type	Data len.	Range	Unit	Default (Factory macro)
44.22	<i>Val count1 div</i>	UINT32	32	0...2147483647	-	60
44.23	<i>Val cnt1 alm sel</i>	enum	16	0...1	-	<i>Mot bearing</i>
44.24	<i>Val count2 func</i>	Pb	16	0b00...0b11	-	0b01
44.25	<i>Val count2 src</i>	Val pointer	32	-	-	<i>Speed rpm</i>
44.26	<i>Val count2 lim</i>	UINT32	32	0...2147483647	-	6570000
44.27	<i>Val count2 div</i>	UINT32	32	0...2147483647	-	60
44.28	<i>Val cnt2 alm sel</i>	enum	16	0...1	-	<i>Value2</i>
44.29	<i>Fan ontime lim</i>	UINT32	32	0...35791394.1	h	0.00 h
44.30	<i>Runtime lim</i>	UINT32	32	0...35791394.1	h	0.00 h
44.31	<i>Runtime alm sel</i>	enum	16	1...5	-	<i>Device clean</i>
44.32	<i>kWh inv lim</i>	UINT32	32	0...2147483647	kWh	0 kWh
44.33	<i>kWh inv alm sel</i>	enum	16	1...5	-	<i>Device clean</i>
45 Energy optimising						
45.01	<i>Energy optim</i>	enum	16	0...1	-	<i>Disable</i>
45.02	<i>Energy tariff1</i>	UINT32	32	0...21474836.47	-	0.65
45.06	<i>E tariff unit</i>	enum	16	0...2	-	0
45.08	<i>Pump ref power</i>	REAL	16	0...1000	%	100.0%
45.09	<i>Energy reset</i>	enum	16	0...1	-	<i>Done</i>
47 Voltage ctrl						
47.01	<i>Overvolt ctrl</i>	enum	16	0...1	-	<i>Enable</i>
47.02	<i>Undervolt ctrl</i>	enum	16	0...1	-	<i>Enable</i>
47.03	<i>SupplyVoltAutold</i>	enum	16	0...1	-	<i>Enable</i>
47.04	<i>Supply voltage</i>	REAL	16	0...1000.0	V	400.0 V
48 Brake chopper						
48.01	<i>Bc enable</i>	enum	16	0...2	-	<i>Disable</i>
48.02	<i>Bc run-time ena</i>	Bit pointer	32	-	-	C.TRUE
48.03	<i>BrThermTimeConst</i>	REAL24	32	0...10000	s	0 s
48.04	<i>Br power max cnt</i>	REAL24	32	0...10000	kW	0.0000 kW
48.05	<i>R br</i>	REAL24	32	0.1...1000	ohm	0.0000 Ohm
48.06	<i>Br temp faultlim</i>	REAL24	16	0...150	%	105%
48.07	<i>Br temp alarmlim</i>	REAL24	16	0...150	%	95%
49 Data storage						
49.01	<i>Data storage1</i>	UINT32	16	-32768...32768	-	0
49.02	<i>Data storage2</i>	UINT32	16	-32768...32768	-	0
49.03	<i>Data storage3</i>	UINT32	16	-32768...32768	-	0
49.04	<i>Data storage4</i>	UINT32	16	-32768...32768	-	0
49.05	<i>Data storage5</i>	UINT32	32	-2147483647 ... 2147483647	-	0
49.06	<i>Data storage6</i>	UINT32	32	-2147483647 ... 2147483647	-	0
49.07	<i>Data storage7</i>	UINT32	32	-2147483647 ... 2147483647	-	0
49.08	<i>Data storage8</i>	UINT32	32	-2147483647 ... 2147483647	-	0

No.	Name	Type	Data len.	Range	Unit	Default (Factory macro)
50 Fieldbus						
50.01	<i>Fba enable</i>	enum	16	0...1	-	<i>Disable</i>
50.02	<i>Comm loss func</i>	enum	16	0...3	-	<i>No</i>
50.03	<i>Comm loss t out</i>	UINT32	16	0.3...6553.5	s	0.3 s
50.04	<i>Fba ref1 modesel</i>	enum	16	0...2	-	<i>Speed</i>
50.05	<i>Fba ref2 modesel</i>	enum	16	0...2	-	<i>Torque</i>
50.06	<i>Fba act1 tr src</i>	Val pointer	32	-	-	P.01.01
50.07	<i>Fba act2 tr src</i>	Val pointer	32	-	-	P.01.06
50.08	<i>Fba sw b12 src</i>	Bit pointer	32	-	-	C.FALSE
50.09	<i>Fba sw b13 src</i>	Bit pointer	32	-	-	C.FALSE
50.10	<i>Fba sw b14 src</i>	Bit pointer	32	-	-	C.FALSE
50.11	<i>Fba sw b15 src</i>	Bit pointer	32	-	-	C.FALSE
51 FBA settings						
51.01	<i>FBA type</i>	UINT32	16	0...65536	-	0
51.02	<i>FBA par2</i>	UINT32	16	0...65536	-	0
...
51.26	<i>FBA par26</i>	UINT32	16	0...65536	-	0
51.27	<i>FBA par refresh</i>	enum	16	0...1	-	<i>Done</i>
51.28	<i>Par table ver</i>	UINT32	16	0...65536	-	-
51.29	<i>Drive type code</i>	UINT32	16	0...65536	-	-
51.30	<i>Mapping file ver</i>	UINT32	16	0...65536	-	-
51.31	<i>D2FBA comm sta</i>	enum	16	0...6	-	<i>Idle</i>
51.32	<i>FBA comm sw ver</i>	UINT32	16	0...65536	-	-
51.33	<i>FBA appl sw ver</i>	UINT32	16	0...65536	-	-
52 FBA data in						
52.01	<i>FBA data in1</i>	UINT32	16	0...9999	-	0
...
52.12	<i>FBA data in12</i>	UINT32	16	0...9999	-	0
53 FBA data out						
53.01	<i>FBA data out1</i>	UINT32	16	0...9999	-	0
...
53.12	<i>FBA data out12</i>	UINT32	16	0...9999	-	0
56 Panel display						
56.01	<i>Signal1 param</i>	UINT32		00.00 ... 255.255	-	01.03
56.02	<i>Signal2 param</i>	UINT32		00.00 ... 255.255	-	01.04
56.03	<i>Signal3 param</i>	UINT32		00.00 ... 255.255	-	01.06
56.04	<i>Signal1 mode</i>	INT32		-1...3	-	<i>Normal</i>
56.05	<i>Signal2 mode</i>	INT32		-1...3	-	<i>Normal</i>
56.06	<i>Signal3 mode</i>	INT32		-1...3	-	<i>Normal</i>

No.	Name	Type	Data len.	Range	Unit	Default (Factory macro)
57 D2D communication						
57.01	Link mode	enum	16	0...2	-	Disabled
57.02	Comm loss func	enum	16	0...2	-	Alarm
57.03	Node address	UINT32	16	1...62	-	1
57.04	Follower mask 1	UINT32	32	0h00000000 ... 0h7FFFFFFF	-	0h00000000
57.05	Follower mask 2	UINT32	32	0h00000000 ... 0h7FFFFFFF	-	0h00000000
57.06	Ref 1 src	Val pointer	32	-	-	P.03.05
57.07	Ref 2 src	Val pointer	32	-	-	P.03.13
57.08	Follower cw src	Val pointer	32	-	-	P.02.31
57.11	Ref1 msg type	enum	16	0...1	-	Broadcast
57.12	Ref1 mc group	UINT32	16	0...62	-	0
57.13	Next ref1 mc grp	UINT32	16	0...62	-	0
57.14	Nr ref1 mc grps	UINT32	16	1...62	-	1
57.15	D2D com port	enum	16	0...3	-	on-board
64 Load analyzer						
64.01	PVL signal	Val pointer	32	-	-	Power inu
64.02	PVL filt time	REAL	16	0...120	s	2.00 s
64.03	Reset loggers	Bit pointer	32	-	-	C.FALSE
64.04	AL signal	Val pointer	32	-	-	Power motor
64.05	AL signal base	REAL	32	0...32768	-	100.00
64.06	PVL peak value1	REAL	32	-32768...32768	-	-
64.07	Date of peak	UINT32	32	01.01.80...	d	-
64.08	Time of peak	UINT32	32	00:00:00...23:59:59	s	-
64.09	Current at peak	REAL	32	-32768...32768	A	-
64.10	Dc volt at peak	REAL	32	0...2000	V	-
64.11	Speed at peak	REAL	32	-32768...32768	rpm	-
64.12	Date of reset	UINT32	32	01.01.80...	d	-
64.13	Time of reset	UINT32	32	00:00:00...23:59:59	s	-
64.14	AL1 0 to 10%	REAL	16	0...100	%	-
64.15	AL1 10 to 20%	REAL	16	0...100	%	-
64.16	AL1 20 to 30%	REAL	16	0...100	%	-
64.17	AL1 30 to 40%	REAL	16	0...100	%	-
64.18	AL1 40 to 50%	REAL	16	0...100	%	-
64.19	AL1 50 to 60%	REAL	16	0...100	%	-
64.20	AL1 60 to 70%	REAL	16	0...100	%	-
64.21	AL1 70 to 80%	REAL	16	0...100	%	-
64.22	AL1 80 to 90%	REAL	16	0...100	%	-
64.23	AL1 over 90%	REAL	16	0...100	%	-
64.24	AL2 0 to 10%	REAL	16	0...100	%	-
64.25	AL2 10 to 20%	REAL	16	0...100	%	-

No.	Name	Type	Data len.	Range	Unit	Default (Factory macro)
64.26	AL2 20 to 30%	REAL	16	0...100	%	-
64.27	AL2 30 to 40%	REAL	16	0...100	%	-
64.28	AL2 40 to 50%	REAL	16	0...100	%	-
64.29	AL2 50 to 60%	REAL	16	0...100	%	-
64.30	AL2 60 to 70%	REAL	16	0...100	%	-
64.31	AL2 70 to 80%	REAL	16	0...100	%	-
64.32	AL2 80 to 90%	REAL	16	0...100	%	-
64.33	AL2 over 90%	REAL	16	0...100	%	-
90 Enc module sel						
90.01	Encoder 1 sel	enum	16	0...7	-	None
90.02	Encoder 2 sel	enum	16	0...7	-	None
90.04	TTL echo sel	enum	16	0...5	-	Disabled
90.05	Enc cable fault	enum	16	0...2	-	Fault
90.10	Enc par refresh	enum	16	0...1	-	Done
91 Absol enc conf						
91.01	Sine cosine nr	UINT32	16	0...65535	-	0
91.02	Abs enc interf	enum	16	0...5	-	None
91.03	Rev count bits	UINT32	16	0...32	-	0
91.04	Pos data bits	UINT32	16	0...32	-	0
91.05	Refmark ena	enum	16	0...1	-	False
91.10	Hiperface parity	enum	16	0...1	-	Odd
91.11	Hiperf baudrate	enum	16	0...3	-	9600
91.12	Hiperf node addr	UINT32	16	0...255	-	64
91.20	SSI clock cycles	UINT32	16	2...127	-	2
91.21	SSI position msb	UINT32	16	1...126	-	1
91.22	SSI revol msb	UINT32	16	1...126	-	1
91.23	SSI data format	enum	16	0...1	-	binary
91.24	SSI baud rate	enum	16	0...5	-	100 kbit/s
91.25	SSI mode	enum	16	0...1	-	Initial pos.
91.26	SSI transmit cyc	enum	16	0...5	-	100 μ s
91.27	SSI zero phase	enum	16	0...3	-	315-45 deg
91.30	Endat mode	enum	16	0...1	-	Initial pos.
91.31	Endat max calc	enum	16	0...3	-	50 ms
92 Resolver conf						
92.01	Resolv polepairs	UINT32	16	1...32	-	1
92.02	Exc signal ampl	UINT32	16	4...12	Vrms	4.0 Vrms
92.03	Exc signal freq	UINT32	16	1...20	kHz	1 kHz
93 Pulse enc conf						
93.01	Enc1 pulse nr	UINT32	16	0...65535	-	0
93.02	Enc1 type	enum	16	0...1	-	Quadrature

258 Additional parameter data

No.	Name	Type	Data len.	Range	Unit	Default (Factory macro)
93.03	<i>Enc1 sp CalcMode</i>	enum	16	0...5	-	<i>Auto rising</i>
93.11	<i>Enc2 pulse nr</i>	UINT32	16	0...65535	-	0
93.12	<i>Enc2 type</i>	enum	16	0...1	-	<i>Quadrature</i>
93.13	<i>Enc2 sp CalcMode</i>	enum	16	0...5	-	<i>Auto rising</i>
94 Ext IO conf						
94.01	<i>Ext IO1 sel</i>	UINT32	16	0...3	-	<i>None</i>
94.02	<i>Ext IO2 sel</i>	UINT32	16	0...3	-	<i>None</i>
95 Hw configuration						
95.01	<i>Ctrl boardSupply</i>	enum	16	0...1	-	<i>Internal 24V</i>
95.03	<i>Temp inu ambient</i>	INT32	16	0...55	°C	40 °C
97 User motor par						
97.01	<i>Use given params</i>	enum	16	0...3	-	<i>NoUserPars</i>
97.02	<i>Rs user</i>	REAL24	32	0...0.5	p.u.	0.00000 p.u.
97.03	<i>Rr user</i>	REAL24	32	0...0.5	p.u.	0.00000 p.u.
97.04	<i>Lm user</i>	REAL24	32	0...10	p.u.	0.00000 p.u.
97.05	<i>SigmaL user</i>	REAL24	32	0...1	p.u.	0.00000 p.u.
97.06	<i>Ld user</i>	REAL24	32	0...10	p.u.	0.00000 p.u.
97.07	<i>Lq user</i>	REAL24	32	0...10	p.u.	0.00000 p.u.
97.08	<i>Pm flux user</i>	REAL24	32	0...2	p.u.	0.00000 p.u.
97.09	<i>Rs user SI</i>	REAL24	32	0...100	ohm	0.00000 Ohm
97.10	<i>Rr user SI</i>	REAL24	32	0...100	ohm	0.00000 Ohm
97.11	<i>Lm user SI</i>	REAL24	32	0...100000	mH	0.00 mH
97.12	<i>SigL user SI</i>	REAL24	32	0...100000	mH	0.00 mH
97.13	<i>Ld user SI</i>	REAL24	32	0...100000	mH	0.00 mH
97.14	<i>Lq user SI</i>	REAL24	32	0...100000	mH	0.00 mH
97.20	<i>PM angle offset</i>	REAL	32	0...360	° (el.)	0°
99 Start-up data						
99.01	<i>Language</i>	enum	16	-	-	<i>English</i>
99.04	<i>Motor type</i>	enum	16	0...1	-	<i>AM</i>
99.05	<i>Motor ctrl mode</i>	enum	16	0...1	-	<i>DTC</i>
99.06	<i>Mot nom current</i>	REAL	32	0...6400	A	0.0 A
99.07	<i>Mot nom voltage</i>	REAL	32	$1/6 \dots 2 \times U_N$	V	0.0 V
99.08	<i>Mot nom freq</i>	REAL	32	5...500	Hz	0.0 Hz
99.09	<i>Mot nom speed</i>	REAL	32	0...10000	rpm	0 rpm
99.10	<i>Mot nom power</i>	REAL	32	0...10000	kW or hp	0.00 kW
99.11	<i>Mot nom cosfii</i>	REAL24	32	0...1	-	0.00
99.12	<i>Mot nom torque</i>	INT32	32	0...2147483.647	Nm	0.000 Nm
99.13	<i>IDrun mode</i>	enum	16	0...5	-	<i>No</i>



Fault tracing

What this chapter contains

The chapter lists the alarm (warning) and fault messages including possible causes and corrective actions.

Safety



WARNING! Only qualified electricians are allowed to maintain the drive. The *Safety Instructions* on the first pages of the appropriate hardware manual must be read before you start working with the drive.

Alarm and fault indications

An alarm or a fault message indicates abnormal drive status. Most alarm and fault causes can be identified and corrected using this information. If not, an ABB representative should be contacted.

The four-digit code number in brackets after the message is for the fieldbus communication.

The alarm/fault code is displayed on the 7-segment display of the drive. The following table describes the indications given by the 7-segment display.

Display	Meaning
“E-” followed by error code	System error. See appropriate drive hardware manual.
“A-” followed by error code	Alarm. See section <i>Alarm messages generated by the drive</i> on page 260.
“F-” followed by error code	Fault. See section <i>Fault messages generated by the drive</i> on page 268.

How to reset

The drive can be reset either by pressing the RESET key on the control panel or PC tool, or by switching the supply voltage off for a while. When the fault has been removed, the motor can be restarted.

A fault can also be reset from an external source selected by parameter [10.10 Fault reset sel.](#)

Fault history

When fault is detected, it is stored in the fault logger with a time stamp. The fault history stores information on the 16 latest faults of the drive. Three of the latest faults are stored at the beginning of a power switch off.

Parameters [08.01 Active fault](#) and [08.02 Last fault](#) store the fault codes of the most recent faults.

Alarms can be monitored via alarm words [08.05 Alarm word1](#) ... [08.08 Alarm word4](#). Alarm information is lost at power switch off or fault reset.

Alarm messages generated by the drive

Code	Alarm (fieldbus code)	Cause	What to do
2000	BRAKE START TORQUE (0x7185) Programmable fault: 42.12 Brake fault func	Mechanical brake alarm. Alarm is activated if required motor starting torque (42.08 Brake open torq) is not achieved.	Check brake open torque setting, parameter 42.08 . Check drive torque and current limits. See parameter group 20 Limits .
2001	BRAKE NOT CLOSED (0x7186) Programmable fault: 42.12 Brake fault func	Mechanical brake control alarm. Alarm is activated e.g. if brake acknowledgement is not as expected during brake closing.	Check mechanical brake connection. Check mechanical brake settings in parameter group 42 Mech brake ctrl . To determine whether problem is with acknowledgement signal or brake, check if brake is closed or open.
2002	BRAKE NOT OPEN (0x7187) Programmable fault: 42.12 Brake fault func	Mechanical brake control alarm. Alarm is activated e.g. if brake acknowledgement is not as expected during brake opening.	Check mechanical brake connection. Check mechanical brake settings in parameter group 42 Mech brake ctrl . To determine whether problem is with acknowledgement signal or brake, check if brake is closed or open.
2003	SAFE TORQUE OFF (0xFF7A) Programmable fault: 30.07 Sto diagnostic	Safe Torque Off function is active, i.e. safety circuit signal(s) connected to connector X6 is lost while drive is stopped and parameter 30.07 Sto diagnostic is set to <i>Alarm</i> .	Check safety circuit connections. For more information, see appropriate drive hardware manual.
2004	STO MODE CHANGE (0xFF7A)	Error in changing Safe Torque Off supervision, i.e. parameter 30.07 Sto diagnostic setting could not be changed to value <i>Alarm</i> .	Contact your local ABB representative.

Code	Alarm (fieldbus code)	Cause	What to do
2005	MOTOR TEMPERATURE (0x4310) Programmable fault: 31.01 Mot temp1 prot	Estimated motor temperature (based on motor thermal model) has exceeded alarm limit defined by parameter 31.03 Mot temp1 almLim .	Check motor ratings and load. Let motor cool down. Ensure proper motor cooling: Check cooling fan, clean cooling surfaces, etc. Check value of alarm limit. Check motor thermal model settings (parameters 31.09...31.14).
		Measured motor temperature has exceeded alarm limit defined by parameter 31.03 Mot temp1 almLim .	Check that actual number of sensors corresponds to value set by parameter 31.02 Mot temp1 src . Check motor ratings and load. Let motor cool down. Ensure proper motor cooling: Check cooling fan, clean cooling surfaces, etc. Check value of alarm limit.
2006	EMERGENCY OFF (0xF083)	Drive has received emergency OFF2 command.	To restart drive, activate run enable signal (source selected by parameter 10.11 Run enable) and start drive.
2007	RUN ENABLE (0xFF54)	No run enable signal is received.	Check setting of parameter 10.11 Run enable . Switch signal on (e.g. in the fieldbus Control Word) or check wiring of selected source.
2008	ID-RUN (0xFF84)	Motor identification run is on.	This alarm belongs to normal start-up procedure. Wait until drive indicates that motor identification is completed.
		Motor identification is required.	This alarm belongs to normal start-up procedure. Select how motor identification should be performed, parameter 99.13 IDrun mode . Start identification routines by pressing Start key.
2009	EMERGENCY STOP (0xF081)	Drive has received emergency stop command (OFF1/OFF3).	Check that it is safe to continue operation. Return emergency stop push button to normal position (or adjust the fieldbus Control Word accordingly). Restart drive.
2011	BR OVERHEAT (0x7112)	Brake resistor temperature has exceeded alarm limit defined by parameter 48.07 Br temp alarmlim .	Stop drive. Let resistor cool down. Check resistor overload protection function settings (parameters 48.01...48.05). Check alarm limit setting, parameter 48.07 Br temp alarmlim . Check that braking cycle meets allowed limits.
2012	BC OVERHEAT (0x7181)	Brake chopper IGBT temperature has exceeded internal alarm limit.	Let chopper cool down. Check resistor overload protection function settings (parameters 48.01...48.05). Check that braking cycle meets allowed limits. Check that drive supply AC voltage is not excessive.

Code	Alarm (fieldbus code)	Cause	What to do
2013	DEVICE OVERTEMP (0x4210)	Measured drive temperature has exceeded internal alarm limit.	Check ambient conditions. Check air flow and fan operation. Check heatsink fins for dust pick-up. Check motor power against unit power.
2014	INTBOARD OVERTEMP (0x7182)	Interface board (between power unit and control unit) temperature has exceeded internal alarm limit.	Let drive cool down.
2015	BC MOD OVERTEMP (0x7183)	Input bridge or brake chopper temperature has exceeded internal alarm limit.	Let drive cool down.
2016	IGBT OVERTEMP (0x7184)	Drive temperature based on thermal model has exceeded internal alarm limit.	Check ambient conditions. Check air flow and fan operation. Check heatsink fins for dust pick-up. Check motor power against unit power.
2017	FIELDBUS COMM (0x7510) Programmable fault: 50.02 Comm loss func	Cyclical communication between drive and fieldbus adapter module or between PLC and fieldbus adapter module is lost.	Check status of fieldbus communication. See appropriate User's Manual of fieldbus adapter module. Check settings of parameter group 50 Fieldbus . Check cable connections. Check if communication master is able to communicate.
2018	LOCAL CTRL LOSS (0x5300) Programmable fault: 30.03 Local ctrl loss	Control panel or PC tool selected as active control location for drive has ceased communicating.	Check PC tool or control panel connection. Check control panel connector. Replace control panel in mounting platform.
2019	AI SUPERVISION (0x8110) Programmable fault: 13.32 AI superv func	An analogue input has reached limit defined by parameter 13.33 AI superv cw .	Check analogue input source and connections. Check analogue input minimum and maximum limit settings.
2020	FB PAR CONF (0x6320)	The drive does not have a functionality requested by PLC, or requested functionality has not been activated.	Check PLC programming. Check settings of parameter group 50 Fieldbus .
2021	NO MOTOR DATA (0x6381)	Parameters in group 99 have not been set.	Check that all the required parameters in group 99 have been set. Note: It is normal for this alarm to appear during the start-up until the motor data is entered.
2022	ENCODER 1 FAILURE (0x7301)	Encoder 1 has been activated by parameter but the encoder interface (FEN-xx) cannot be found.	Check parameter 90.01 Encoder 1 sel setting corresponds to actual encoder interface 1 (FEN-xx) installed in drive Slot 1/2 (parameter 09.20 Option slot1 / 09.21 Option slot2). Note: The new setting will only take effect after parameter 90.10 Enc par refresh is used or after the JCU Control Unit is powered up the next time.

Code	Alarm (fieldbus code)	Cause	What to do
2023	ENCODER 2 FAILURE (0x7381)	Encoder 2 has been activated by parameter but the encoder interface (FEN-xx) cannot be found.	<p>Check parameter 90.02 Encoder 2 sel setting corresponds to actual encoder interface 1 (FEN-xx) installed in drive Slot 1/2 (parameter 09.20 Option slot1 / 09.21 Option slot2).</p> <p>Note: The new setting will only take effect after parameter 90.10 Enc par refresh is used or after the JCU Control Unit is powered up the next time.</p>
2027	FEN TEMP MEAS FAILURE (0x7385)	<p>Error in temperature measurement when temperature sensor (KTY or PTC) connected to encoder interface FEN-xx is used.</p>	<p>Check that parameter 31.02 Mot temp1 src / 31.06 Mot temp2 src setting corresponds to actual encoder interface installation (09.20 Option slot1 / 09.21 Option slot2):</p> <p>If one FEN-xx module is used:</p> <ul style="list-style-type: none"> - Parameter 31.02 Mot temp1 src / 31.06 Mot temp2 src must be set either to KTY 1st FEN or PTC 1st FEN. The FEN-xx module can be in either Slot 1 or Slot 2. <p>If two FEN-xx modules are used:</p> <ul style="list-style-type: none"> - When parameter 31.02 Mot temp1 src / 31.06 Mot temp2 src is set to KTY 1st FEN or PTC 1st FEN, the encoder installed in drive Slot 1 is used. - When parameter 31.02 Mot temp1 src / 31.06 Mot temp2 src is set to KTY 2nd FEN or PTC 2nd FEN, the encoder installed in drive Slot 2 is used.
		<p>Error in temperature measurement when KTY sensor connected to encoder interface FEN-01 is used.</p>	<p>FEN-01 does not support temperature measurement with KTY sensor. Use PTC sensor or other encoder interface module.</p>
2030	RESOLVER AUTOTUNE ERR (0x7388)	Resolver autotuning routines, which are automatically started when resolver input is activated for the first time, have failed.	<p>Check cable between resolver and resolver interface module (FEN-21) and order of connector signal wires at both ends of cable.</p> <p>Check resolver parameter settings. For resolver parameters and information, see parameter group 92 Resolver conf.</p> <p>Note: Resolver autotuning routines should always be performed after resolver cable connection has been modified. Autotuning routines can be activated by setting parameter 92.02 Exc signal ampl or 92.03 Exc signal freq, and then setting parameter 90.10 Enc par refresh to Configure.</p>
2031	ENCODER 1 CABLE (0x7389)	Encoder 1 cable fault detected.	<p>Check cable between FEN-xx interface and encoder 1. After any modifications in cabling, re-configure interface by switching drive power off and on, or by activating parameter 90.10 Enc par refresh.</p>

264 Fault tracing

Code	Alarm (fieldbus code)	Cause	What to do
2032	ENCODER 2 CABLE (0x738A)	Encoder 2 cable fault detected.	Check cable between FEN-xx interface and encoder 2. After any modifications in cabling, re-configure interface by switching drive power off and on, or by activating parameter 90.10 Enc par refresh .
2033	D2D COMMUNICATION (0x7520) Programmable fault: 57.02 Comm loss func	On the master drive: The drive has not been replied to by an activated follower for five consecutive polling cycles.	Check that all drives that are polled (parameters 57.04 Follower mask 1 and 57.05 Follower mask 2) on the drive-to-drive link are powered, properly connected to the link, and have the correct node address. Check the drive-to-drive link wiring.
		On a follower drive: The drive has not received new reference 1 and/or 2 for five consecutive reference handling cycles.	Check the settings of parameters 57.06 Ref 1 src and 57.07 Ref 2 src on the master drive. Check the drive-to-drive link wiring.
2034	D2D BUFFER OVERLOAD (0x7520) Programmable fault: 57.02 Comm loss func	Transmission of drive-to-drive references failed because of message buffer overflow.	Contact your local ABB representative.
2035	PS COMM (0x5480)	Communication errors detected between the JCU Control Unit and the power unit of the drive.	Check the connections between the JCU Control Unit and the power unit.
2036	RESTORE (0x6300)	Restoration of backed-up parameters failed.	Contact your local ABB representative.
2037	CUR MEAS CALIBRATION (0x2280)	Current measurement calibration will occur at next start.	Informative alarm.
2038	AUTOPHASING (0x3187)	Autophasing will occur at next start.	Informative alarm.
2039	EARTH FAULT (0x2330) Programmable fault: 30.05 Earth fault	Drive has detected load unbalance typically due to earth fault in motor or motor cable.	Check there are no power factor correction capacitors or surge absorbers in motor cable. Check for an earth fault in motor or motor cables by measuring the insulation resistances of motor and motor cable. If no earth fault can be detected, contact your local ABB representative.
2040	AUTORESET (0x6080)	A fault is to be autoreset.	Informative alarm. See parameter group 32 Automatic reset .
2041	MOTOR NOM VALUE (0x6383)	The motor configuration parameters are set incorrectly.	Check the settings of the motor configuration parameters in group 99.
		The drive is not dimensioned correctly.	Check that the drive is sized correctly for the motor.
2042	D2D CONFIG (0x7583)	The settings of drive-to-drive link configuration parameters (group 57) are incompatible.	Check the settings of the parameters in group 57 D2D communication .

Code	Alarm (fieldbus code)	Cause	What to do
2043	STALL (0x7121) Programmable fault: 30.09 Stall function	Motor is operating in stall region because of e.g. excessive load or insufficient motor power.	Check motor load and drive ratings. Check fault function parameters.
2044	LCURVE (0x2312) Programmable fault: 34.01 Overload func / 34.02 Underload func	Overload or underload limit has been exceeded.	Check the settings of the parameters in group 34 User load curve .
2045	LCURVE PAR (0x6320)	The load curve has been incorrectly or inconsistently defined.	Check the settings of the parameters in group 34 User load curve .
2046	FLUX REF PAR (0x6320)	The U/f (voltage/frequency) curve has been incorrectly or inconsistently defined.	Check the settings of the parameters in group 38 Flux ref .
2047	SPEED FEEDBACK (0x8480)	No speed feedback is received.	Check the settings of the parameters in group 19 Speed calculation . Check encoder installation. See the description of fault 0039 for more information.
2048	OPTION COMM LOSS (0x7000)	Communication between drive and option module (FEN-xx and/or FIO-xx) is lost.	Check that option modules are properly connected to Slot 1 and (or) Slot 2. Check that option modules or Slot 1/2 connectors are not damaged. To determine whether module or connector is damaged: Test each module individually in Slot 1 and Slot 2.
2049	MOTTEMPAL2 (0x4313) Programmable fault: 31.05 Mot temp2 prot	Estimated motor temperature (based on motor thermal model) has exceeded alarm limit defined by parameter 31.07 Mot temp2 almLim .	Check motor ratings and load. Let motor cool down. Ensure proper motor cooling: Check cooling fan, clean cooling surfaces, etc. Check value of alarm limit. Check motor thermal model settings (parameters 31.09...31.14).
		Measured motor temperature has exceeded alarm limit defined by parameter 31.07 Mot temp2 almLim .	Check that actual number of sensors corresponds to value set by parameter 31.06 Mot temp2 src . Check motor ratings and load. Let motor cool down. Ensure proper motor cooling: Check cooling fan, clean cooling surfaces, etc. Check value of alarm limit.
2050	IGBTOLALARM (0x5482)	Excessive IGBT junction to case temperature. This alarm protects the IGBT(s) and can be activated by a short circuit in the motor cable.	Check motor cable.
2051	IGBTTEMPALARM (0x4210)	Drive IGBT temperature is excessive.	Check ambient conditions. Check air flow and fan operation. Check heatsink fins for dust pick-up. Check motor power against drive power.

Code	Alarm (fieldbus code)	Cause	What to do
2052	COOLALARM (0x4290)	Drive module temperature is excessive.	Check ambient temperature. If it exceeds 40 °C (104 °F), ensure that load current does not exceed derated load capacity of drive. See appropriate <i>Hardware Manual</i> . Check drive module cooling air flow and fan operation. Check inside of cabinet and heatsink of drive module for dust pick-up. Clean whenever necessary.
2053	MENU CHG PASSWORD REQ (0x6F81)	Loading a parameter listing requires a password.	Enter password at parameter 16.03 Pass code .
2054	MENU CHANGED (0x6F82)	A different parameter listing is being loaded.	Informative alarm.
2055	DEVICE CLEAN (0x5080)	Maintenance alarm.	See parameter group 44 Maintenance .
2056	COOLING FAN (0x5081)	Maintenance alarm.	See parameter group 44 Maintenance .
2057	ADD COOLING (0x5082)	Maintenance alarm.	See parameter group 44 Maintenance .
2058	CABINET FAN (0x5083)	Maintenance alarm.	See parameter group 44 Maintenance .
2059	DC CAPACITOR (0x5084)	Maintenance alarm.	See parameter group 44 Maintenance .
2060	MOTOR BEARING (0x738C)	Maintenance alarm.	See parameter group 44 Maintenance .
2061	MAIN CONTACTOR (0x548D)	Maintenance alarm.	See parameter group 44 Maintenance .
2062	RELAY OUTPUT SW (0x548E)	Maintenance alarm.	See parameter group 44 Maintenance .
2063	MOTOR START COUNT (0x6180)	Maintenance alarm.	See parameter group 44 Maintenance .
2064	POWER UP COUNT (0x6181)	Maintenance alarm.	See parameter group 44 Maintenance .
2065	DC CHARGE COUNT (0x6182)	Maintenance alarm.	See parameter group 44 Maintenance .
2066	ONTIME1 ALARM (0x5280)	Maintenance alarm.	See parameter group 44 Maintenance .
2067	ONTIME2 ALARM (0x5281)	Maintenance alarm.	See parameter group 44 Maintenance .
2068	EDGE1 ALARM (0x5282)	Maintenance alarm.	See parameter group 44 Maintenance .
2069	EDGE2 ALARM (0x5283)	Maintenance alarm.	See parameter group 44 Maintenance .
2070	VALUE1 ALARM (0x5284)	Maintenance alarm.	See parameter group 44 Maintenance .
2071	VALUE2 ALARM (0x5285)	Maintenance alarm.	See parameter group 44 Maintenance .

Code	Alarm (fieldbus code)	Cause	What to do
2073	AUTOTUNE FAILED (0x8481)	Speed controller autotune routine did not finish successfully.	See parameter 23.20 PI tune mode .
2074	START INTERLOCK (0xF082)	No Start interlock signal received.	Check circuit connected to DIIL input.

Fault messages generated by the drive

Code	Fault (fieldbus code)	Cause	What to do
0001	OVERCURRENT (0x2310)	Output current has exceeded internal fault limit.	<p>Check motor load.</p> <p>Check acceleration times in parameter group 22 Speed ref ramp.</p> <p>Check motor and motor cable (including phasing and delta/star connection).</p> <p>Check that the start-up data in parameter group 99 corresponds to the motor rating plate.</p> <p>Check that there are no power factor correction capacitors or surge absorbers in motor cable.</p> <p>Check encoder cable (including phasing).</p>
0002	DC OVERVOLTAGE (0x3210)	Excessive intermediate circuit DC voltage	<p>Check that overvoltage controller is on, parameter 47.01 Overvolt ctrl.</p> <p>Check mains for static or transient overvoltage.</p> <p>Check brake chopper and resistor (if used).</p> <p>Check deceleration time.</p> <p>Use coast-to-stop function (if applicable).</p> <p>Retrofit frequency converter with brake chopper and brake resistor.</p>
0004	SHORT CIRCUIT (0x2340)	Short-circuit in motor cable(s) or motor	<p>Check motor and motor cable.</p> <p>Check there are no power factor correction capacitors or surge absorbers in motor cable.</p>
0005	DC UNDERVOLTAGE (0x3220)	Intermediate circuit DC voltage is not sufficient due to missing mains phase, blown fuse or rectifier bridge internal fault.	<p>Check mains supply and fuses.</p>
0006	EARTH FAULT (0x2330) Programmable fault: 30.05 Earth fault	Drive has detected load unbalance typically due to earth fault in motor or motor cable.	<p>Check there are no power factor correction capacitors or surge absorbers in motor cable.</p> <p>Check that there is no earth fault in motor or motor cables:</p> <ul style="list-style-type: none"> - measure insulation resistances of motor and motor cable. <p>If no earth fault can be detected, contact your local ABB representative.</p>
0007	FAN FAULT (0xFF83)	Fan is not able to rotate freely or fan is disconnected. Fan operation is monitored by measuring fan current.	<p>Check fan operation and connection.</p>
0008	IGBT OVERTEMP (0x7184)	Drive temperature based on thermal model has exceeded internal fault limit.	<p>Check ambient conditions.</p> <p>Check air flow and fan operation.</p> <p>Check heatsink fins for dust pick-up.</p> <p>Check motor power against unit power.</p>
0009	BC WIRING (0x7111)	Brake resistor short circuit or brake chopper control fault	<p>Check brake chopper and brake resistor connection.</p> <p>Ensure brake resistor is not damaged.</p>

Code	Fault (fieldbus code)	Cause	What to do
0010	BC SHORT CIRCUIT (0x7113)	Short circuit in brake chopper IGBT	Replace brake chopper. Ensure brake resistor is connected and not damaged.
0011	BC OVERHEAT (0x7181)	Brake chopper IGBT temperature has exceeded internal fault limit.	Let chopper cool down. Check resistor overload protection function settings (parameters 48.01...48.05). Check that braking cycle meets allowed limits. Check that drive supply AC voltage is not excessive.
0012	BR OVERHEAT (0x7112)	Brake resistor temperature has exceeded fault limit defined by parameter 48.06 Br temp faultlim .	Stop drive. Let resistor cool down. Check resistor overload protection function settings (parameters 48.01...48.05). Check fault limit setting, parameter 48.06 Br temp faultlim . Check that braking cycle meets allowed limits.
0013	CURR MEAS GAIN (0x3183)	Difference between output phase U2 and W2 current measurement gain is too great.	Contact your local ABB representative.
0014	CABLE CROSS CON (0x3181) Programmable fault: 30.08 Cross connection	Incorrect input power and motor cable connection (i.e. input power cable is connected to drive motor connection).	Check input power connections.
0015	SUPPLY PHASE (0x3130) Programmable fault: 30.06 Suppl phs loss	Intermediate circuit DC voltage is oscillating due to missing input power line phase or blown fuse.	Check input power line fuses. Check for input power supply imbalance.
0016	MOTOR PHASE (0x3182) Programmable fault: 30.04 Mot phase loss	Motor circuit fault due to missing motor connection (all three phases are not connected).	Connect motor cable.
0017	ID-RUN FAULT (0xFF84)	Motor ID Run is not completed successfully.	Check motor settings (parameters 99.04...99.13). Check that no limits prevent ID run. The following must apply: 20.05 Maximum current \geq 99.06 Mot nom current For Reduced and Normal ID run: – 20.01 Maximum speed $>$ 55% of 99.09 Mot nom speed – 20.02 Minimum speed \leq 0 – Supply voltage \geq 65% of 99.07 Mot nom voltage – Maximum torque (selected by 20.06 Torq lim sel) \geq 100% (only for Normal ID run). Retry.

270 Fault tracing

Code	Fault (fieldbus code)	Cause	What to do
0018	CURR U2 MEAS (0x3184)	Measured offset error of U2 output phase current measurement is too great. (Offset value is updated during current calibration.)	Contact your local ABB representative.
0019	CURR V2 MEAS (0x3185)	Measured offset error of V2 output phase current measurement is too great. (Offset value is updated during current calibration.)	Contact your local ABB representative.
0020	CURR W2 MEAS (0x3186)	Measured offset error of W2 output phase current measurement is too great. (Offset value is updated during current calibration.)	Contact your local ABB representative.
0021	STO1 LOST (0x8182)	Safe Torque Off function is active, i.e. safety circuit signal 1 connected between X6:1 and X6:3 is lost while drive is at stopped state and parameter 30.07 Sto diagnostic is set to <i>Alarm</i> or <i>No</i> .	Check safety circuit connections. For more information, see appropriate drive hardware manual.
0022	STO2 LOST (0x8183)	Safe Torque Off function is active, i.e. safety circuit signal 2 connected between X6:2 and X6:4 is lost while drive is at stopped state and parameter 30.07 Sto diagnostic is set to <i>Alarm</i> or <i>No</i> .	Check safety circuit connections. For more information, see appropriate drive hardware manual.
0023	STO MODE CHANGE (0xFF7A)	Error in changing Safe Torque Off supervision, i.e. parameter 30.07 Sto diagnostic setting could not be changed to value <i>Fault</i> .	Contact your local ABB representative.
0024	INTBOARD OVERTEMP (0x7182)	Interface board (between power unit and control unit) temperature has exceeded internal fault limit.	Let drive cool down.
0025	BC MOD OVERTEMP (0x7183)	Input bridge or brake chopper temperature has exceeded internal fault limit.	Let drive cool down.
0026	AUTOPHASING (0x3187)	Autophasing routine (see section Autophasing on page 58) failed.	Try other autophasing modes (see parameter 11.07 Autophasing mode) if possible.
0027	PU LOST (0x5400)	Connection between the JCU Control Unit and the power unit of the drive is lost.	Check the connections between the JCU Control Unit and the power unit.
0028	PS COMM (0x5480)	Communication errors detected between the JCU Control Unit and the power unit of the drive.	Check the connections between the JCU Control Unit and the power unit.
0029	IN CHOKE TEMP (0xFF81)	Temperature of internal AC choke excessive.	Check cooling fan.

Code	Fault (fieldbus code)	Cause	What to do
0030	EXTERNAL (0x9000)	Fault in external device. (This information is configured through one of programmable digital inputs.)	Check external devices for faults. Check parameter 30.01 External fault setting.
0031	SAFE TORQUE OFF (0xFF7A) Programmable fault: Programmable fault: 30.07 Sto diagnostic	Safe Torque Off function is active, i.e. safety circuit signal(s) connected to connector X6 is lost during start or run, or while drive is stopped and parameter 30.07 Sto diagnostic is set to <i>Fault</i> .	Check safety circuit connections. For more information, see appropriate drive hardware manual.
0032	OVERSPEED (0x7310)	Motor is turning faster than highest allowed speed due to incorrectly set minimum/maximum speed, insufficient braking torque or changes in load when using torque reference.	Check minimum/maximum speed settings, parameters 20.01 Maximum speed and 20.02 Minimum speed . Check adequacy of motor braking torque. Check applicability of torque control. Check need for brake chopper and resistor(s).
0033	BRAKE START TORQUE (0x7185) Programmable fault: 42.12 Brake fault func	Mechanical brake fault. Fault is activated if required motor starting torque (42.08 Brake open torq) is not achieved.	Check brake open torque setting, parameter 42.08 . Check drive torque and current limits. See parameter group 20 Limits .
0034	BRAKE NOT CLOSED (0x7186) Programmable fault: 42.12 Brake fault func	Mechanical brake control fault. Activated e.g. if brake acknowledgement is not as expected during brake closing.	Check mechanical brake connection. Check mechanical brake settings in parameter group 42 Mech brake ctrl . To determine whether problem is with acknowledgement signal or brake, check if brake is closed or open.
0035	BRAKE NOT OPEN (0x7187) Programmable fault: 42.12 Brake fault func	Mechanical brake control fault. Activated e.g. if brake acknowledgement is not as expected during brake opening.	Check mechanical brake connection. Check mechanical brake settings in parameter group 42 Mech brake ctrl . To determine whether problem is with acknowledgement signal or brake, check if brake is closed or open.
0036	LOCAL CTRL LOSS (0x5300) Programmable fault: 30.03 Local ctrl loss	Control panel or PC tool selected as active control location for drive has ceased communicating.	Check PC tool or control panel connection. Check control panel connector. Replace control panel in mounting platform.
0037	NVMEM CORRUPTED (0x6320)	Drive internal fault Note: This fault cannot be reset.	Contact your local ABB representative.
0038	OPTIONCOMM LOSS (0x7000)	Communication between drive and option module (FEN-xx and/or FIO-xx) is lost.	Check that option modules are properly connected to Slot 1 and (or) Slot 2. Check that option modules or Slot 1/2 connectors are not damaged. To determine whether module or connector is damaged: Test each module individually in Slot 1 and Slot 2.

Code	Fault (fieldbus code)	Cause	What to do
0039	ENCODER1 (0x7301)	Encoder 1 feedback fault	<p>If fault appears during first start-up before encoder feedback is used:</p> <ul style="list-style-type: none"> - Check cable between encoder and encoder interface module (FEN-xx) and order of connector signal wires at both ends of cable. <p>If fault appears after encoder feedback has already been used or during drive run:</p> <ul style="list-style-type: none"> - Check that encoder connection wiring or encoder is not damaged. - Check that encoder interface module (FEN-xx) connection or module is not damaged. - Check earthings (when disturbances are detected in communication between encoder interface module and encoder). <p>For more information on encoders, see parameter groups 90 Enc module sel, 92 Resolver conf and 93 Pulse enc conf.</p>
0040	ENCODER 2 (0x7381)	Encoder 2 feedback fault.	See fault 0039 .
0045	FIELD BUS COMM (0x7510) Programmable fault: 50.02 Comm loss func	Cyclical communication between drive and fieldbus adapter module or between PLC and fieldbus adapter module is lost.	<p>Check status of fieldbus communication. See appropriate User's Manual of fieldbus adapter module.</p> <p>Check settings of parameter group 50 Fieldbus.</p> <p>Check cable connections.</p> <p>Check if communication master is able to communicate.</p>
0046	FB MAPPING FILE (0x6306)	Drive internal fault	Contact your local ABB representative.
0047	MOTOR OVERTEMP (0x4310) Programmable fault: 31.01 Mot temp1 prot	Estimated motor temperature (based on motor thermal model) has exceeded fault limit defined by parameter 31.04 Mot temp1 fltLim .	<p>Check motor ratings and load.</p> <p>Let motor cool down. Ensure proper motor cooling: Check cooling fan, clean cooling surfaces, etc.</p> <p>Check value of fault limit.</p> <p>Check motor thermal model settings (parameters 31.09...31.14).</p>
		Measured motor temperature has exceeded fault limit defined by parameter 31.04 Mot temp1 fltLim .	<p>Check that actual number of sensors corresponds to value set by parameter 31.02 Mot temp1 src.</p> <p>Check motor ratings and load.</p> <p>Let motor cool down. Ensure proper motor cooling: Check cooling fan, clean cooling surfaces, etc.</p> <p>Check value of fault limit.</p>
0049	AI SUPERVISION (0x8110) Programmable fault: 13.32 Ai superv func	An analogue input has reached limit defined by parameter 13.33 Ai superv cw .	<p>Check analogue input source and connections.</p> <p>Check analogue input minimum and maximum limit settings.</p>

Code	Fault (fieldbus code)	Cause	What to do
0050	ENCODER 1 CABLE (0x7389) Programmable fault: 90.05 Enc cable fault	Encoder 1 cable fault detected.	Check cable between FEN-xx interface and encoder 1. After any modifications in cabling, re-configure interface by switching drive power off and on, or by activating parameter 90.10 Enc par refresh .
0051	ENCODER 2 CABLE (0x738A) Programmable fault: 90.05 Enc cable fault	Encoder 2 cable fault detected.	Check cable between FEN-xx interface and encoder 2. After any modifications in cabling, re-configure interface by switching drive power off and on, or by activating parameter 90.10 Enc par refresh .
0052	D2D CONFIG (0x7583)	Configuration of the drive-to-drive link has failed for a reason other than those indicated by alarm A-2042, for example start inhibition is requested but not granted.	Contact your local ABB representative.
0053	D2D COMM (0x7520) Programmable fault: 57.02 Comm loss func	On the master drive: The drive has not been replied to by an activated follower for five consecutive polling cycles.	Check that all drives that are polled (parameters 57.04 Follower mask 1 and 57.05 Follower mask 2) on the drive-to-drive link are powered, properly connected to the link, and have the correct node address. Check the drive-to-drive link wiring.
		On a follower drive: The drive has not received new reference 1 and/or 2 for five consecutive reference handling cycles.	Check the settings of parameters 57.06 Ref 1 src and 57.07 Ref 2 src on the master drive. Check the drive-to-drive link wiring.
0054	D2D BUF OVLOAD (0x7520) Programmable fault: 90.05 Enc cable fault	Transmission of drive-to-drive references failed because of message buffer overflow.	Contact your local ABB representative.
0055	TECH LIB (0x6382)	Resettable fault generated by a technology library.	Refer to the documentation of the technology library.
0056	TECH LIB CRITICAL (0x6382)	Permanent fault generated by a technology library.	Refer to the documentation of the technology library.
0057	FORCED TRIP (0xFF90)	Generic Drive Communication Profile trip command.	Check PLC status.
0058	FB PAR ERROR (0x6320)	The drive does not have a functionality requested by PLC, or requested functionality has not been activated.	Check PLC programming. Check settings of parameter group 50 Fieldbus .
0059	STALL (0x7121) Programmable fault: 30.09 Stall function	Motor is operating in stall region because of e.g. excessive load or insufficient motor power.	Check motor load and drive ratings. Check fault function parameters.
0060	LOAD CURVE (0x2312) Programmable fault: 34.01 Overload func / 34.02 Underload func	Overload or underload limit has been exceeded.	Check the settings of the parameters in group 34 User load curve .

Code	Fault (fieldbus code)	Cause	What to do
0061	SPEED FEEDBACK (0x8480)	No speed feedback is received.	Check the settings of the parameters in group 19 Speed calculation . Check encoder installation. See the description of fault 0039 (ENCODER1) for more information.
0062	D2D SLOT COMM (0x7584)	Drive-to-drive link is set to use an FSCA module for communication, but no module is detected in specified slot.	Check the settings of parameters 57.01 and 57.15 . Ensure that the FSCA module has been detected by checking parameters 09.20 ... 09.22 . Check that the FSCA module is correctly wired. Try installing the FSCA module into another slot. If the problem persists, contact your local ABB representative.
0063	MOTOR TEMP2 (0x4313) Programmable fault: 31.05 Mot temp2 prot	Estimated motor temperature (based on motor thermal model) has exceeded fault limit defined by parameter 31.08 Mot temp2 fitLim .	Check motor ratings and load. Let motor cool down. Ensure proper motor cooling: Check cooling fan, clean cooling surfaces, etc. Check value of alarm limit. Check motor thermal model settings (parameters 31.09 ... 31.14).
		Measured motor temperature has exceeded fault limit defined by parameter 31.08 Mot temp2 fitLim .	Check that actual number of sensors corresponds to value set by parameter 31.06 Mot temp2 src . Check motor ratings and load. Let motor cool down. Ensure proper motor cooling: Check cooling fan, clean cooling surfaces, etc. Check value of alarm limit.
0064	IGBT OVERLOAD (0x5482)	Excessive IGBT junction to case temperature. This fault protects the IGBT(s) and can be activated by a short circuit in the motor cable.	Check motor cable.
0065	IGBT TEMP (0x4210)	Drive IGBT temperature is excessive.	Check ambient conditions. Check air flow and fan operation. Check heatsink fins for dust pick-up. Check motor power against drive power.
0066	COOLING (0x4290)	Drive module temperature is excessive.	Check ambient temperature. If it exceeds 40 °C (104 °F), ensure that load current does not exceed derated load capacity of drive. See appropriate <i>Hardware Manual</i> . Check drive module cooling air flow and fan operation. Check inside of cabinet and heatsink of drive module for dust pick-up. Clean whenever necessary.
0201	T2 OVERLOAD (0x0201)	Firmware time level 2 overload Note: This fault cannot be reset.	Contact your local ABB representative.
0202	T3 OVERLOAD (0x6100)	Firmware time level 3 overload Note: This fault cannot be reset.	Contact your local ABB representative.

Code	Fault (fieldbus code)	Cause	What to do
0203	T4 OVERLOAD (0x6100)	Firmware time level 4 overload Note: This fault cannot be reset.	Contact your local ABB representative.
0204	T5 OVERLOAD (0x6100)	Firmware time level 5 overload Note: This fault cannot be reset.	Contact your local ABB representative.
0205	A1 OVERLOAD (0x6100)	Application time level 1 fault Note: This fault cannot be reset.	Contact your local ABB representative.
0206	A2 OVERLOAD (0x6100)	Application time level 2 fault Note: This fault cannot be reset.	Contact your local ABB representative.
0207	A1 INIT FAULT (0x6100)	Application task creation fault Note: This fault cannot be reset.	Contact your local ABB representative.
0208	A2 INIT FAULT (0x6100)	Application task creation fault Note: This fault cannot be reset.	Contact your local ABB representative.
0209	STACK ERROR (0x6100)	Drive internal fault Note: This fault cannot be reset.	Contact your local ABB representative.
0210	FPGA ERROR (0xFF61)	Drive internal fault Note: This fault cannot be reset.	Contact your local ABB representative.
0301	UFF FILE READ (0x6300)	File read error Note: This fault cannot be reset.	Contact your local ABB representative.
0302	APPL DIR CREATION (0x6100)	Drive internal fault Note: This fault cannot be reset.	Contact your local ABB representative.
0303	FPGA CONFIG DIR (0x6100)	Drive internal fault Note: This fault cannot be reset.	Contact your local ABB representative.
0304	PU RATING ID (0x5483)	Drive internal fault Note: This fault cannot be reset.	Contact your local ABB representative.
0305	RATING DATABASE (0x6100)	Drive internal fault Note: This fault cannot be reset.	Contact your local ABB representative.
0306	LICENSING (0x6100)	Drive internal fault Note: This fault cannot be reset.	Contact your local ABB representative.
0307	DEFAULT FILE (0x6100)	Drive internal fault Note: This fault cannot be reset.	Contact your local ABB representative.
0308	APPLFILE PAR (0x6300)	Corrupted application file Note: This fault cannot be reset.	Reload application. If fault is still active, contact your local ABB representative.

276 Fault tracing

Code	Fault (fieldbus code)	Cause	What to do
0309	APPL LOADING (0x6300)	Corrupted application file Note: This fault cannot be reset.	Reload application. If fault is still active, contact your local ABB representative.
0310	USERSET LOAD (0xFF69)	Loading of user set is not successfully completed because: - requested user set does not exist - user set is not compatible with drive program - drive has been switched off during loading.	Reload.
0311	USERSET SAVE (0xFF69)	User set is not saved because of memory corruption.	Check the setting of parameter 95.01 Ctrl boardSupply . If the fault still occurs, contact your local ABB representative.
0312	UFF OVERSIZE (0x6300)	UFF file is too big.	Contact your local ABB representative.
0313	UFF EOF (0x6300)	UFF file structure failure	Delete faulty file or contact your local ABB representative.
0314	TECH LIB INTERFACE (0x6100)	Incompatible firmware interface Note: This fault cannot be reset.	Contact your local ABB representative.
0315	RESTORE FILE (0x630D)	Restoration of backed-up parameters failed.	Contact your local ABB representative.
0316	DAPS MISMATCH (0x5484)	Mismatch between JCU Control Unit firmware and power unit logic versions.	Contact your local ABB representative.
0317	SOLUTION FAULT (0x6200)	Fault generated by function block SOLUTION_FAULT in the solution program.	Check the usage of the SOLUTION_FAULT block in the solution program.
0318	MENU HIDING (0x6200)	Menu hiding file missing or corrupted.	Reload application. Contact your local ABB representative.



Fieldbus control

What this chapter contains

The chapter describes how the drive can be controlled by external devices over a communication network (fieldbus).

System overview

The drive can be connected to a fieldbus controller via a fieldbus adapter module. The adapter module is installed into drive Slot 3.

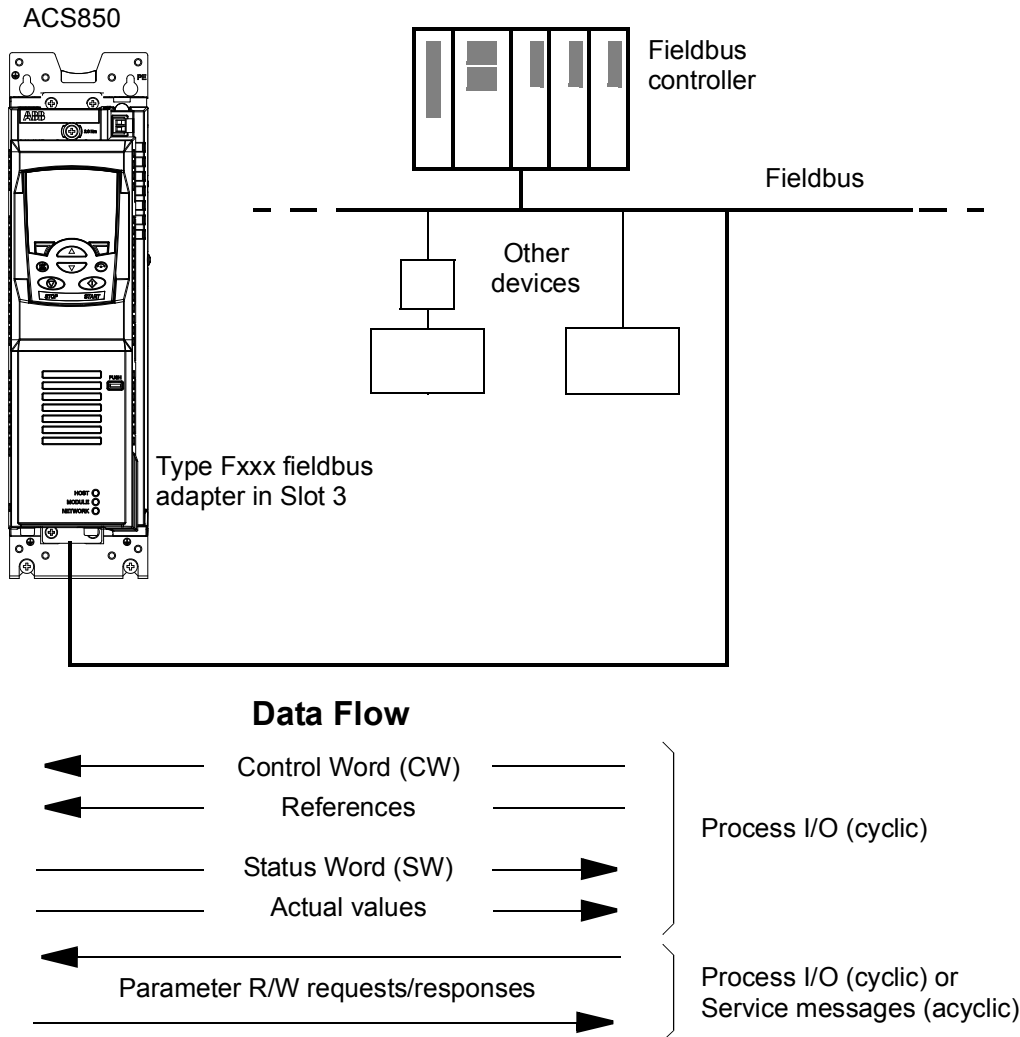

The drive can be set to receive all of its control information through the fieldbus interface, or the control can be distributed between the fieldbus interface and other available sources, for example digital and analogue inputs.

Fieldbus adapters are available for various serial communication protocols, for example

- PROFIBUS DP (FPBA-xx adapter)
- CANopen (FCAN-xx adapter)
- DeviceNet (FDNA-xx adapter)
- LONWORKS[®] (FLON-xx adapter).

Setting up communication through a fieldbus adapter module

Before configuring the drive for fieldbus control, the adapter module must be mechanically and electrically installed according to the instructions given in the User's Manual of the appropriate fieldbus adapter module.

The communication between the drive and the fieldbus adapter module is activated by setting parameter [50.01 Fba enable](#) to *Enable*. The adapter-specific parameters must also be set. See the table below.

Parameter	Setting for fieldbus control	Function/Information
COMMUNICATION INITIALISATION AND SUPERVISION (see also page 214)		
50.01 Fba enable	(1) <i>Enable</i>	Initialises communication between drive and fieldbus adapter module.
50.02 Comm loss func	(0) <i>No</i> (1) <i>Fault</i> (2) <i>Spd ref Safe</i> (3) <i>Last speed</i>	Selects how the drive reacts upon a fieldbus communication break.
50.03 Comm loss t out	0.3...6553.5 s	Defines the time between communication break detection and the action selected with parameter 50.02 Comm loss func .
50.04 Fba ref1 modesel and 50.05 Fba ref2 modesel	(0) <i>Raw data</i> (1) <i>Torque</i> (2) <i>Speed</i>	Defines the fieldbus reference scaling. When <i>Raw data</i> is selected, see also parameters 50.06...50.11 .
ADAPTER MODULE CONFIGURATION (see also page 216)		
51.01 FBA type	–	Displays the type of the fieldbus adapter module.
51.02 FBA par2 ••• 51.26 FBA par26	These parameters are adapter module-specific. For more information, see the <i>User's Manual</i> of the fieldbus adapter module. Note that not all of these parameters are necessarily used.	
51.27 FBA par refresh	(0) <i>Done</i> (1) <i>Refresh</i>	Validates any changed adapter module configuration parameter settings.
51.28 Par table ver	–	Displays the parameter table revision of the fieldbus adapter module mapping file stored in the memory of the drive.
51.29 Drive type code	–	Displays the drive type code of the fieldbus adapter module mapping file stored in the memory of the drive.

Parameter	Setting for fieldbus control	Function/Information
51.30 Mapping file ver	–	Displays the fieldbus adapter module mapping file revision stored in the memory of the drive.
51.31 D2FBA comm sta	–	Displays the status of the fieldbus adapter module communication.
51.32 FBA comm sw ver	–	Displays the common program revision of the adapter module.
51.33 FBA appl sw ver	–	Displays the application program revision of the adapter module.
Note: In the <i>User's Manual</i> of the fieldbus adapter module, the parameter group number is 1 or A for parameters 51.01 ... 51.26 .		
TRANSMITTED DATA SELECTION (see also page 217)		
52.01 FBA data in1 ... 52.12 FBA data in12	4...6 14...16 101...9999	Defines the data transmitted from drive to fieldbus controller. Note: If the selected data is 32 bits long, two parameters are reserved for the transmission.
53.01 FBA data out1 ... 53.12 FBA data out12	1...3 11...13 1001...9999	Defines the data transmitted from fieldbus controller to drive. Note: If the selected data is 32 bits long, two parameters are reserved for the transmission.
Note: In the <i>User's Manual</i> of the fieldbus adapter module, the parameter group number is 3 or C for parameters 52.01 ... 52.12 and 2 or B for parameters 53.01 ... 53.12 .		

After the module configuration parameters have been set, the drive control parameters (see section [Drive control parameters](#) below) must be checked and adjusted when necessary.

The new settings will take effect when the drive is powered up the next time (before powering off the drive, wait at least 1 minute), or when parameter [51.27 FBA par refresh](#) is activated.

Drive control parameters

The Setting for fieldbus control column gives the value to use when the fieldbus interface is the desired source or destination for that particular signal. The Function/Information column gives a description of the parameter.

Parameter	Setting for fieldbus control	Function/Information
CONTROL COMMAND SOURCE SELECTION		
<i>10.01 Ext1 start func</i>	(3) <i>FBA</i>	Selects fieldbus as the source for the start and stop commands when EXT1 is selected as the active control location.
<i>10.04 Ext2 start func</i>	(3) <i>FBA</i>	Selects fieldbus as the source for the start and stop commands when EXT2 is selected as the active control location.
<i>21.01 Speed ref1 sel</i>	(3) <i>FBA ref1</i> (4) <i>FBA ref2</i>	Fieldbus reference REF1 or REF2 is used as speed reference 1.
<i>21.02 Speed ref2 sel</i>	(3) <i>FBA ref1</i> (4) <i>FBA ref2</i>	Fieldbus reference REF1 or REF2 is used as speed reference 2.
<i>24.01 Torq ref1 sel</i>	(3) <i>FBA ref1</i> (4) <i>FBA ref2</i>	Fieldbus reference REF1 or REF2 is used as torque reference 1.
<i>24.02 Torq ref add sel</i>	(3) <i>FBA ref1</i> (4) <i>FBA ref2</i>	Fieldbus reference REF1 or REF2 is used as torque reference addition.
SYSTEM CONTROL INPUTS		
<i>16.07 Param save</i>	(0) <i>Done</i> (1) <i>Save</i>	Saves parameter value changes (including those made through fieldbus control) to permanent memory.

The fieldbus control interface

The cyclic communication between a fieldbus system and the drive consists of 16/32-bit input and output data words. The drive supports at the maximum the use of 12 data words (16 bits) in each direction.

Data transmitted from the drive to the fieldbus controller is defined by parameters [52.01 FBA data in1](#) ... [52.12 FBA data in12](#). The data transmitted from the fieldbus controller to the drive is defined by parameters [53.01 FBA data out1](#) ... [53.12 FBA data out12](#).

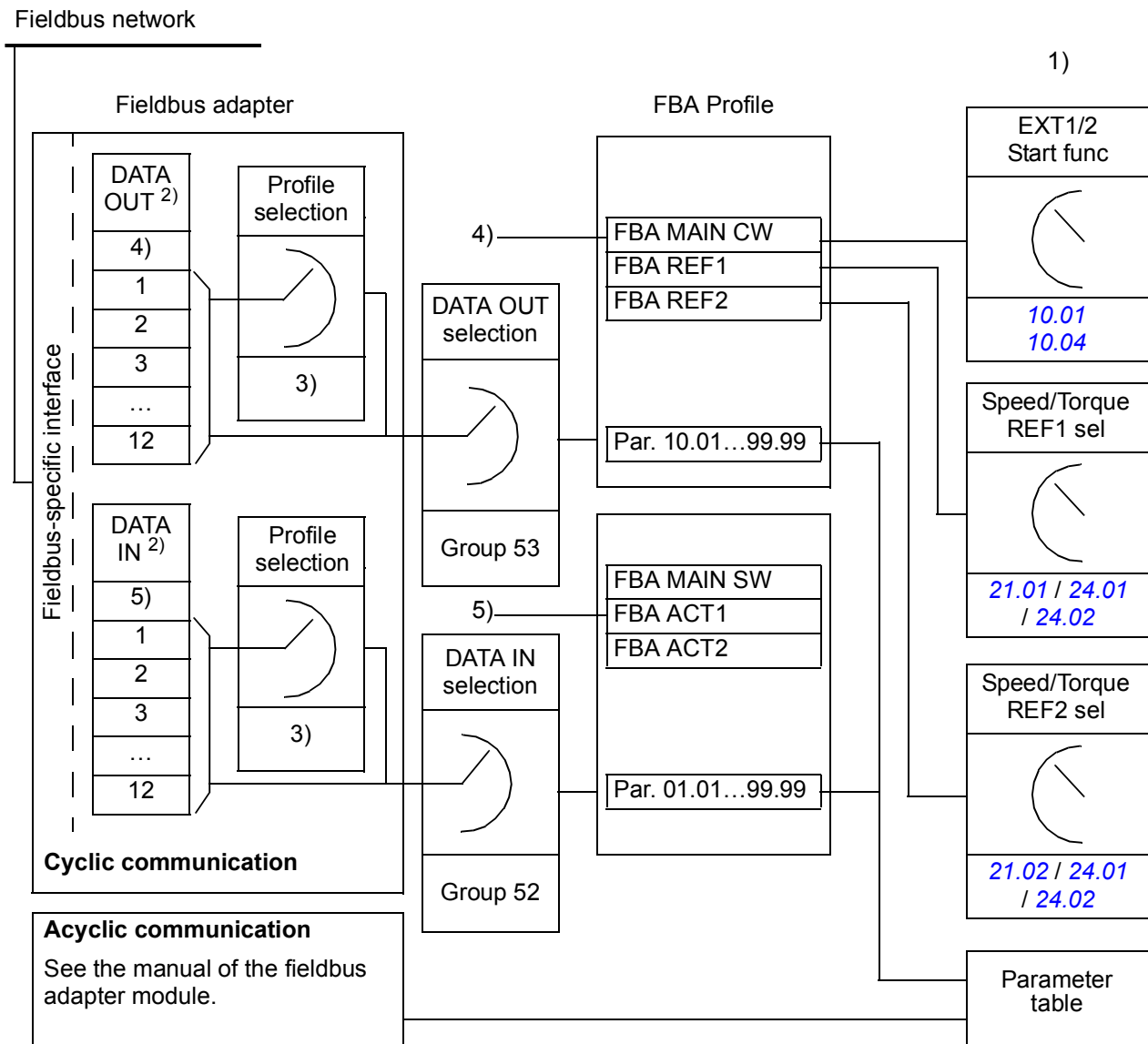

- 1) See also other parameters which can be controlled by the fieldbus.
- 2) The maximum number of used data words is protocol-dependent.
- 3) Profile/instance selection parameters. Fieldbus module specific parameters. For more information, see the *User's Manual* of the appropriate fieldbus adapter module.
- 4) With DeviceNet, the control part is transmitted directly.
- 5) With DeviceNet, the actual value part is transmitted directly.

■ The Control Word and the Status Word

The Control Word (CW) is the principal means of controlling the drive from a fieldbus system. The Control Word is sent by the fieldbus controller to the drive. The drive switches between its states according to the bit-coded instructions of the Control Word.

The Status Word (SW) is a word containing status information, sent by the drive to the fieldbus controller.

■ Actual values

Actual values (ACT) are 16/32-bit words containing information on selected operations of the drive.

FBA communication profile

The FBA communication profile is a state machine model which describes the general states and state transitions of the drive. The [State diagram](#) on page 285 presents the most important states (including the FBA profile state names). The FBA Control Word (parameter [02.24](#) – see page 99) commands the transitions between these states and the FBA Status Word (parameter [02.26](#) – see page 100) indicates the status of the drive.

Fieldbus adapter module profile (selected by adapter module parameter) defines how the control word and status word are transmitted in a system which consists of fieldbus controller, fieldbus adapter module and drive. With transparent modes, control word and status word are transmitted without any conversion between the fieldbus controller and the drive. With other profiles (e.g. PROFIdrive for FPBA-01, AC/DC drive for FDNA-01, DS-402 for FCAN-01 and ABB Drives profile for all fieldbus adapter modules) fieldbus adapter module converts the fieldbus-specific control word to the FBA communication profile and status word from FBA communication profile to the fieldbus-specific status word.

For descriptions of other profiles, see the User's Manual of the appropriate fieldbus adapter module.

■ Fieldbus references

References (FBA REF) are 16/32-bit signed integers. A negative reference (indicating reversed direction of rotation) is formed by calculating the two's complement from the corresponding positive reference value. The contents of each reference word can be used as torque or speed reference.

When torque or speed reference scaling is selected (by parameter [50.04 Fba ref1 modesel](#) / [50.05 Fba ref2 modesel](#)), the fieldbus references are 32-bit integers. The value consists of a 16-bit integer value and a 16-bit fractional value. The speed/torque reference scaling is as follows:

Reference	Scaling	Notes
Speed reference	FBA REF / 65536 (value in rpm)	Final reference is limited by parameters 20.01 Maximum speed , 20.02 Minimum speed and 21.09 SpeedRef min abs .
Torque reference	FBA REF / 65536 (value in %)	Final reference is limited by torque limit parameters 20.06...20.10 .

■ State diagram

The following presents the state diagram for the FBA communication profile. For other profiles, see the User's Manual of the appropriate fieldbus adapter module.

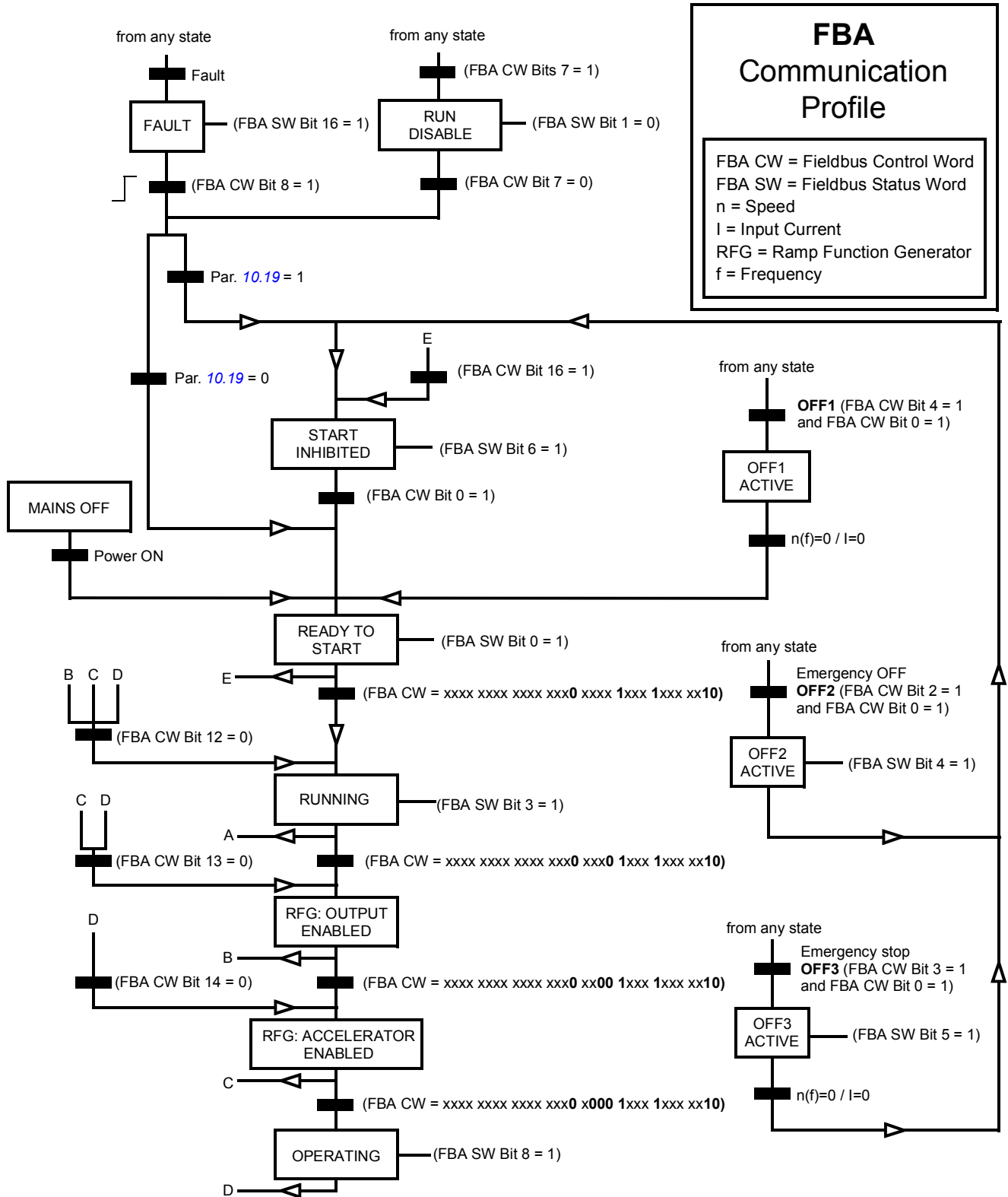



Control block diagrams

What this chapter contains

The chapter contains a graphical representation of the control program.

Speed feedback

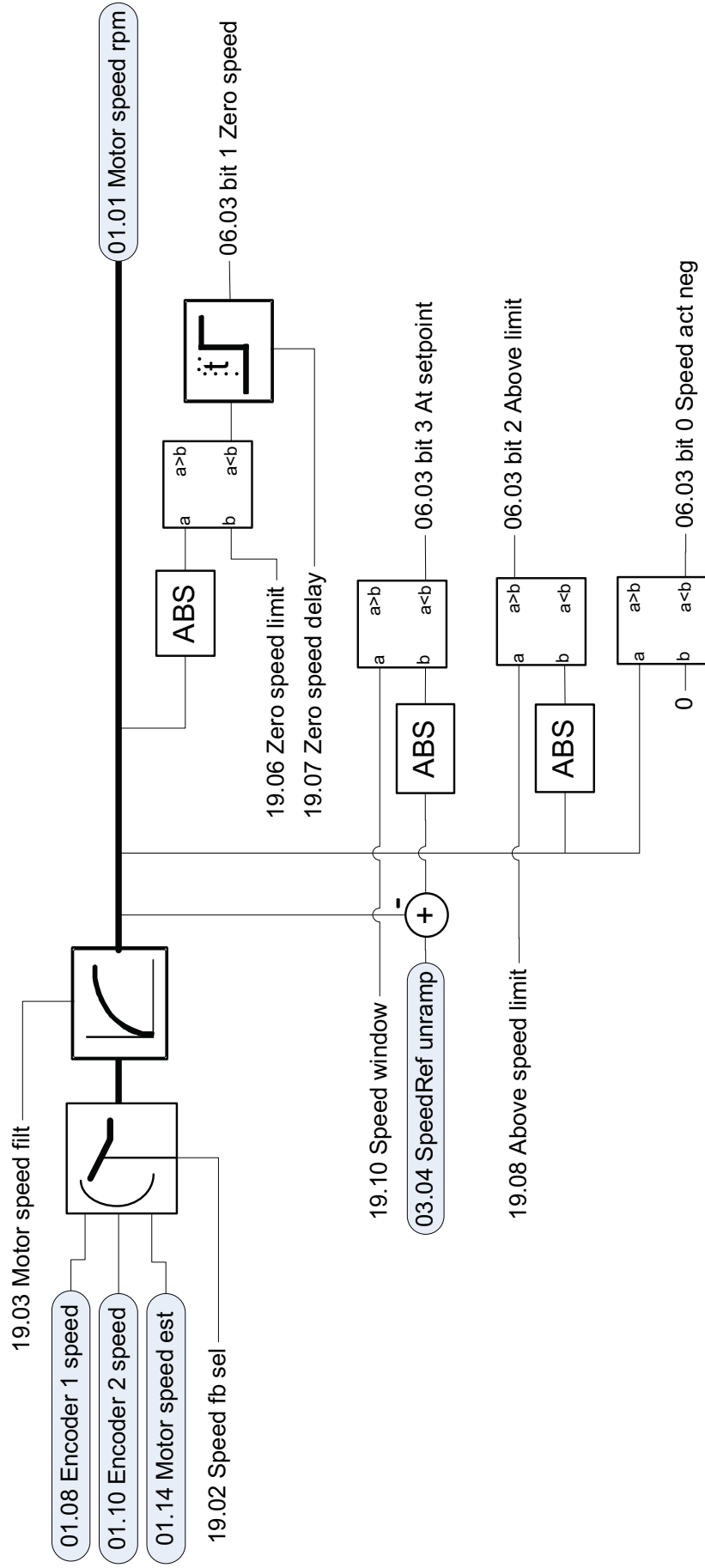

Speed reference modification and ramping

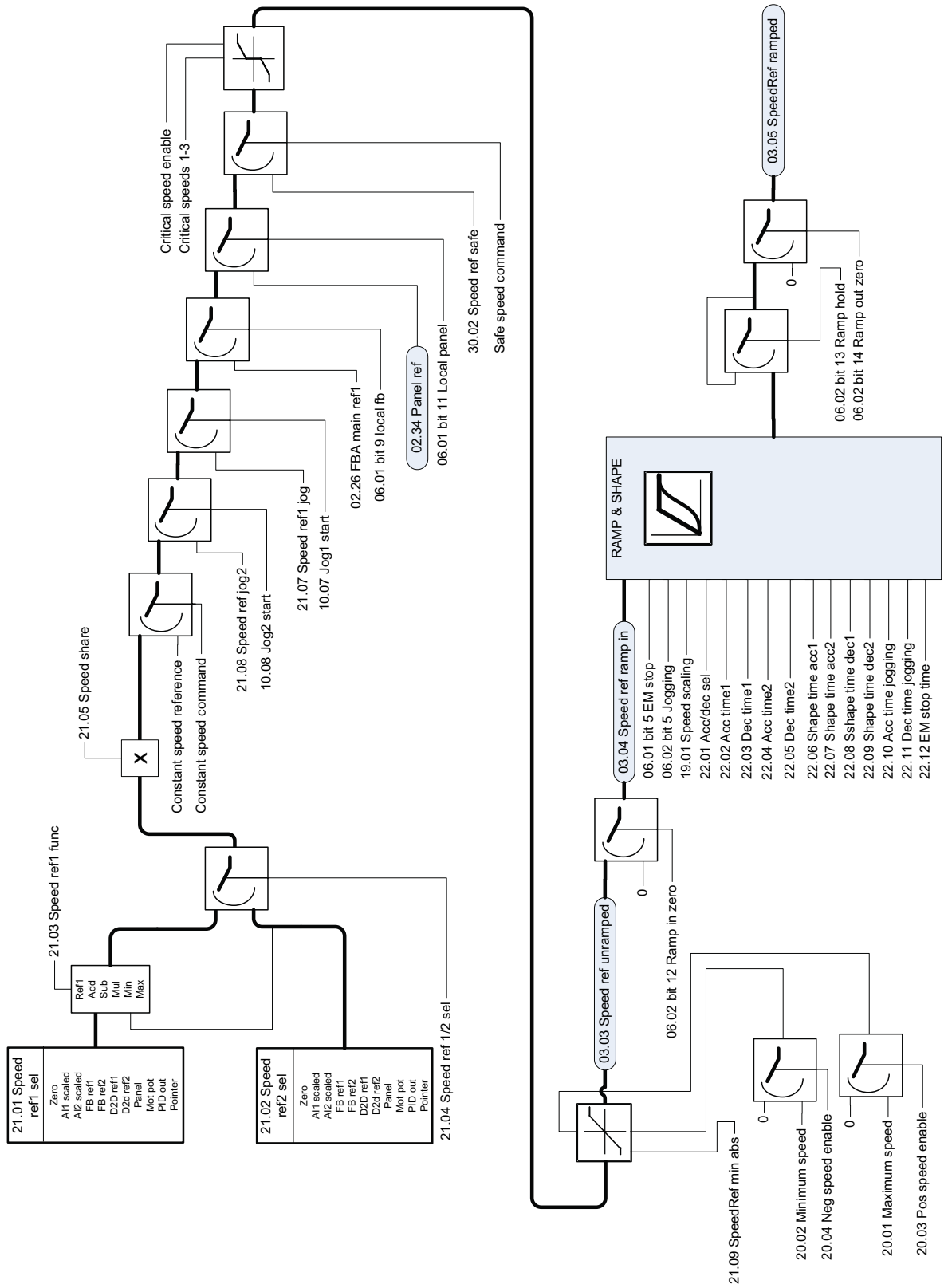

Speed error handling

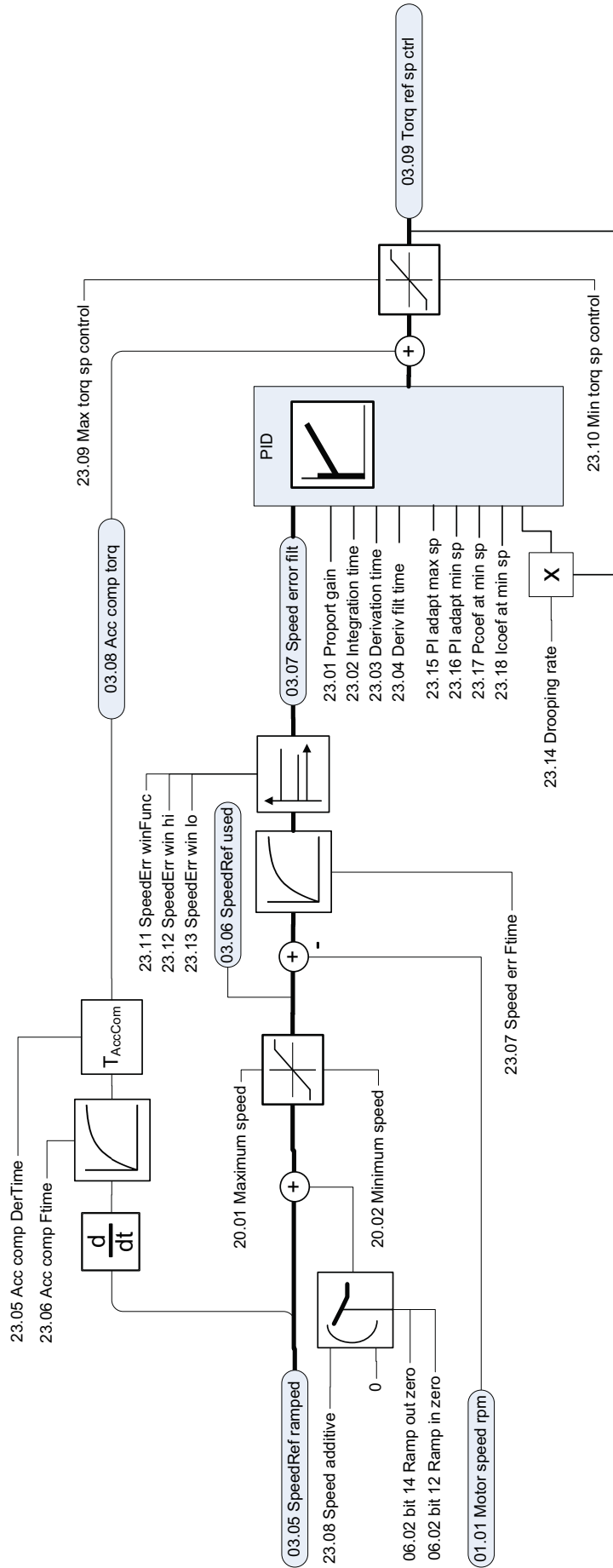

Torque reference modification, operating mode selection

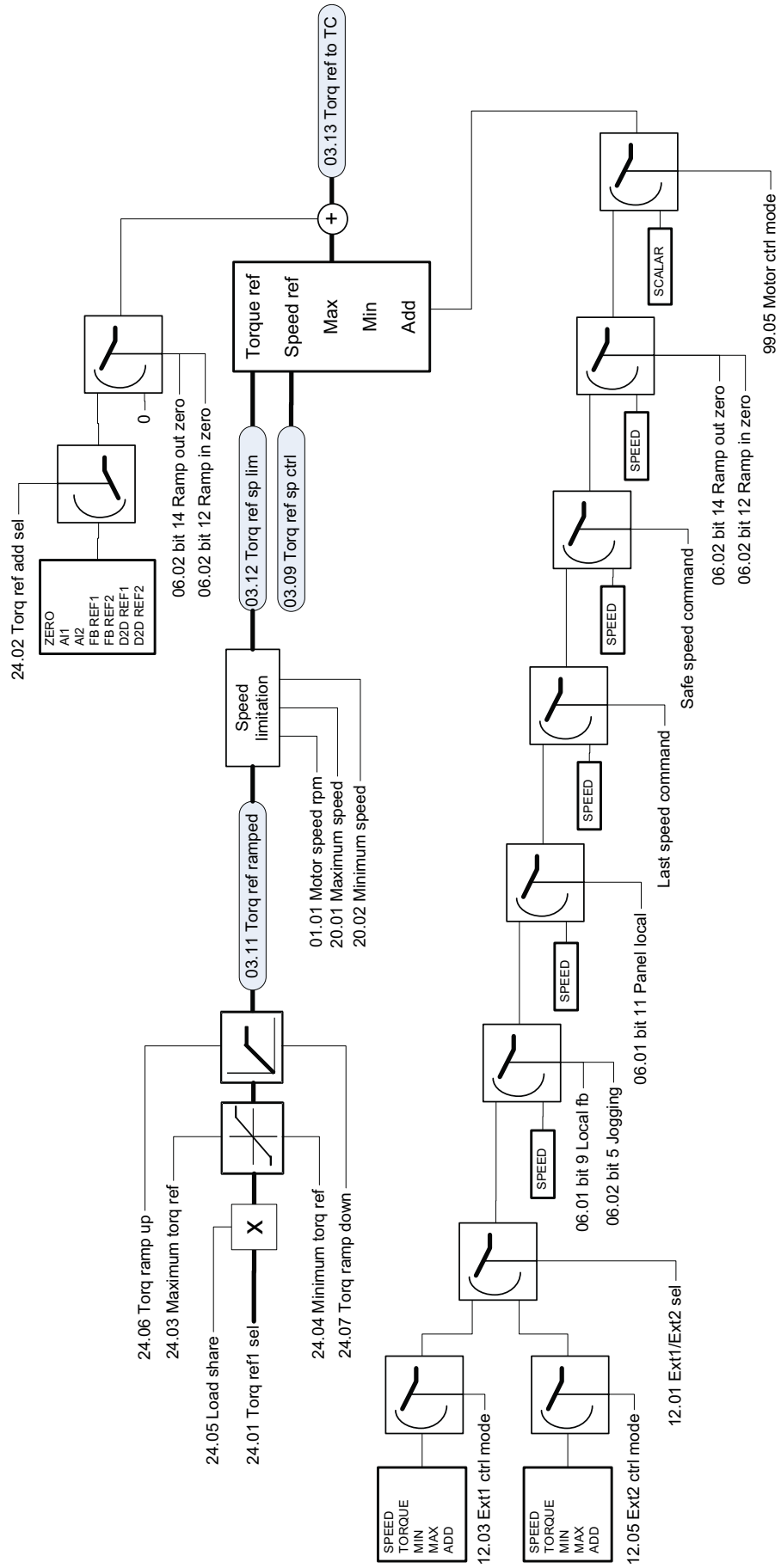

Process PID

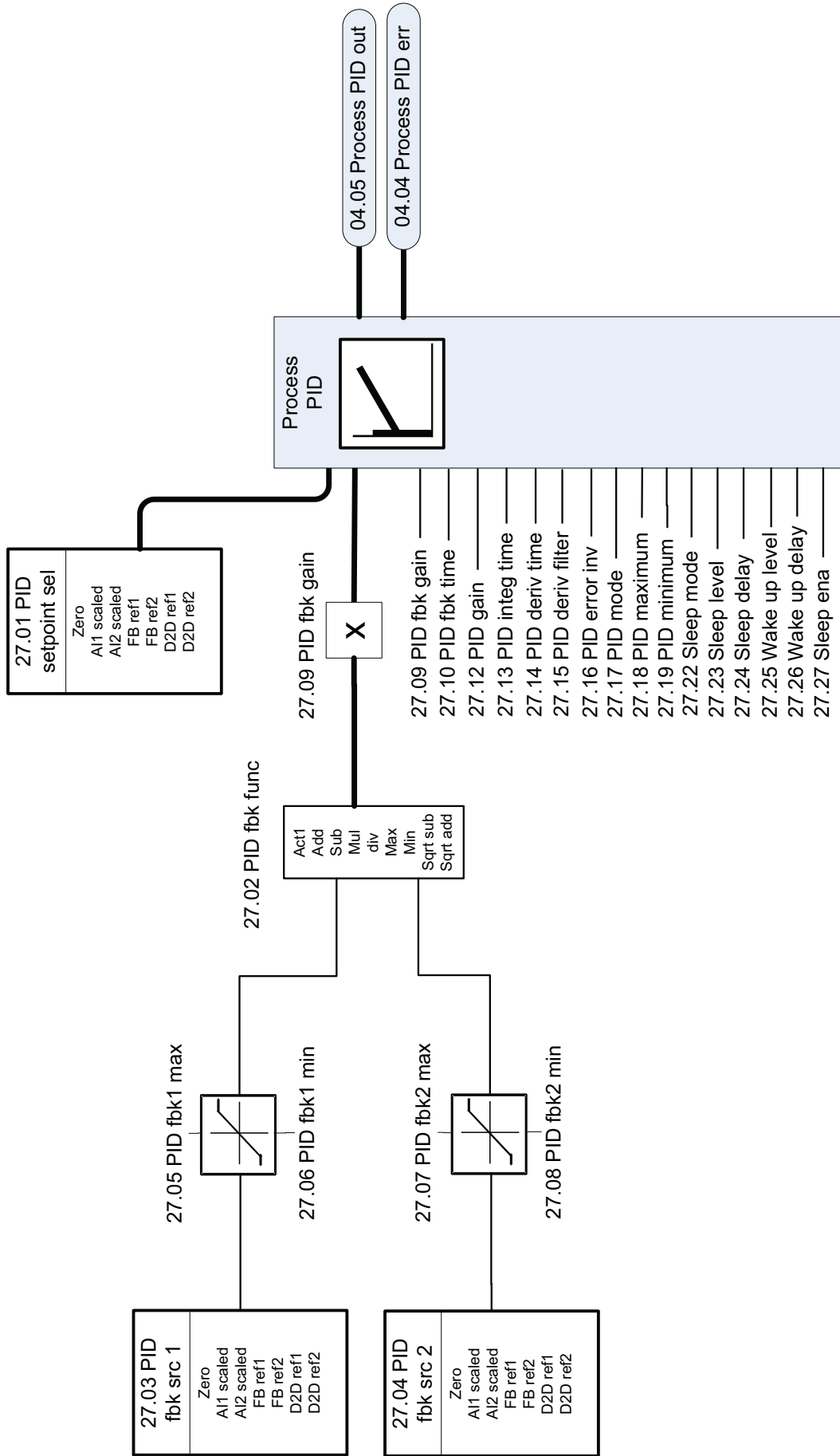

Direct torque control

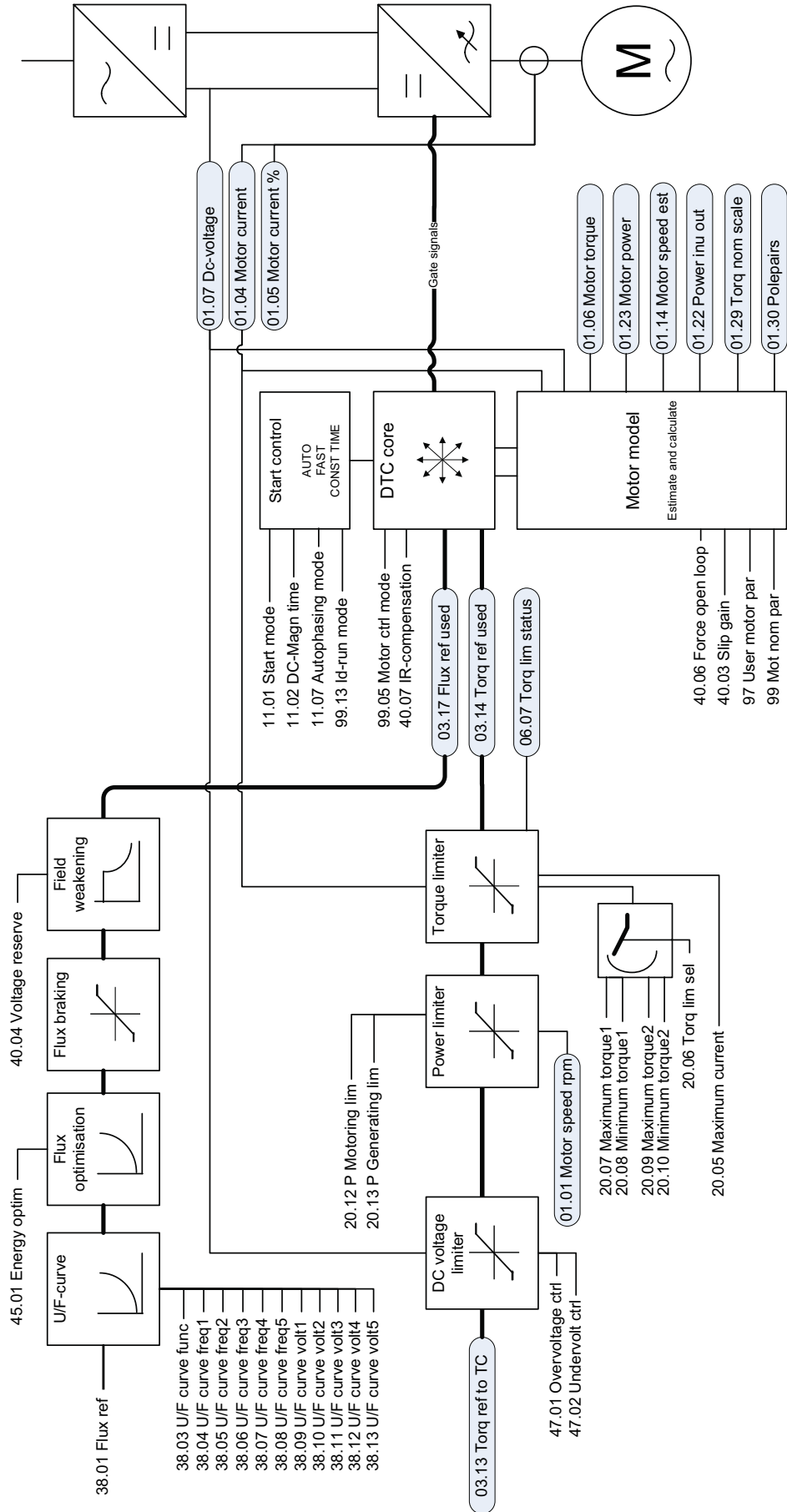

Further information

Product and service inquiries

Address any inquiries about the product to your local ABB representative, quoting the type designation and serial number of the unit in question. A listing of ABB sales, support and service contacts can be found by navigating to www.abb.com/drives and selecting *Sales, Support and Service network*.

Product training

For information on ABB product training, navigate to www.abb.com/drives and select *Training courses*.

Providing feedback on ABB Drives manuals

Your comments on our manuals are welcome. Go to www.abb.com/drives and select *Document Library – Manuals feedback form (LV AC drives)*.

Document library on the Internet

You can find manuals and other product documents in PDF format on the Internet. Go to www.abb.com/drives and select *Document Library*. You can browse the library or enter selection criteria, for example a document code, in the search field.



3AUA0000045497 Rev C / EN
EFFECTIVE: 2009-07-20

ABB Oy
AC Drives
P.O. Box 184
FI-00381 HELSINKI
FINLAND
Telephone +358 10 22 11
Fax +358 10 22 22681
Internet <http://www.abb.com>

ABB Inc.
Automation Technologies
Drives & Motors
16250 West Glendale Drive
New Berlin, WI 53151 USA
Telephone 262 785-3200
800-HELP-365
Fax 262 780-5135

ABB Beijing Drive Systems Co. Ltd.
No. 1, Block D, A-10 Jiuxianqiao Beilu
Chaoyang District
Beijing, P.R. China, 100015
Telephone +86 10 5821 7788
Fax +86 10 5821 7618
Internet <http://www.abb.com>